



ATHENA 3 PR/M

SKU: 01000ATH3MPR

Buffet refrigerado de sobremesa con estructura de madera laminada. Capacidad 3 GN 1/1. Protector contra estornudos de plexiglás con sistema de movimiento eléctrico. Encimera Hanex con perfil de plexiglás para un mejor comportamiento en frío. gasolina R290. Termostato digital (2°/ 8°) e iluminación con LED. Dos ruedas de poliamida con freno incluido.



Ø75

GN

3 GN 1/1 fino a h.200



230V



3



2

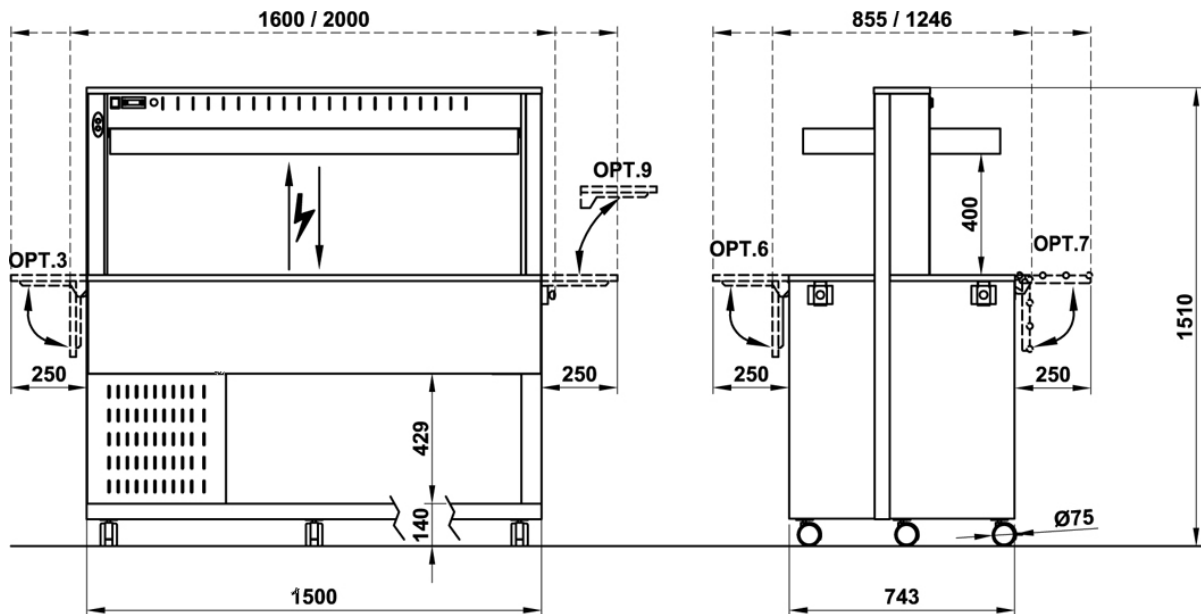



ATHENA 4 PR/M

SKU: 01000ATH3MPR

Buffet refrigerado de sobremesa con estructura de madera laminada. Capacidad 4 GN 1/1. Protector contra estornudos de plexiglás con sistema de movimiento eléctrico. Encimera Hanex con perfil de plexiglás para un mejor comportamiento en frío. gasolina R290. Termostato digital (2°/ 8°) e iluminación con LED. Dos ruedas de poliamida con freno incluido.



Ø75

GN

4 GN 1/1 hasta h.200



230V



3



2

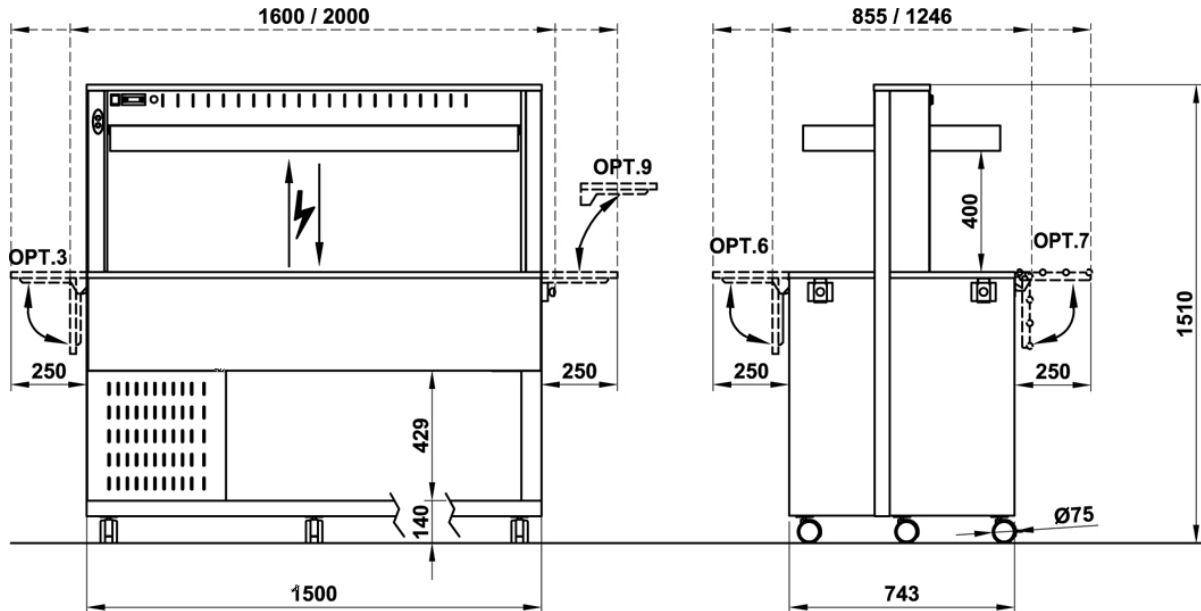



ATHENA 5 PR/M

SKU: 01000ATH3MPR

Buffet refrigerado de sobremesa con estructura de madera laminada. Capacidad 5 GN 1/1. Protector contra estornudos de plexiglás con sistema de movimiento eléctrico. Encimera Hanex con perfil de plexiglás para un mejor comportamiento en frío. gasolina R290. Termostato digital (2°/ 8°) e iluminación con LED. Dos ruedas de poliamida con freno incluido.



Ø75



605,5 W



4



2

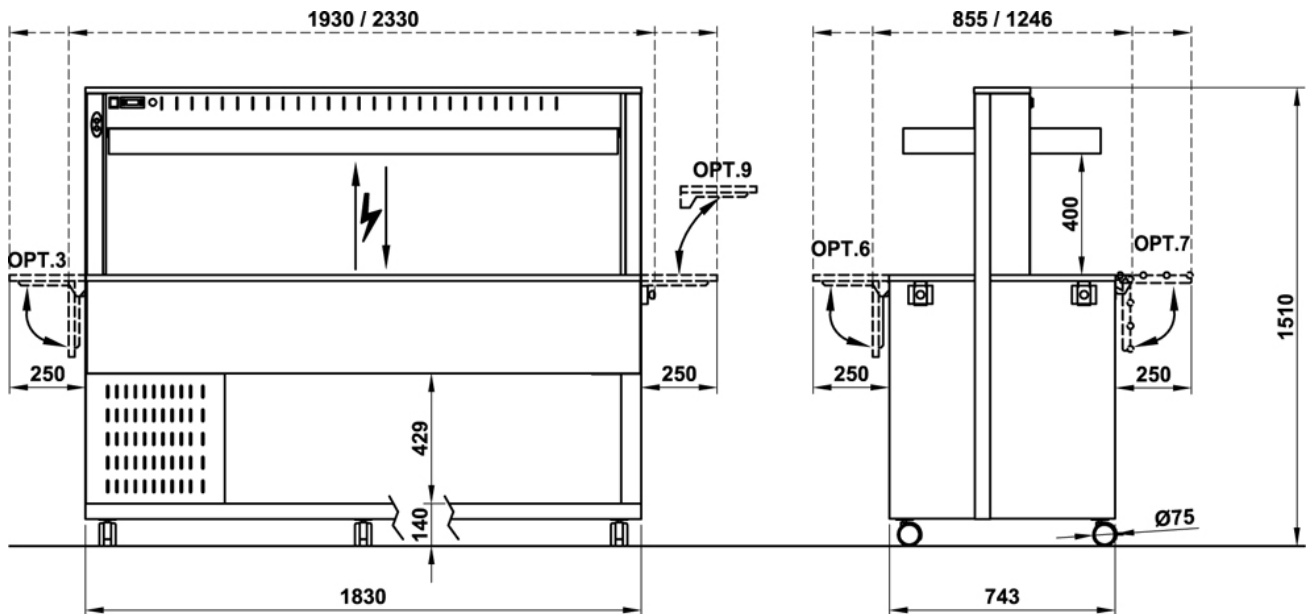

Optional/Options

OPT. 3 SP



Porta-plateos lateral plegable

OPT. 3-TUB SP



Porte-assiettes latéral rabattable

OPT. 3-SST SP



Portaplateos lateral plegable - Acero inoxidable

OPT. 4 SP

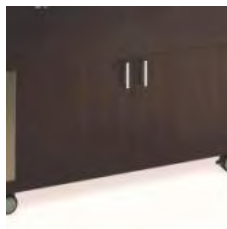

Compartimento inferior neutro con puertas, módulos cálidos

OPT. 6 SP



Porta-plateos plegable

OPT. 7 SP



Porta-bandejas plegable

OPT. 8 SP



Porta-bandejas plegable

OPT. 9-A SP



Porta-plateos lateral por isla self, retirable

OPT. 9-TUBA SP



Porta-bandejas lateral por isla self, retirable

OPT. 9-SSTA SP



Porta-bandejas lateral por isla self, retirable

OPT. 9-C SP



Porta-plateos lateral por módulo a pared, retirable

OPT. 9C-TUBA SP



Porta-bandejas lateral por módulo a pared, retirable

OPT. 9C-SSTA SP



Porta-bandejas lateral por módulo a pared, retirable

OPT. 10 SP



Roues renforcées diam.125mm en acier, dont 2 à frein

OPT. 11/LAM SP



Recargo por encimera de contraste en color madera laminada (Emparejamiento sugeridos LBE, LOM, LNO)

OPT. 11/FO SP



Encimera contrastada de Formica

OPT. 14/F SP



Intermediate floor, compartment mod. refrigerated

OPT. 15-F/LAM SP

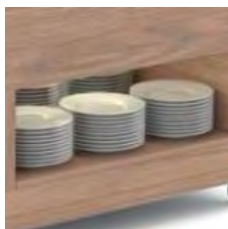

Nicho para módulos refrigerados - Madera laminada

OPT. 15-F/FO SP



Nicho para módulos refrigerados - Formica

OPT. 16/LAM SP



Estante superior con mayor profundidad y borde posterior de contención - Madera laminada

OPT. 16/FO SP



Estante superior con mayor profundidad y borde posterior de contención - Formica

OPT. UK SP



Recargo por enchufe UK

OPT. 17 SP



Módulo personalizado intermedio

OPT. ADS SP



Adhesivo por personalización

OPT. 17CH SP



Módulo de cabeza a medida

OPT. HZ6 SP



Suplemento compresor 60Hz

OPT. PZ SP



Pies

OPT. 45CUT SP



Corte a 45°

OPT. Z SP



Zócalo con pies de PVC revestido de aluminio

Finiture/Finishes

LAR - PLATA



PLATA

LRS - ROSADO



LZA - AZAFRAN



LIM - LIME



LSK - CIELO

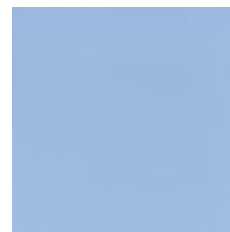

CIELO

LOC - OCÉANO

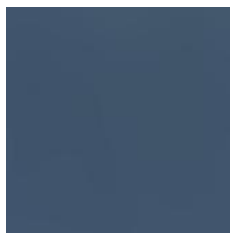

OCÉANO

LER - HIEDRA

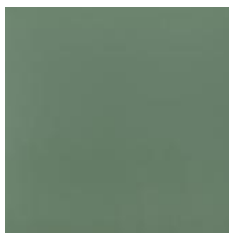

HIEDRA

LSV - SALVIA



SALVIA

LCP - CAPPUCCINO



CAPPUCCINO

LTC - TERRACOTA

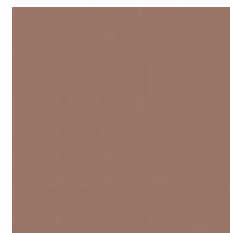

TERRACOTA

LGR - GRIS



LNI - NIAGARA



NIAGARA

LBV - BLANCO VETEADO



LWS - ARENA BLANCA



ARENA BLANCA

LBE - ABEDUL

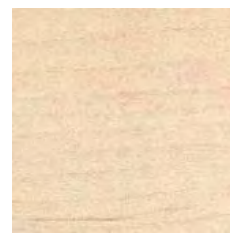

LNE - NIEBLA



LOM - OLMO

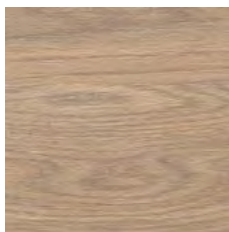

LNO - NOGAL

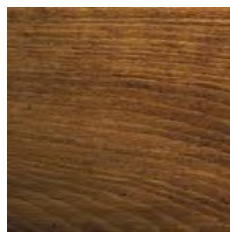

LWE - WENGE'

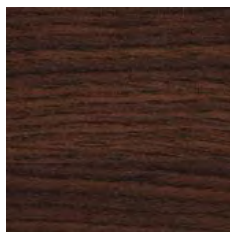

LAN - ANTRACITA

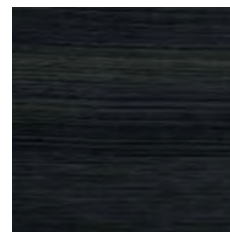

LNV - NEGRO VETEADO

