

## ACCESORIOS INCLUIDOS

REF.	DESCRIPCIÓN
950.004	Pinzas para carne TOP 400 mm
950.001	Atizador
900.045	Parrilla varilla 70 (585x465)
902.945	Mesa Frontal Inox 29 cm 70 ED



PARRILLA VARILLA



PINZAS PARA CARNE TOP 400 MM



ATIZADOR



MESA FRONTAL INOX 29 CM



Restaurante Bardal en Ronda (Malaga) by chef Benito Gomez (2 estrellas Michelin)

## ACCESORIOS

REF.	DESCRIPCIÓN
750.001	Aro acoplador
750.002	Regulador de tiro externo
750.003	Cortallamas externo*
750.004	Sombrero Inox
750.005	Adaptador
*Kit Chimenea con Cortallamas externo obligatorio. Info pag 42/43	
901.045	Parrilla acanalada 70 (515x470)
960.045	Plancha 70 (525x470)
965.070	Soporte pinchos 70 (capacidad 8 u.)
961.070	Lámina para Pizzas 70 (570x430)
955.070	Pinchos 70
950.005	Pinzas para carne 330 mm
920.045	Bandeja Calientaplatos 70
924.045	Bandeja Calientaplatos 70 ED
904.045	Mesa Frontal 40 cm 70 ED
770.245	Mesa Carbonera Pira 70
770.345	Mesa Carbonera Pira 70 SILVER



PARRILLA ACANALADA



PLANCHA



SOPORTE PINCHOS



BANDEJA CALIENTAPLATOS



MESA CARBONERA PIRA 70



MESA CARBONERA PIRA 70 SILVER

Hosteleria10.com



LÁMINA PARA PIZZAS 70



PINZAS PARA CARNE 330 MM

## ACCESORIOS INCLUIDOS

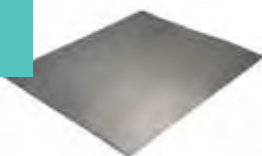
REF.	DESCRIPCIÓN
950.004	Pinzas para carne TOP 400 mm
950.001	Atizador
900.048	Parrilla varilla 70 XL (585x535)
902.945	Mesa Frontal Inox 29 cm 70/70xl ED



PARRILLA VARILLA



PINZAS PARA CARNE TOP 400 MM



ATIZADOR

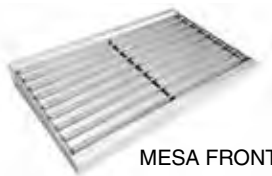

MESA FRONTAL INOX 29 CM 70/70xl ED



PIRA assessor chef en aula de formación de la empresa.

## ACCESORIOS

REF.	DESCRIPCIÓN
750.001	Aro acoplador
750.002	Regulador de tiro externo
750.003	Cortallamas externo*
750.004	Sombrero Inox
750.005	Adaptador
*Kit Chimenea con Cortallamas externo obligatorio. Info pag 42/4	
901.048	Parrilla acanalada 70 XL (515x540)
960.048	Plancha 70 XL (525x540)
965.077	Soporte pinchos 70 XL (capacidad 8 u.)
961.048	Lámina para Pizzas 70 XL (570x500)
955.080	Pinchos 70xl/80
950.005	Pinzas para carne 330 mm
920.048	Bandeja Calientaplatos 70 XL
924.048	Bandeja Calientaplatos 70 XL ED
904.045	Mesa Frontal 40 cm 70/70xl ED
770.248	Mesa Carbonera Pira 70 XL
770.348	Mesa Carbonera Pira 70 XL SILVER



PARRILLA ACANALADA



PLANCHA



SOPORTE PINCHOS



BANDEJA CALIENTAPLATOS



MESA CARBONERA  
PIRA 70 XL



MESA CARBONERA  
PIRA 70 XL SILVER



LÁMINA PARA PIZZAS 70 XL



PINZAS PARA CARNE 330 MM

## ACCESORIOS INCLUIDOS

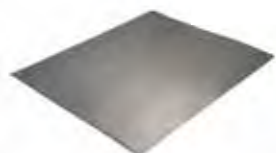
REF.	DESCRIPCIÓN
950.004	Pinzas para carne TOP 400 mm
950.001	Atizador
900.049	Parrilla varilla 80 (685x535)
902.949	Mesa Frontal Inox 29 cm 80 ED



PINZAS PARA CARNE TOP 400 mm



ATIZADOR



PARRILLA VARILLA



MESA FRONTAL INOX 29 CM



Detalle #Pira80SilverEd en Starlite Festival 2021 en Marbella

## ACCESORIOS

REF.	DESCRIPCIÓN
750.001	Aro acoplador
750.002	Regulador de tiro externo
750.003	Cortallamas externo*
750.004	Sombrero Inox
750.005	Adaptador
*Kit Chimenea con Cortallamas externo obligatorio. Info pag 42/43	
901.049	Parrilla acanalada 80 (615x540)
960.049	Plancha 80 (625x545)
965.080	Soporte pinchos 80 (capacidad 9 u.)
961.080	Lámina para Pizzas 80 (660x500)
970.049	Separador 80 4 guías
970.249	Separador 80 7 guías
900.492	1/2 Parrilla varilla 80 (330x545)
901.492	1/2 Parrilla acanalada 80 (230x540)
960.492	1/2 Plancha 80 (230x545)
955.080	Pinchos 70xl/80
950.005	Pinzas para carne 330 mm
920.049	Bandeja Calientaplatos 80
924.049	Bandeja Calientaplatos 80 ED
904.049	Mesa Frontal 40 cm 80 ED
770.249	Mesa Carbonera Pira 80
770.349	Mesa Carbonera Pira 80 SILVER



PARRILLA ACANALADA



PLANCHA



SOPORTE PINCHOS



SOPORTE PINCHOS POLLO



PINZAS PARA CARNE 330 MM



SEPARADOR 80 (4 GUIAS)



MESA CARBONERA PIRA 80



MESA CARBONERA PIRA 80 SILVER

## ACCESORIOS INCLUIDOS

REF.	DESCRIPCIÓN
950.004	Pinzas para carne TOP 400 mm
950.001	Atizador
900.050	Parrilla varilla 90 (780x625)
904.050	Mesa Frontal Inox 40 cm 90 ED



PINZAS PARA CARNE TOP 400 mm



ATIZADOR



PARRILLA VARILLA



MESA FRONTAL INOX 40 CM



Detalle cocina Restaurante Foier des Guides en Valtournenche (Alpes Italianos)

## ACCESORIOS

REF.	DESCRIPCIÓN
750.001	Aro acoplador
750.002	Regulador de tiro externo
750.003	Cortallamas externo*
750.004	Sombrero Inox
750.005	Adaptador
*Kit Chimenea con Cortallamas externo obligatorio. Info pag 42/43	
901.050	Parrilla acanalada 90 (780x625)
960.050	Plancha 90 (700x585)
965.090	Soporte pinchos 90 (capacidad 11 u.)
965.020	Soporte pinchos Pollo 90 (capacidad 4 u.)
961.090	1/2 Lámina para Pizzas 90 (370x590)
970.050	Separador 90 4 guías
970.052	Separador 90 7 guías
900.052	1/2 Parrilla varilla 90 (385x625)
901.052	1/2 Parrilla acanalada 90 (300x585)
960.052	1/2 Plancha 90 (325x587)
965.092	1/2 Soporte pinchos 90 (capacidad 4u.)
955.090	Pinchos 90/120
955.120	Pinchos Pollo 90/120
950.005	Pinzas para carne 330 mm
920.050	Bandeja Calientaplatos 90
924.050	Bandeja Calientaplatos 90 ED
902.950	Mesa Frontal 29 cm 90 ED
770.250	Mesa Carbonera Pira 90
770.350	Mesa Carbonera Pira 90 SILVER



PARRILLA ACANALADA



PLANCHA



SOPORTE PINCHOS



SOPORTE PINCHOS POLLO

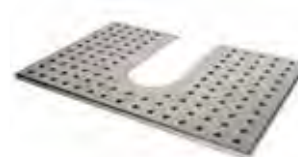

BANDEJA CALIENTAPLATOS



SEPARADOR 90 (4 GUIAS)



MESA CARBONERA PIRA 90



MESA CARBONERA PIRA 90 SILVER



PINZAS PARA CARNE 330 MM

## ACCESORIOS INCLUIDOS

REF.	DESCRIPCIÓN
950.004	Pinzas para carne TOP 400 mm
950.001	Atizador
900.050	Parrilla varilla 90 (780x625)
904.150	Mesa Frontal Inox 18 cm 90 ED



PARRILLA VARILLA



PINZAS PARA CARNE TOP 4000



ATIZADOR



MESA FRONTAL INOX 40 CM



Detalle cocina Restaurante Ara Bracis en Roma

## ACCESORIOS

REF.	DESCRIPCIÓN
759.007	Cortallamas Externo* 90D
759.008	Sombrero Inox 90D
*Kit Chimenea con Cortallamas externo obligatorio. Info pag 42/43	
901.050	Parrilla acanalada 90 (780x625)
960.050	Plancha 90 (700x585)
965.090	Soporte pinchos 90 (capacidad 11 u.)
965.020	Soporte pinchos Pollo 90 (capacidad 4 u.)
961.090	1/2 Lámina para Pizzas 90 (370x590)
970.050	Separador 90 4 guías
970.052	Separador 90 7 guías
900.052	1/2 Parrilla varilla 90 (385x625)
901.052	1/2 Parrilla acanalada 90 (300x585)
960.052	1/2 Plancha 90 (325x587)
965.092	1/2 Soporte pinchos 90 (capacidad 4u.)
955.090	Pinchos 90/120
955.120	Pinchos Pollo 90/120
950.005	Pinzas para carne 330 mm
924.050	Bandeja Calientaplatos 90 ED



PARRILLA ACANALADA



PLANCHA



SOPORTE PINCHOS



SOPORTE PINCHOS POLLO

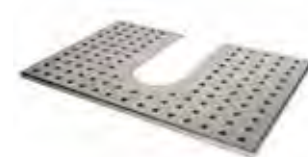

BANDEJA CALIENTAPLATOS



SEPARADOR 90 (4 GUIAS)



1/2 PARRILLA VARILLA

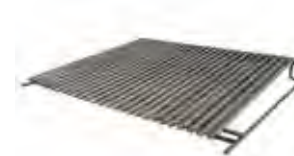

1/2 PARRILLA ACANALADA

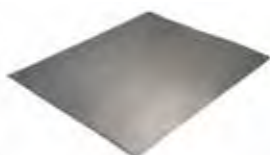

1/2 LÁMINAS PARA PIZZA



PINZAS PARA CARNE 300 MM

## ACCESORIOS INCLUIDOS

REF.	DESCRIPCIÓN
950.004	Pinzas para carne TOP 400 mm
950.008	Atizador
900.120	Parrilla varilla 120 (1060x625)
904.012	Mesa Frontal Inox 40 cm 120 ED



PARRILLA VARILLA



PINZAS PARA CARNE TOP 400 MM



ATIZADOR



MESA FRONTAL INOX 40 CM



## ACCESORIOS

REF.	DESCRIPCIÓN
750.007	Cortallamas Externo* 120
750.008	Sombrero Inox 120
*Kit Chimenea con Cortallamas externo obligatorio. Info pag 42/43	
901.120	Parrilla acanalada 120 (990x625)
965.120	Soporte pinchos 120 (capacidad 15 u.)
965.021	Soporte pinchos Pollo 120 (capacidad 5 u.)
961.120	1/2 Lámina para pizzas 120 (520x590)
970.120	Separador 120 4 guías
970.122	Separador 120 6 guías
900.122	1/2 Parrilla varilla 120 (535x625)
901.122	1/2 Parrilla acanalada 120 (460x585)
960.122	1/2 Plancha 120 (458x590)
965.122	1/2 Soporte pinchos 120 (capacidad 6u.)
955.090	Pinchos 90/120
955.120	Pinchos Pollo 90/120
950.005	Pinzas para carne 330 mm
920.120	Bandeja Calientaplatos 120
924.120	Bandeja Calientaplatos 120 ED
902.912	Mesa Frontal 29 cm 120 ED
770.220	Mesa Carbonera Pira 120
770.320	Mesa Carbonera Pira 120 SILVER



PARRILLA ACANALADA



1/2 PLANCHA



SOPORTE PINCHOS



SOPORTE PINCHOS POLLO



BANDEJA CALIENTAPLATOS



SEPARADOR 120 (4 GUIAS)

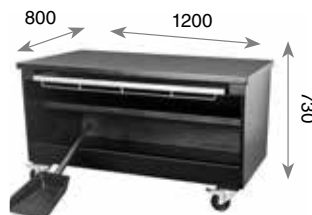

MESA CARBONERA PIRA 120



MESA CARBONERA PIRA 120 SILVER

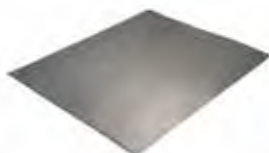

1/2 LÁMINA PARA PIZZAS 120



PINZAS PARA CARNE 330 MM

## ACCESORIOS INCLUIDOS

REF.	DESCRIPCIÓN
950.004	Pinzas para carne TOP 400 mm
950.008	Atizador
900.120	Parrilla varilla 120 (1060x625)



PARRILLA VARILLA



PINZAS PARA CARNE TOP 400 mm



ATIZADOR



MESA FRONTAL INOX 40 CM



## ACCESORIOS

REF.	DESCRIPCIÓN
750.007	Cortallamas Externo* 120
750.008	Sombrero Inox 120
*Kit Chimenea con Cortallamas externo obligatorio. Info pag 42/43	
901.120	Parrilla acanalada 120 (990x625)
965.120	Soporte pinchos 120 (capacidad 15 u.)
965.021	Soporte pinchos Pollo 120 (capacidad 5 u.)
961.120	1/2 Lámina para Pizzas 120 (520x590)
970.120	Separador 120 4 guías
970.122	Separador 120 6 guías
900.122	1/2 Parrilla varilla 120 (535x625)
901.122	1/2 Parrilla acanalada 120 (460x585)
960.122	1/2 Plancha 120 (458x590)
965.122	1/2 Soporte pinchos 120 (capacidad 6u.)
955.090	Pinchos 90/120
955.120	Pinchos Pollo 90/120
950.005	Pinzas para carne 330 mm
924.120	Bandeja Calientaplatos 120 ED



PARRILLA ACANALADA



1/2 PLANCHA



SOPORTE PINCHOS



PINCHOS POLLO



PINCHOS



BANDEJA CALIENTAPLATOS



SEPARADOR 120 (4 GUIAS)

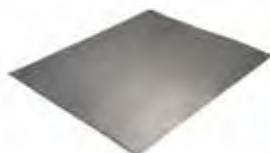

1/2 LÁMINA PARA PIZZAS



PINZAS PARA CARNE 330 MM

## ACCESORIOS INCLUIDOS

REF.	DESCRIPCIÓN
950.005	Pinzas para carne 330 mm
950.001	Atizador
900.045	Parrilla varilla 70 (585x465)
902.945	Mesa Frontal Inox 29 cm 70 ED



PARRILLA VARILLA



PINZAS PARA CARNE 330 mm



ATIZADOR



MESA FRONTAL INOX 29 CM



Diego Gallegos, "el chef del caviar" en la cocina del Restaurante Sollo, 1 estrella Michelin en Fuengirola

## ACCESORIOS

REF.	DESCRIPCIÓN
750.001	Aro acoplador
750.002	Regulador de tiro externo
750.003	Cortallamas externo*
750.004	Sombrero Inox
750.005	Adaptador
*Kit Chimenea con Cortallamas externo obligatorio. Info pag 42/43	
901.045	Parrilla acanalada 70 (515x470)
960.045	Plancha 70 (525x470)
965.070	Soporte pinchos 70 (capacidad 8 u.)
961.070	Lámina para Pizzas 70 (570x430)
955.070	Pinchos 70
950.004	Pinzas para carne TOP 400 mm
920.045	Bandeja Calientaplatos 70
924.045	Bandeja Calientaplatos 70 ED
904.045	Mesa Frontal 40 cm 70 ED
770.245	Mesa Carbonera Pira 70
770.345	Mesa Carbonera Pira 70 SILVER



PARRILLA ACANALADA



PLANCHA



SOPORTE PINCHOS



BANDEJA CALIENTAPLATOS



MESA CARBONERA PIRA 70



MESA CARBONERA PIRA 70 SILVER

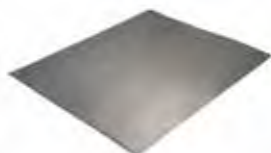

LÁMINAS PARA PIZZAS 70



PINZAS PARA CARNE TOP 400 MM



## ACCESORIOS INCLUIDOS

REF.	DESCRIPCIÓN
950.005	Pinzas para carne 330 mm
950.001	Atizador
900.048	Parrilla varilla 70 XL (585x535)
902.945	Mesa Frontal Inox 29 cm 70/70xl ED



PARRILLA VARILLA



PINZAS PARA CARNE 330 mm



ATIZADOR



MESA FRONTAL INOX 29 CM 70/70xl ED



La integración de la brasa PIRA para obtener todo el sabor #Piraflavour en la cocina es una apuesta de Xito.

## ACCESORIOS

REF.	DESCRIPCIÓN
750.001	Aro acoplador
750.002	Regulador de tiro externo
750.003	Cortallamas externo*
750.004	Sombrero Inox
750.005	Adaptador

\*Kit Chimenea con Cortallamas externo obligatorio. Info pag 42/43

901.048	Parrilla acanalada 70 XL (515x540)
960.048	Plancha 70 XL (525x540)
965.077	Soporte pinchos 70 XL (capacidad 8 u.)
961.048	Lámina para Pizzas 70 XL (570x500)
955.080	Pinchos 70xl/80
950.004	Pinzas para carne TOP 400 mm
920.048	Bandeja Calientaplatos 70 XL
924.048	Bandeja Calientaplatos 70 XL ED
904.045	Mesa Frontal 40 cm 70/70xl ED
770.248	Mesa Carbonera Pira 70 XL
770.348	Mesa Carbonera Pira 70 XL SILVER



PARRILLA ACANALADA



PLANCHA



SOPORTE PINCHOS

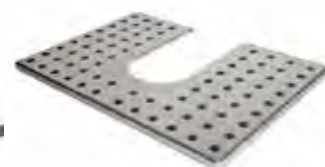

BANDEJA CALIENTAPLATOS



MESA CARBONERA  
PIRA 70 XL



MESA CARBONERA  
PIRA 70 XL SILVER

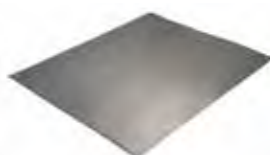

LÁMINAS PARA PIZZAS 70 XL



PINZAS PARA CARNE TOP 400 MM

REF.	DESCRIPCIÓN
950.005	Pinzas para carne 330 mm
950.001	Atizador
900.049	Parrilla varilla 80 (685x535)
902.949	Mesa Frontal Inox 29 cm 80 ED



PINZAS PARA CARNE 330 mm



ATIZADOR



PARRILLA VARILLA



MESA FRONTAL INOX 29 CM



Jordi Limon, "El fermentista", Pira assessor chef, y Chef propietario del restaurante Somorrostro en Barcelona.

ACCESORIOS

REF.	DESCRIPCIÓN
750.001	Aro acoplador
750.002	Regulador de tiro externo
750.003	Cortallamas externo*
750.004	Sombrero Inox
750.005	Adaptador
*Kit Chimenea con Cortallamas externo obligatorio. Info pag 42/43	
901.049	Parrilla acanalada 80 (615x540)
960.049	Plancha 80 (625x545)
965.080	Soporte pinchos 80 (capacidad 9 u.)
961.080	Lámina para Pizzas 80 (660x590)
970.049	Separador 80 4 guias
970.249	Separador 80 7 guias
900.492	1/2 Parrilla varilla 80 (330x545)
901.492	1/2 Parrilla acanalada 80 (230x540)
960.492	1/2 Plancha 80 (230x545)
955.080	Pinchos 70x1/80
950.004	Pinzas para carne TOP 400 mm
920.049	Bandeja Calientaplatos 80
924.049	Bandeja Calientaplatos 80 ED
904.049	Mesa Frontal 40 cm 80 ED
770.249	Mesa Carbonera Pira 80
770.349	Mesa Carbonera Pira 80 SILVER



PARRILLA ACANALADA



PLANCHA



SOPORTE PINCHOS

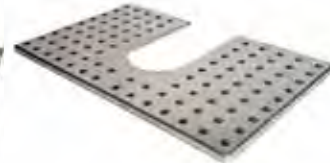

SOPORTE PINCHOS POLLO



PINZAS PARA CARNE TOP 400 MM



SEPARADOR 80 (4 GUIAS)



MESA CARBONERA PIRA 80



MESA CARBONERA PIRA 80 SILVER

## ACCESORIOS INCLUIDOS

REF.	DESCRIPCIÓN
950.005	Pinzas para carne 330 mm
950.001	Atizador
900.050	Parrilla varilla 90 (780x625)
904.050	Mesa Frontal Inox 40 cm 90 ED



PINZAS PARA CARNE 330 mm



ATIZADOR



PARRILLA VARILLA

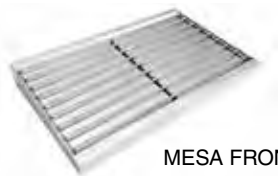

MESA FRONTAL INOX 40 CM



Chef Rakel Cernicharo, en Restaurante Karak, con los chefs Richard Alcayde y Jordi Bataller, ambos Pira chef assessors by la Cocina Gastrolab (Málaga)

## ACCESORIOS

REF.	DESCRIPCIÓN
750.001	Aro acoplador
750.002	Regulador de tiro externo
750.003	Cortallamas externo*
750.004	Sombrero Inox
750.005	Adaptador
*Kit Chimenea con Cortallamas externo obligatorio. Info pag 42/43	
901.050	Parrilla acanalada 90 (780x625)
960.050	Plancha 90 (700x585)
965.090	Soporte pinchos 90 (capacidad 11 u.)
965.020	Soporte pinchos Pollo 90 (capacidad 4 u.)
961.090	1/2 Lámina para Pizzas 90 (370x590)
970.050	Separador 90 4 guías
970.052	Separador 90 7 guías
900.052	1/2 Parrilla varilla 90 (385x625)
901.052	1/2 Parrilla acanalada 90 (300x585)
960.052	1/2 Plancha 90 (325x587)
965.092	1/2 Soporte pinchos 90 (capacidad 4u.)
955.090	Pinchos 90/120
955.120	Pinchos Pollo 90/120
950.004	Pinzas para carne TOP 400 mm
920.050	Bandeja Calientaplatos 90
924.050	Bandeja Calientaplatos 90 ED
902.950	Mesa Frontal 29 cm 90 ED
770.250	Mesa Carbonera Pira 90
770.350	Mesa Carbonera Pira 90 SILVER

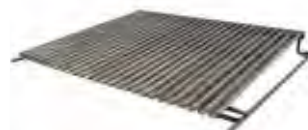

PARRILLA ACANALADA



PLANCHA



SOPORTE PINCHOS



SOPORTE PINCHOS POLLO

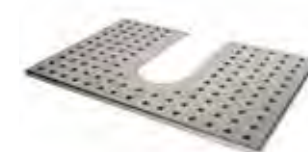

BANDEJA CALIENTAPLATOS



SEPARADOR 90 (4 GUIAS)



MESA CARBONERA PIRA 90



MESA CARBONERA PIRA 90 SILVER



PINZAS PARA CARNE TOP 400 MM

## ACCESORIOS INCLUIDOS

REF.	DESCRIPCIÓN
950.005	Pinzas para carne TOP 400 mm
950.001	Atizador
900.050	Parrilla varilla 90 (780x625)
904.150	Mesa Frontal Inox 18 cm 90 ED



PARRILLA VARILLA



PINZAS PARA CARNE TOP 4000



ATIZADOR



MESA FRONTAL INOX 40 CM



Detalle Pinchos Pollo para Horno 90D SD/ED en restaurante Tramvai a Crema

## ACCESORIOS

REF.	DESCRIPCIÓN
759.007	Cortallamas Externo* 90
759.008	Sombrero Inox 90
*Kit Chimenea con Cortallamas externo obligatorio. Info pag 42/43	
901.050	Parrilla acanalada 90 (780x625)
960.050	Plancha 90 (700x585)
965.090	Soporte pinchos 90 (capacidad 11 u.)
965.020	Soporte pinchos Pollo 90 (capacidad 4 u.)
961.090	1/2 Lámina para Pizzas 90 (370x590)
970.050	Separador 90 4 guías
970.052	Separador 90 7 guías
900.052	1/2 Parrilla varilla 90 (385x625)
901.052	1/2 Parrilla acanalada 90 (300x585)
960.052	1/2 Plancha 90 (325x587)
965.092	1/2 Soporte pinchos 90 (capacidad 4u.)
955.090	Pinchos 90/120
955.120	Pinchos Pollo 90/120
950.004	Pinzas para carne 330 mm
924.050	Bandeja Calientaplatos 90 ED

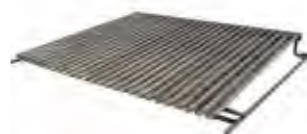

PARRILLA ACANALADA



PLANCHA



SOPORTE PINCHOS



SOPORTE PINCHOS POLLO



BANDEJA CALIENTAPLATOS



SEPARADOR 90 (4 GUIAS)



1/2 PARRILLA VARILLA

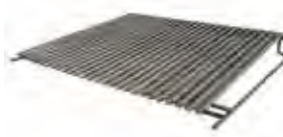

1/2 PARRILLA ACANALADA



1/2 LÁMINA PARA PIZZAS 90



PINZAS PARA CARNE 300 MM

## ACCESORIOS INCLUIDOS

REF.	DESCRIPCIÓN
950.005	Pinzas para carne 330 mm
950.008	Atizador
900.120	Parrilla varilla 120 (1060x625)
904.012	Mesa Frontal Inox 40 cm 120 ED



PARRILLA VARILLA



PINZAS PARA CARNE 330 mm



ATIZADOR



MESA FRONTAL INOX 40 CM



Chef Jordi Limón, "El Fermentista" durante un showcooking en nuestra aula de formación.

## ACCESORIOS

REF.	DESCRIPCIÓN
750.007	Cortallamas Externo* 120
750.008	Sombrero Inox 120
*Kit Chimenea con Cortallamas externo obligatorio. Info pag 42/43	
901.120	Parrilla acanalada 120 (990x625)
965.120	Soporte pinchos 120 (capacidad 15 u.)
965.021	Soporte pinchos Pollo 120 (capacidad 5 u.)
961.120	1/2 Lámina para Pizzas 120 (520x590)
970.120	Separador 120 4 guías
970.122	Separador 120 6 guías
900.122	1/2 Parrilla varilla 120 (535x625)
901.122	1/2 Parrilla acanalada 120 (460x585)
960.122	1/2 Plancha 120 (458x590)
965.122	1/2 Soporte pinchos 120 (capacidad 6u.)
955.090	Pinchos 90/120
955.120	Pinchos Pollo 90/120
950.004	Pinzas para carne TOP 400 mm
920.120	Bandeja Calientaplatos 120
924.120	Bandeja Calientaplatos 120 ED
902.912	Mesa Frontal 29 cm 120 ED
770.220	Mesa Carbonera Pira 120
770.320	Mesa Carbonera Pira 120 SILVER



PARRILLA ACANALADA



1/2 PLANCHA



SOPORTE PINCHOS



SOPORTE PINCHOS POLLO



BANDEJA CALIENTAPLATOS



SEPARADOR 120 (4 GUIAS)

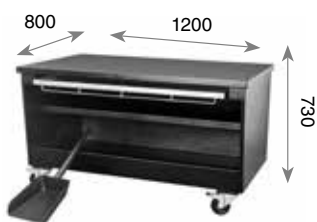

MESA CARBONERA PIRA 120



MESA CARBONERA PIRA 120 SILVER



PINZAS PARA CARNE TOP 400 MM

## ACCESORIOS INCLUIDOS

REF.	DESCRIPCIÓN
950.005	Pinzas para carne 330 mm
950.008	Atizador
900.120	Parrilla varilla 120 (1060x625)



PARRILLA VARILLA



PINZAS PARA CARNE 330 mm



ATIZADOR



MESA FRONTAL INOX 40 CM



## ACCESORIOS

REF.	DESCRIPCIÓN
750.007	Cortallamas Externo* 120
750.008	Sombrero Inox 120
*Kit Chimenea con Cortallamas externo obligatorio. Info pag 42/43	
901.120	Parrilla acanalada 120 (990x625)
965.120	Soporte pinchos 120 (capacidad 15 u.)
965.021	Soporte pinchos Pollo 120 (capacidad 5 u.)
961.120	1/2 Lámina para Pizzas 120 (520x590)
970.120	Separador 120 4 guías
970.122	Separador 120 6 guías
900.122	1/2 Parrilla varilla 120 (535x625)
901.122	1/2 Parrilla acanalada 120 (460x585)
960.122	1/2 Plancha 120 (458x590)
965.122	1/2 Soporte pinchos 120 (capacidad 6u.)
955.090	Pinchos 90/120
955.120	Pinchos Pollo 90/120
950.004	Pinzas para carne TOP 400 mm
924.120	Bandeja Calientaplatos 120 ED



PARRILLA ACANALADA



1/2 PLANCHA



SOPORTE PINCHOS POLLO



SOPORTE PINCHOS



PINCHOS POLLO



PINCHOS

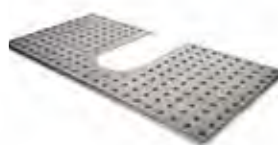

BANDEJA CALIENTAPLATOS



SEPARADOR 120 (4 GUIAS)



PINZAS PARA CARNE TOP 400 MM



**HORNOS DE BRASA  
SERIE BLACK**

**PIRA 70 BLACK**

REF.	450.101
PRECIO	4.150 €

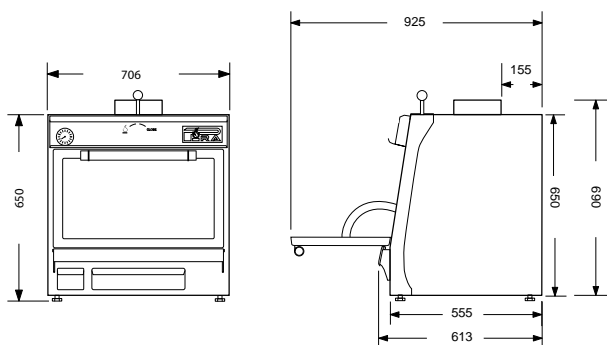

**ACCESORIOS**

REF.	DESCRIPCIÓN
901.045	Parrilla acanalada 70 (515x470)
960.045	Plancha 70 (525x470)
965.070	Soporte pinchos 70 (capacidad 8 u.)
961.070	Lámina para Pizzas 70 (570x430)
955.070	Pinchos 70
950.004	Pinzas para carne TOP 400 mm
920.045	Bandeja Calientaplatos 70
770.245	Mesa Carbonera Pira 70
770.345	Mesa Carbonera Pira 70 SILVER

**PIRA 80 BLACK**

REF.	490.101
PRECIO	5.150 €

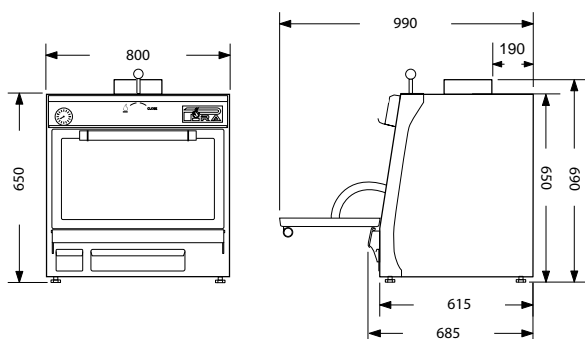

**ACCESORIOS**

REF.	DESCRIPCIÓN
901.049	Parrilla acanalada 80 (615x540)
960.049	Plancha 80 (625x545)
965.080	Soporte pinchos 80 (capacidad 9 u.)
961.080	Lámina para Pizzas 80 (660x500)
970.049	Separador 80 4 guías
970.249	Separador 80 7 guías
900.492	1/2 Parrilla varilla 80 (330x545)
901.492	1/2 Parrilla acanalada 80 (230x540)
960.492	1/2 Plancha 80 (230x545)
955.080	Pinchos 70x1/80
950.004	Pinzas para carne TOP 400 mm
920.049	Bandeja Calientaplatos 80
770.249	Mesa Carbonera Pira 80
770.349	Mesa Carbonera Pira 80 SILVER



MESA CARBONERA LUX



BANDEJA CALIENTAPLATOS

**PIRA 90 BLACK**

REF.	500.101
PRECIO	5.725 €

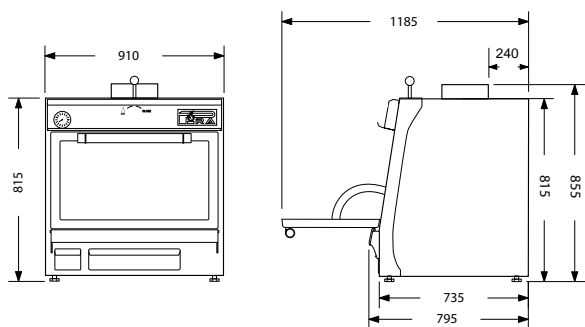

**ACCESORIOS**

REF.	DESCRIPCIÓN
901.050	Parrilla acanalada 90 (780x625)
960.050	Plancha 90 (700x585)
965.090	Soporte pinchos 90 (capacidad 11 u.)
965.020	Soporte pinchos Pollo 90 (capacidad 4 u.)
961.090	1/2 Lámina para Pizzas 90 (370x590)
970.050	Separador 90 4 guías
970.052	Separador 90 7 guías
900.052	1/2 Parrilla varilla 90 (385x625)
901.052	1/2 Parrilla acanalada 90 (300x585)
960.052	1/2 Plancha 90 (325x587)
965.092	1/2 Soporte pinchos 90 (capacidad 4u.)
955.090	Pinchos 90/120
955.120	Pinchos Pollo 90/120
950.004	Pinzas para carne TOP 400 mm
924.050	Bandeja Calientaplatos 90
770.250	Mesa Carbonera Pira 90
770.350	Mesa Carbonera Pira 90 SILVER



PARRILLA ACANALADA



1/2 PLANCHA



# PIRA

## KIT Chimenea

Los hornos PIRA están dotados de cortallamas y regulador de tiro integrado, preparados para funcionar desde el primer momento simplemente situándolos bajo una campana. El diámetro de la salida de humos es de 180 o 210 mm, dependiendo del modelo.

Si desea instalar un horno PIRA en una cocina junto a los otros elementos de cocción, aunque nuestro horno ya dispone de cortafuegos y regulador de salida de aire incorporados, recomendamos instalar el horno con el cortafuegos externo y el sombrero como mínimo.

El cortafuegos externo garantiza al igual que el interno, que no haya llamas o chispas que puedan salir por la salida de humos, pero al ser visible a simple vista, a diferencia del cortallamas interno, no existe la posibilidad de encender el horno sin percatarse de su ausencia.

En atención a la legislación existente en ciertos países, existe también la posibilidad de adquirir estos accesorios como elementos externos al horno. Las normativas en la mayoría de países indican que tiene que haber una salida de humos independiente para los humos provenientes de combustibles sólidos (leñas o carbones) y en algunos casos se exige que el cortallamas sea visible a simple vista, por lo que siempre habrá que observar la legislación aplicable. Así teniendo en cuenta la legislación y las necesidades del cliente, el kit chimenea se puede adaptar a todas las necesidades.

Para una mayor eficiencia en el tiro, todos los hornos PIRA deben ser instalados bajo una campana extractora, permitiendo dos posibilidades:

- Instalación con tiro directo desde la salida de humos del horno hacia el exterior, prescindiendo totalmente de los accesorios del kit chimenea. A pesar de ello, necesitaremos utilizar una campana extractora para una evacuación eficiente de los humos de cocción que saldrán del horno al abrir la puerta.

- Instalar el kit chimenea en una de sus múltiples versiones, esta es la opción más habitual escogida entre los profesionales.

El Kit chimenea se encuentra en dos versiones, Kit chimenea con cortallamas no desmontable y Kit chimenea con cortallamas desmontable.



## Kit Chimenea con cortallamas no desmontable

Kit disponible en los modelos 50, 70, 70xl, 80, 90, 90D.  
Se puede elegir con o sin regulador externo, siempre teniendo en cuenta la normativa, los componentes que lo forman son:

### Sombrero:

Disminuye ligeramente la temperatura del humo, asegurando un mejor tiro y suplementa la seguridad del cortafuegos interior evitando que entre nada por la chimenea al horno.

### Cortallamas Externo:

Al igual que el cortallamas interior, evita que salga ninguna chispa o llama al exterior. Importante, nunca lavar bajo el agua.

### Regulador Externo:

Regula la salida de humos con un dispositivo externo, además su forma de tubo también garantiza un mejor tiraje.

### Aro acoplador:

Pieza necesaria para encajar el Cortafuegos Externo sin el Regulador Externo.

### Adaptador:

Reducción de la salida de humos y aire caliente del horno, de 180 mm a 150 mm.



Kit Chimenea con cortallamas no desmontable y regulador externo.



Kit Chimenea con cortallamas no desmontable.

## Kit Chimenea con cortallamas desmontable

Para los hornos PIRA 120 la única posibilidad de kit chimenea es de CORTAFUEGOS 120 + SOMBRERO 120. Este revolucionario kit es desmontable y permite al usuario lavarlo con agua, sin miedo a obstruir el paso del aire en el cortallamas.

Es habitual que en los cortallamas no desmontables, que se tienen que limpiar a base de golpes, algun usuario lo ponga debajo del agua para limpiar y entonces con restos de hollin mas restos de agua se forma una mezcla pastosa parecido al cemento que inutiliza el cortallamas externo.

También tenemos la opción de KIT cortallamas desmontables para el resto de modelos, y además en una segunda versión más corta.

Este KIT, tambien tiene la posibilidad de ofrecer un sombrero totalmente ciego.



Kit Chimenea desmontable.



Kit Chimenea corto con cortallamas desmontable.



Kit Chimenea corto ciego con cortallamas desmontable.