



Magefesa[®]

Instructivo y Garantía



**Olla a presión
rápida**

CHEF

IMPORTANTES MEDIDAS DE SEGURIDAD

ATENCIÓN: Lea atentamente este instructivo-garantía antes de usar esta olla a presión. Guárdelo junto con el justificante de compra y, a ser posible con el embalaje original.

NORMAS BÁSICAS DE SEGURIDAD

Para reducir los riesgos de daños personales, se deben seguir unas normas básicas de seguridad, tales como:

1. Lea cuidadosamente las instrucciones. Un uso inapropiado de la olla a presión puede producir grandes daños a las personas o a las cosas.
2. Asegúrese que se encuentra bien cerrada antes de poner la olla en funcionamiento.
3. Nunca utilice la olla a presión sin agua. Puede causar un serio peligro.
4. Use siempre fuentes de calor compatibles con la olla (ver instrucciones).
5. La olla a presión nunca debe ser usada por niños, siendo necesaria una supervisión adecuada cuando la olla a presión se use cerca de ellos.
6. No utilice la olla a presión para otro uso que no sea la cocción de alimentos en el hogar.
7. Tiene que tener extrema precaución en el uso de la olla a presión cuando contiene líquidos calientes. No toque las superficies calientes. Use guantes o manoplas.
8. Cuando la olla esté en funcionamiento, nunca se debe colocar encima de la válvula (7) ningún sobrepeso ni usar otra pieza que lo sustituya.
9. Nunca abra la olla hasta que la presión interna haya sido completamente eliminada. Compruebe previamente que no sale vapor cuando se le quita la válvula giratoria (7).
10. Utilice siempre recambios originales para la junta / empaque, válvulas, tornillos, mangos y asas.
11. Cuando la olla esté en funcionamiento, no debe ser golpeada ni zarandeada para evitar deformaciones en el cuerpo de la olla y de la tapa que pueden producir escapes de vapor.
12. Nunca debe sustituirse la junta / empaque de silicona por una anilla de metal para aumentar el sellado.
13. Ante cualquier problema, lleve la olla a presión al *Servicio Técnico Autorizado* más próximo.

GUARDE ESTAS INSTRUCCIONES PARA FUTURAS CONSULTAS

DESCRIPCIÓN DE LA OLLA CHEF

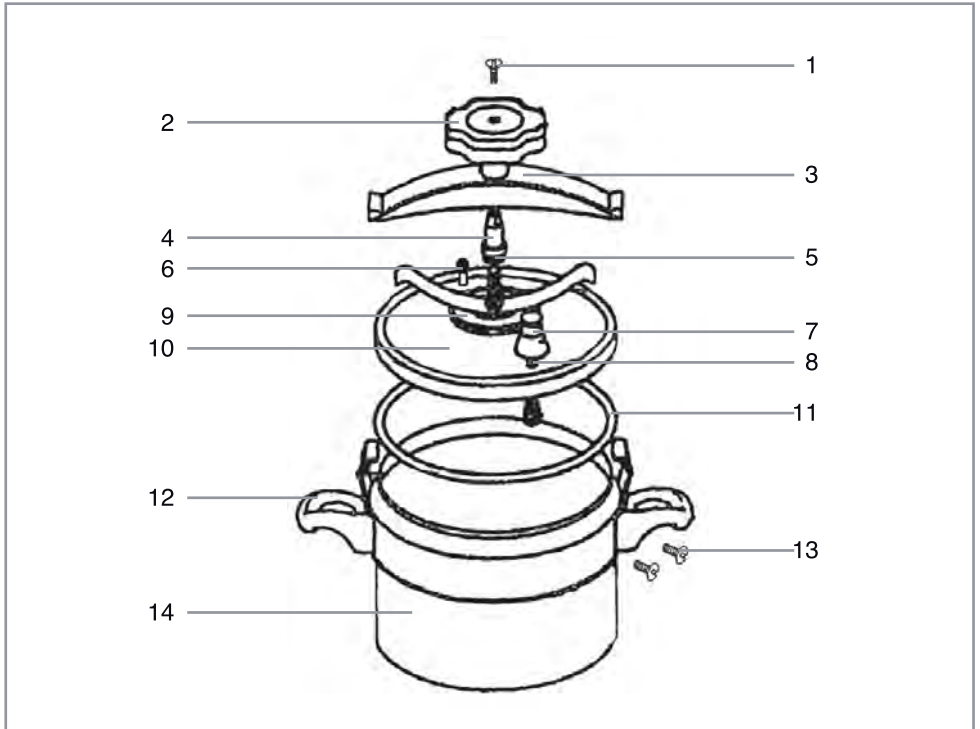

PARTES DE LA OLLA

- | | |
|------------------------------|--------------------------------|
| 1. Tornillo del pomo. | 8. Chimenea. |
| 2. Pomo de baquelita. | 9. Disco refuerzo. |
| 3. Puente de acero inox. | 10. Tapa (sin accesorios). |
| 4. Tuerca de fijación. | 11. Junta de silicona. |
| 5. Tornillo central. | 12. Asa de baquelita. |
| 6. Válvula de seguridad. | 13. Tornillo de fijación asas. |
| 7. Válvula giratoria (pesa). | 14. Cuerpo de la olla. |

VENTAJAS DE LA OLLA A PRESIÓN CHEF

● Rapidez y economía.

Cocinará hasta 3 veces más rápido que de la forma tradicional.

● Seguridad.

La Olla a Presión *CHEF* dispone de 3 sistemas de seguridad.

1. *Válvula de giratoria o pesa (7)*: mantiene la presión de la olla dejando salir el vapor sobrante.
2. *Válvula de seguridad (6)*: Si por alguna circunstancia, la chimenea (8) se obstruye y se produce un aumento de la presión en la olla, entra en funcionamiento esta válvula de seguridad dejando salir el vapor y equilibrando la sobre presión. Si esto ocurriese, deberá retirar la olla de la fuente de calor, esperar a que la olla pierda la presión para abrirla y proceder a la limpieza de la chimenea con abundante agua y jabón.
3. *Puente de acero inoxidable (3)*: Si por alguna razón, se obstruyen o no funcionan los dos dispositivos de seguridad anteriores, este puente de acero inoxidable, actúa como ballesta permitiendo el escape de vapor entre el cuerpo de la olla y la tapa, evitando que ésta alcance presiones no deseadas. Si esto ocurriese, deberá revisar tanto la chimenea como la válvula de seguridad, limpiando ambas con abundante agua y jabón. Si persiste, deberá llevar la olla al Servicio Técnico Autorizado más cercano.

● Salud:

Cocinando con esta olla a presión, se preserva un mayor porcentaje de minerales (Mg, Fe, Ca, etc.) y vitaminas (A y C) que en la cocina tradicional.

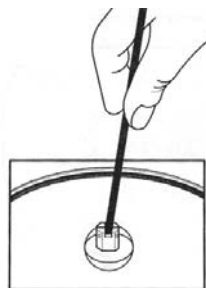

FIG.1

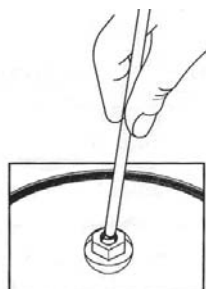

FIG.2

ANTES DE CADA USO

CHIMENEA

1. Tome la tapa de la olla (10) sin colocar la pesa (7) en la chimenea (8).
2. Compruebe mirando al trasluz que la chimenea esté limpia de cualquier resto que pudiera obstruir la salida del vapor. En caso contrario, use una varilla para su limpieza (FIG. 1 - vea página 3).

VÁLVULA DE SEGURIDAD

1. Compruebe el correcto funcionamiento de la válvula de seguridad (6) presionando en el detector de presión con una varilla desde el interior de la tapa. Si el detector cede, es correcto (FIG. 2).
2. En caso contrario deberá desmontar la válvula y limpiarla con abundante agua y jabón.
3. Si el problema persiste, deberá dirigirse al *Servicio Técnico Autorizado* más próximo.

LLENADO DE LA OLLA A PRESIÓN

1. Nunca llene la olla más de dos tercios (2/3) de su capacidad, incluyendo tanto la comida como el líquido añadido. (FIG. A1)
2. Cuando cocine alimentos que aumenten su tamaño durante la cocción como el arroz, cereales o legumbres, no llene la olla por encima de 1/2 de su capacidad. (FIG. A2)
Si llena la unidad por encima de su capacidad, los sistemas de seguridad podrían sufrir daños, aumentando el riesgo de quemaduras.
3. Añada SIEMPRE líquido a la olla. Si utiliza la olla para cocinar alimentos, excepto los cocinados al vapor, utilice entre 1,5 y 2 litros de líquido. (FIG. A3)
De este modo evitará posibles quemaduras y que los alimentos se peguen. Recuerde que si utiliza menos líquido de la cantidad recomendada, provocará daños en su olla a presión y se sobrecalentará.
4. Tenga en cuenta que ciertos alimentos como la cebada, fruta y pasta pueden producir espuma y bloquear los sistemas de liberación de presión (válvula giratoria y de seguridad). Estos alimentos no deberían cocinarse en la olla a presión.
5. Para prevenir daños en el aluminio es importante añadir la sal una vez que el contenido de la olla comience a hervir, esto ayudará a que se disuelva completamente. Una vez transcurrido el tiempo de cocción, evite que los alimentos permanezcan en la olla por mucho tiempo ya que los componentes ácidos de los alimentos y la sal pueden causar corrosión si están en contacto con el aluminio durante un periodo prolongado de tiempo.

LLENADO MÁXIMO

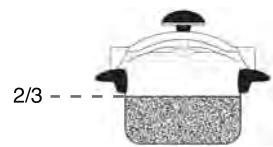

FIG.A1

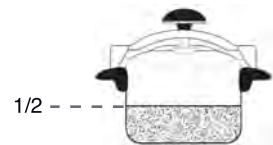

FIG.A2

LLENADO MÍNIMO

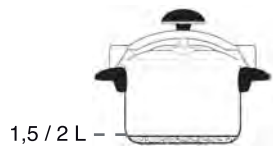

FIG.A3

ATENCIÓN: NO UTILICE NUNCA LA OLLA PARA FREÍR CON ACEITE BAJO PRESIÓN. SIEMPRE DEBE TENER COMO MÍNIMO 1/4 DE LITRO DE AGUA.

ATENCIÓN: SI LA OLLA A PRESIÓN SE HA CALENTADO SIN LÍQUIDO EN SU INTERIOR, DEBE SER LLEVADA AL *SERVICIO TÉCNICO AUTORIZADO* MÁS PRÓXIMO ANTES DE CUALQUIER USO.

ATENCIÓN: NUNCA META O USE LA OLLA A PRESIÓN DENTRO DE UN HORNO ENCENDIDO.

FUENTES DE CALOR APTAS PARA LA OLLA A PRESIÓN CHEF: LAS OLLAS A PRESIÓN CHEF, ESTÁN FABRICADAS EN ALUMINIO EXTRAFUERTE. ÚNICAMENTE PUEDEN SER USADAS EN COCINAS (ESTUFAS) QUE UTILICEN EL GAS COMO FUENTE DE CALOR.

CÓMO CERRAR LA OLLA A PRESIÓN

1. Gire el pomo (2) en el sentido contrario a las agujas del reloj, hasta que el puente (3) de acero inoxidable descansa sobre la tapa (FIG. 1).
2. Deslice la tapa horizontalmente sobre el cuerpo asegurándose que la misma queda bien encajada en los bordes de éste, y que los extremos del puente coinciden con los orejones (FIG. 2).
3. Gire el pomo (2) en el sentido de las agujas del reloj hasta que el puente de acero (3) contacte con los orejones. A partir de aquí siga girando el pomo entre 1 y 1/2 y 3 vueltas hasta que la olla quede bien cerrada (FIG. 3).
4. Coloque la pesa (7) sobre la chimenea (8) (FIG. 4).



FIG.1

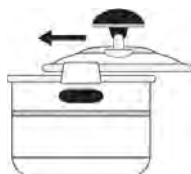

FIG.2



FIG.3



FIG.4

COCCIÓN EN LA OLLA A PRESIÓN CHEF

1. Colocados los alimentos a cocinar y cerrada la olla, ponga la pesa (7) en la chimenea (8) y coloque la olla a presión sobre la fuente de calor, en su máxima intensidad.
2. Al cabo de un tiempo, la pesa (7) empezará a soltar presión y a girar. La olla ha alcanzado su presión de funcionamiento. En este momento, debe bajar la intensidad de la fuente de calor a un nivel que permita una pequeña salida de vapor.
3. A partir de este punto es cuando deben contarse los tiempos de cocción de los alimentos. *(Vea la tabla orientativa de tiempos de cocción).*
4. Durante la cocción es normal observar pequeñas pérdidas de vapor por la válvula de seguridad (6).
5. Verifique siempre que la olla esté correctamente centrada en el quemador y que la llama de gas no sobresale del fondo de la olla. De esta forma ahorrará energía y evitará que la llama deteriore las asas (12) de la olla a presión, así como la junta / empaque de silicona.

FIN DE LA COCCIÓN. APERTURA DE LA OLLA A PRESIÓN

1. Una vez terminada la cocción, debe retirar la olla de la fuente de calor y dejar que baje la presión de forma natural hasta que la olla quede sin ella. Quite la pesa (7) y si queda algo de vapor en la olla, éste saldrá por la chimenea (8) (FIG. 5a).
2. Si quiere acelerar el proceso de apertura de la olla a presión, puede colocarla debajo del grifo dejando caer un pequeño chorro de agua fría sobre la tapa. Ahora puede retirar la pesa de la chimenea para que salga el resto del vapor y proceder a la apertura de la olla (FIG. 6a, 6b y 6c. *Página 7*).
3. Para abrir la olla, una vez retirada la pesa (7), gire el pomo (2) en sentido contrario a las agujas del reloj, hasta que el puente de acero inoxidable (3) descance sobre la tapa. Ahora puede separar la tapa del cuerpo deslizándola horizontalmente (FIG. 5c y 5c).



FIG.5a

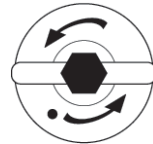

FIG.5b

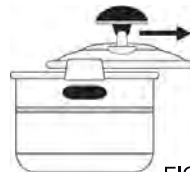

FIG.5c

**NUNCA DEBE SUMERGIR LA OLLA A PRESIÓN EN AGUA.
NUNCA FUERCE LA TAPA DE LA OLLA A PRESIÓN PARA ABRIRLA.**



FIG.6a

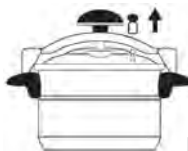

FIG.6b

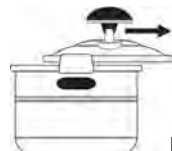

FIG.6c

RECOMENDACIONES PARA EL PRIMER USO DE LA OLLA

1. Llene la olla hasta los 2/3 de su capacidad con agua añadiendo una cucharada de bicarbonato sódico de uso alimentario.
2. Cierre la olla y póngala al fuego, haciéndola funcionar 15 minutos a contar desde que alcanza su presión de trabajo.
3. Al término de este tiempo, coloque la olla debajo del grifo dejando caer un pequeño chorro de agua fría sobre la tapa (10) hasta que baje la presión. Ahora puede retirar la válvula giratoria (7) de la chimenea (8) para que salga el resto del vapor y proceder a la apertura de la olla.
4. Abra la olla y lávela con abundante agua tibia y un jabón neutro para vajilla.

CONSEJOS PRÁCTICOS PARA EL USO DE LA OLLA

1. Ahorrará energía si, una vez apagado el fuego, mantiene la olla trabajando aprovechando el calor residual de la fuente de calor y terminando la cocción de los alimentos con dicho calor.
2. Si sale mucho vapor por la tapa (10) es síntoma de que la olla está mal cerrada. Las causas pueden ser varias:
 - Compruebe que la tapa (10) esté bien acoplada en el cuerpo de la olla (14).
 - Es posible que no haya apretado el pomo lo suficiente.
 - La olla ha llegado a su presión de trabajo. En este caso, la junta / empaque de silicona (11) puede estar mal colocada o estar gastada, en cuyo caso deberá reemplazarla.
3. Si ha cocinado un alimento pastoso, agite ligeramente la olla antes de proceder a su apertura. De esta forma evitará posibles salpicaduras.
4. Si los alimentos no se han cocinado en el tiempo previsto, o si se han quemado, debe revisar la intensidad de la fuente de calor, la cantidad de líquido que agregó o si la válvula giratoria (7) ha sido colocada correctamente.
5. Una vez haya finalizado la cocción de los alimentos, debe sacarlos de la olla, pues si los deja en ella durante un tiempo, los ácidos de estos alimentos podrían dañar el cuerpo de ésta.
6. Si se le han quemado los alimentos dentro de la olla a presión, debe dejarlos a remojo un tiempo con agua templada y luego limpiarla de la forma que se indica a continuación.

ATENCIÓN: NUNCA DEJE DESATENDIDA LA OLLA A PRESIÓN MIENTRAS ESTÉ COCINANDO

MANTENIMIENTO Y LIMPIEZA DE LA OLLA

Para mantener su olla en perfecto estado de uso y conservación, le recomendamos lavarla después de cada uso con agua tibia, jabón para vajilla y una esponja o estropajo suave, siguiendo las siguientes instrucciones (*FIG. 7a y 7b*).

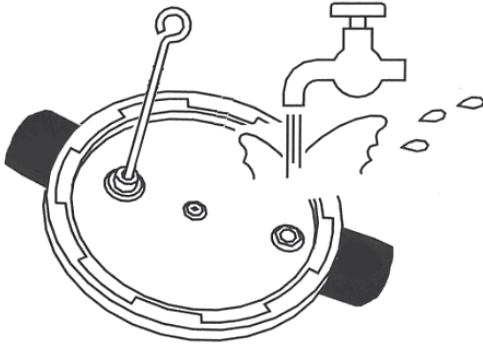

FIG.7a

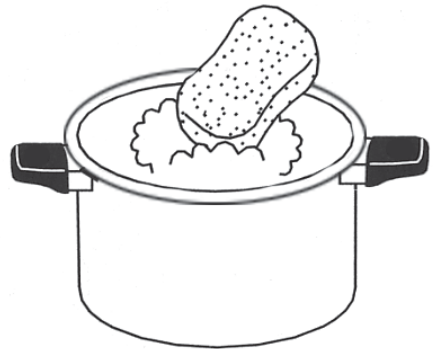

FIG.7b

TAPA

Al tiempo que aplica un fuerte chorro de agua tibia, debe limpiar el orificio de la chimenea (8) con una varilla y la válvula de seguridad (6) presionando el bulón con la varilla (FIG.7a).

CUERPO

1. Dependiendo de los alimentos y condimentos utilizados para cocinar, así como del contenido mineral del agua usada en la cocción, podrían aparecer manchas e incluso llegar a oscurecerse el fondo de la olla. Esto no afectará a sus alimentos ni al funcionamiento de la olla a presión. Para su limpieza puede hervir en la olla durante 10 minutos una solución de agua y una cuarta parte de vinagre o jugo de limón y luego proceder a la limpieza con un jabón neutro y un estropajo, aclarando con abundante agua.
2. Nunca deje en el interior del cuerpo de la olla lejía (ni siquiera diluida), salsa de tomate, agua salada ni ningún otro ácido, pues éste puede producir corrosión.

JUNTA / EMPAQUE DE SILICONA

1. La junta / empaque es de silicona de larga duración. Debe lavarla con agua y jabón neutro después de cada uso, junto con la tapa y sin sacarla de su ubicación.
2. Cuando la olla vaya a ser guardada, coloque la tapa invertida sobre el cuerpo. De esta forma permitirá la circulación del aire y evitará los malos olores así como la deformación de la junta / empaque.

ATENCIÓN: LA JUNTA DE SILICONA SE CONSIDERA GASTADA CUANDO, DEBIDO AL USO, LA OLLA EMPIEZA A PERDER VAPOR POR ELLA Y NO MANTIENE LA SUFICIENTE PRESIÓN; EN CUALQUIER CASO, LA JUNTA DEBE SER REEMPLAZADA AL MENOS CADA DOS AÑOS.

ATENCIÓN: UTILICE SIEMPRE RECAMBIOS ORIGINALES PARA ASEGURAR EL CORRECTO FUNCIONAMIENTO DE LA OLLA.

ATENCIÓN: NO DEBE LAVAR NI EL CUERPO NI LA TAPA DE LA OLLA EN EL LAVAVAJILLAS.

ATENCIÓN: NUNCA USE ESTROPAJOS DE ACERO PUES PUEDEN RAYAR EL INTERIOR DE SU OLLA.

ATENCIÓN: ANTES DE USAR LA OLLA, COMPRUEBE QUE LAS TUERCAS DEL CONO CENTRAL, DE LA CHIMENEA Y DE LA VÁLVULA DE SEGURIDAD ESTÁN PERFECTAMENTE APRETADAS EN SU LUGAR CORRESPONDIENTE.



Magefesa[®]

Instructivo y garantía

**Instruction Manual
& Warranty**



**Olla a presión
rápida**

**Fast pressure
cooker**

CHEF

CONTENTS

	PAGE
1. INTRODUCTION.	2
2. ADVANTAGES OF YOUR PRESSURE COOKER .	2
3. ENVIROMENTAL SAFETY AND RECYCLING STANDARDS.	2
4. IMPORTANT SAFETY INFORMATION.	3
5. GENERAL PRODUCT DESCRIPTION.	4
6. MAIN COMPONENTS AND SAFETY FEATURES.	5
7. DIRECTIONS FOR PROPER USE.	6
8. USING THE COOKER FOR THE FIRST TIME.	6
9. FILLING THE PRESSURE COOKER.	7
10. CHECKING THE VALVES.	8
11. SECURING THE PRESSURE COOKER LID.	8
12. COOKING UNDER PRESSURE.	9
13. PRESSURE RELEASE METHODS.	10
14. CLEANING AND CARE INSTRUCTIONS.	11
15. TECHNICAL SUPPORT AND REPLACEMENT PARTS.	14
16. PRACTICAL TIPS FOR PRESSURE COOKER USE.	15
17. COOKING TIMES CHART.	17
18. RECIPES.	20
19. REPLACEMENT PARTS CHART.	28



1. INTRODUCTION

Thank you for choosing the Magefesa pressure cooker. We appreciate the confidence you have placed in our company, allowing us to play an important role in your home cooking needs.

The Magefesa pressure cooker, designed and manufactured under the highest quality and safety standards, will provide you and your family with healthy and flavorful meals for years to come.

2. ADVANTAGES OF YOUR PRESSURE COOKER

Cooking with a Magefesa pressure cooker will change the way you prepare your meals, allowing you to cook your favorite dishes in a fraction of the time traditional cookware do.

As foods are cooked in shorter time, their natural colors and flavors are preserved. While traditional cooking involves boiling in an open pot, pressure cooking retains all water-soluble vitamins and minerals since no steam is released. Less liquid is required when cooking with a pressure cooker, allowing you to savor the natural juices of foods.

The Magefesa pressure cooker is one the safest in the market with 3 different safety devices. The Swivel Valve (22), Safety Valve (7), and Clamp bar (35) form core pressure release systems, leaving no room for worries during performance.

We invite you to experience efficient food preparation, practical cooking and appealing dishes through the use of your Magefesa pressure cooker, right in the comfort of your own kitchen.

3. ENVIROMENTAL SAFETY AND RECYCLING STANDARDS

Cookware, along with its accessories and packaging should be recycled in an environmentally friendly manner. Please comply with your local, regional or national regulations.

4. IMPORTANT SAFETY INFORMATION



ATTENTION: Read the instructions included in this manual prior to using your pressure cooker. Save purchase receipts and packaging materials for future reference.

SAFETY INSTRUCTIONS

1. Read all the instructions carefully.
2. Do not allow children near the area where the pressure cooker is being used.
3. Do not place the pressure cooker in a heated oven.
4. When under pressure, move the unit with extreme caution. Do not touch the hot surfaces. Use the handles. If necessary, wear oven gloves.
5. Do not use the pressure cooker for other than its intended purpose.
6. This appliance cooks under pressure. Improper use may result in scalding injury. Make sure the unit is properly closed before operating.
7. Never force the pressure cooker open. Do not open the cooker until making sure the internal pressure has been released completely.
8. Never use the cooker without water, as this would cause severe damage to the unit.
9. Do not fill the pressure cooker more than two thirds (2/3) full. When cooking foods that expand during cooking such as rice, pulses or stewed fruit do not fill the unit over one half (1/2) full.
10. Use the heat sources in accordance with their instructions for use.
11. Be aware that certain foods, such as apple sauce, cranberries, pearl barley, oatmeal or any other cereals, split peas, noodles, macaroni, rhubarb, or spaghetti can foam, froth, and sputter, and clog the pressure release devices. These foods should NOT be cooked in the pressure cooker.
12. When cooking meat with skin (i.e. tongue), that often swells at high temperatures, do not pierce the skin while swollen, as this may result in scalding injuries.
13. When cooking thick foods gently shake the pressure cooker before opening the lid to avoid splashing.
14. When regular operating pressure is reached, lower the heat to maintain the liquid inside the cooker and avoid evaporation. This will prevent the pressure cooker pot from boiling dry.
15. Always check the pressure release devices for clogging before each use.
16. Do not use this pressure cooker for pressure frying with oil.
17. Do not handle the security systems beyond what is stipulated in the maintenance instructions specified in this manual.
18. Only use genuine replacement parts in accordance with your pressure cooker model.
19. Keep these instructions in a safe place. Additional copies of the instruction manual may be downloaded from the MAGEFESA website at www.magefesausa.com

5. GENERAL PRODUCT DESCRIPTION



PARTS OF THE PRESSURE COOKER

- | | |
|-----------------------|---------------------|
| 1. Lid. | 23. Steam pipe. |
| 33. Triangular knob. | 8. Silicone gasket. |
| 22. Swivel valve. | 37. Side clamps. |
| 35. Clamp bar. | 9. Helper handles. |
| 36. Knob safety bolt. | 11. Body. |
| 7. Safety valve. | |

6. MAIN COMPONENTS AND SAFETY FEATURES

SAFETY FEATURES

Your pressure cooker has been designed with three different security devices. Please, become familiar with these important safety features and the way they function prior to use.

1. *Swivel valve (22):*

Maintains the operating pressure of the pressure cooker at all times, allowing the excess steam to exit.

2. *Safety valve (7):*

Comes into action when excessive pressure is generated inside the pressure cooker and/or the steam pipe (23) is obstructed. Should this occur, remove the pressure cooker from the heat source and clean it with a thin rod.

3. *Clamp bar (35):*

If both the above safety systems become obstructed, the clamp bar will allow the lid to open enough to release the accumulated pressure inside the cooker. Should this occur, take your pressure cooker to an Authorized Service Center for technical support. Do not use the unit until the problem has been rectified.

ADDITIONAL FEATURES

1. The base of the pressure cooker has been specially designed for extra strength and even heat distribution.
2. The base thickness of this pressure cooker is greater than in common units, providing extra heat absorption.
3. No steam release is required. As a result, less water is used during cooking. The pressure cooker does not make noise or release food aromas. With the right amount of heat, the pressure cooker will work on its own.

**SUITABLE HEAT SOURCES FOR THIS PRESSURE COOKER:
THIS PRESSURE COOKER IS MADE WITH EXTRA
HARD ALUMINUM.
THE PRESSURE COOKER IS SUITABLE FOR USE ON
GAS STOVES.**

7. DIRECTIONS FOR PROPER USE

This product is intended for household use only. Do not use the pressure cooker for other than its intended purpose.

MAGEFESA pressure cookers are ideal to prepare foods that require longer cooking times such as soups, meats (stews and goulash), vegetables, potatoes, some cereals and desserts.

Depending on the food quantity and the overall size of the pressure cooker, it may be used for pressure canning.

This product cooks food under pressure. Caution should be taken when operating this pressure cooker to avoid scalding injury.

This pressure cooker is made of aluminum. However, material damage can result from mistreatment or improper use.

Please, follow the instructions provided in this manual closely.

8. USING THE COOKER FOR THE FIRST TIME

Prior to using the pressure cooker, wash the pot, lid and gasket with hot water and dish soap. In order to sterilize the cooker and get rid of any residue or dust particles we recommended boiling water in the pressure cooker pot, one-half (1/2) full, with the lid off.

Once the pressure cooker has been washed thoroughly, coat the inside of the pot with a few drops of cooking oil using a paper towel. When cooking on electric stoves, the diameter of the pressure cooker base should match that of the hotplate or ring. If you are using a gas stove, do not allow flames to exceed beyond the base of the pot. Should this occur, the surface will become discolored and the helper handles (9) will retain heat and become damaged.



9. FILLING THE PRESSURE COOKER

1. Do not fill the pot more than two-thirds ($2/3$) of its capacity. This includes both the liquids and food contents added to the pressure cooker. (FIG. 4.1)
2. When preparing foods that expand during the cooking process like rice, cereals or dried food, do NOT fill the pot over one-half ($1/2$) of its capacity. (FIG. 4.2)

If the unit is overfilled, safety features may become impaired, increasing the risk of scalding.

3. ALWAYS add liquid to the pressure cooker pot. When using your pressure cooker to prepare foods, except for steaming, use at least 1.05 Qts of liquid (1 L).

This way you will avoid dry cooking, preventing burnt and stuck on food. Remember that using less liquid than the recommended amount will result in damages to the pressure cooker due to overheating. (FIG. 4.3)

4. Note that certain foods such as barley, fruits and pasta produce foams that block the pressure release systems (swivel and security valves). These foods should not be cooked in a pressure cooker.

5. To prevent damage to the aluminum surface it is important to add the salt once the contents inside the cooker start boiling, as this will help it dissolve completely. Once cooking time has elapsed, avoid keeping your food inside the pressure cooker for too long, as the acidic elements and salt in food can cause corrosion and pitting when in contact with the aluminum for prolonged periods of time.

Maximum fill level



Minimum fill level



ATTENTION: BEFORE USING THE PRESSURE COOKER, CHECK THAT THE KNOB SAFETY BOLT, STEAM PIPE AND SECURITY VALVE ARE PERFECTLY TIGHT IN THE RIGHT PLACE.

10. CHECKING THE VALVES

Valves are safety features. Before you use your pressure cooker always check the valves for clogging, as this can impair their function.

1. Steam pipe (23):

Remove the lid (1) and the swivel valve (22). Check from the inside part of the lid that the steam pipe (23) is completely clean. Otherwise, clean it using a thin rod. (FIG. 5.1)

2. Safety valve (7):

Make sure the safety valve (7) functions properly by pressing it with a thin rod from inside the lid (1). (Fig 5.2)

If the valve is able to move up and down freely that means it is functioning correctly (FIG. 2). If the valve is blocked, dismantle and clean with warm water and neutral soap. If the problem continues, stop using and take to the nearest official MAGEFESA technical center before reusing.

If the valves malfunction or become inoperable, take the pressure cooker to an official MAGEFESA technical center. It will become necessary to check both of the above safety devices.



FIG.5.1



FIG.5.2

11. SECURING THE PRESSURE COOKER LID

1. Make sure the silicone gasket is properly fitted into the lid.
2. With the tightening knob (33) turned to its lower position (rotating it counterclockwise) (FIG. 6.1), place the lid (1) onto the body (11) (FIG. 6.2) making sure it gets properly fitted by sliding the fingers around it.
3. Rotate the tightening knob (33) clockwise. (FIG. 6.3)
4. Proceed to definitive closure by giving the tightening knob 1.1/2 to 2 turns until the clamp bar (35) stays tight under the side clamps (37) and the lid is well closed.
5. Place the swivel valve (22) weight on the steam pipe (8). (FIG. 6.4)



FIG.6.1



FIG.6.2



FIG.6.3



FIG.6.4

12. COOKING UNDER PRESSURE

1. Place food ingredients inside the cooker, close and place the swivel valve (7) correctly onto the steam pipe (23). Place pressure cooker on the heat source, regulated to maximum.
2. After a while, the built-up pressure inside the cooker will make the swivel valve (22) rotate and you will observe the pressure releasing through it. At this point the heat intensity should be reduced, in order to maintain a light steady pressure release.
3. Cooking times should start to be counted at this point.
(Section 17: Cooking times chart)
4. While cooking it is NORMAL to observe small amounts of steam coming out of the safety valve (7).
5. If you use a gas burner make sure the flame is adjusted from the beginning and the pressure cooker is placed centrally on the burner, in order to avoid the flame extending beyond the base.
This way, we will be able to save energy and prevent deterioration of the helper handles (9) and silicone gasket (8).

Please note the following:

- Never leave an empty pressure cooker on a hot burner.
- Should you notice any problem during cooking, remove the pressure cooker from the heat source and allow it to cool down completely. (Section 15)
- To avoid damages to your pressure cooker, always cook with the minimum amount of water / liquid recommended in this manual. Do NOT allow your pressure cooker boiling dry.
- Open the pressure cooker with caution. Keep face and body at a distance as hot steam may still remain inside the pressure cooker.
- Please make sure the food you are preparing is suitable for pressure cooking.
- Do not use this pressure cooker for pressure frying with oil.



ATTENTION: DO NOT USE THIS PRESSURE COOKER FOR PRESSURE FRYING WITH OIL.
ALWAYS USE AT LEAST 1.05 QTS (1 L) OF LIQUID WHEN COOKING IN YOUR PRESSURE COOKER.

ATTENTION: IF THE PRESSURE COOKER HAS BEEN HEATED WITHOUT ANY CONTENTS OR FOOD, SEEK ADVICE FROM THE NEAREST AUTHORIZED TECHNICIAN BEFORE USING IT AGAIN.

ATTENTION: ALWAYS OPEN THE PRESSURE COOKER WITH CAUTION. KEEP FACE AND BODY AT A DISTANCE AS HOT COOKING STEAM MAY REMAIN INSIDE THE UNIT.

ATTENTION: NEVER PLACE THE PRESSURE COOKER IN A HEATED OVEN.

13. PRESSURE RELEASE METHODS

When the required cooking time has elapsed remove the pressure cooker from the heat. Then proceed in either of the following manners as the recipe directs.

- **Natural Pressure Release:** Remove the pressure cooker from the heating element and allow it to cool. Depending on the amount of food and liquid in the pressure cooker this method may take around 10 to 15 minutes. Once cooled, remove the swivel valve (22) to release the pressure. (Fig. 8.1) If there is still some steam left inside the pressure cooker, it will be released through the steam pipe (8).
- **Fast Pressure Reduction:** Transfer the pressure cooker to the sink. Run cold water over the lid, remove the swivel valve (22) (Fig. 8.1) and wait for the steam to dissipate completely. This method is used to release pressure as quickly as possible. It is primarily used when preparing vegetables, seafood or other tender foods that overcook easily.

Once pressure has been released, open the cooker by rotating the tightening knob (33) anti clockwise, until the clamp bar (35) lowers as far as it can go. Slid the lid (1) horizontally to remove completely. (Fig. 8.2) Use caution when opening as hot cooking steam may be released. Once all the pressure inside the cooker has been released, gently shake the cooker before removing the lid, especially if cooking grains, purees, and foods with high-fat content or sauces. This will prevent food ejection. Do NOT force the lid open.



FIG.7



FIG.8.1



FIG.8.2

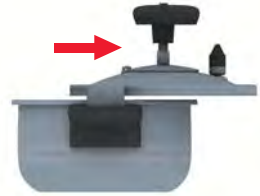

FIG.8.3

PRESSURE REDUCTION TIPS FOR SPECIFIC FOODS:

- *Foods that require short cooking time:*
Use the fast pressure release method when preparing rice or vegetables, since such foods can easily overcook.
- *Dried pulses and vegetables that require long cooking time, soups, meat stews, potatoes and cereals:*
Use the natural pressure release method. Do not use water to cool the pot. Foods like potatoes may, as a result, fall apart.
- *Meats, vegetables, frozen vegetables, fresh Fruits, dried Foods (not including pulses):*
Use the natural pressure release or fast pressure release method.
- *Fish and risotto:*
Use the fast pressure release method.
- *Foods with a high fat content or purees:*
Use the natural pressure release method. Gently shake the pressure cooker prior to opening to prevent splashing. Meats with skin (e.g. ox tongue) may swell when cooking under pressure. Do not pierce meat while the skin is swollen as this may result in scalding injury.

14. CLEANING AND CARE INSTRUCTIONS

TO MAINTAIN YOUR PRESSURE COOKER IN ITS ORIGINAL STATE FOLLOW THE INSTRUCTIONS SET OUT BELOW. (FIG. 9.1 - 9.2 - 9.3)

Wash in warm water using mild dish soap and a non-abrasive cleaning pad or sponge. Rinse thoroughly and dry.

Do NOT place the pressure cooker or any of its components in the dishwasher. The aluminum surface may become damaged and discolored after several hot water washing cycles and exposure to salt.



FIG.9.1



FIG.9.2



FIG.9.3

LID

Do not place the pressure cooker lid or any of its components in a dishwasher as this may result in damages to the safety features.

Clean the steam pipe with a thin rod, and the security valve, pressing it with the same rod from inside the lid.

Next, run a stream of tap water over the lid. Never attempt dismantling the swivel valve.

BODY

Wash your pressure cooker pot the same way would do with any other aluminum cookware.

1. The use of certain ingredients or food additives, and the exposure to water lime content may cause the appearance of bluish or yellowish stains in the bottom of the pressure cooker. To remove such stains or any other discoloration, add one-half (1/2) cup of lemon juice and 1 to 2 cups of water to the pressure cooker pot. Cook the liquid contents at high pressure for 15 minutes, and remove the pot from the heating element. Allow 10 to 15 minutes for the pressure cooker pot to cool completely. Once cooled, release the steam using the quick release method and wash the pressure cooker pot according to the instructions provided.
2. Do NOT use corrosive detergents like bleach, or diluted solutions, to clean the pressure cooker pot.



ATTENTION: DO NOT USE CORROSIVE DETERGENTS LIKE BLEACH (NOT EVEN DILUTED IN WATER) OR ANY OTHER STRONGLY ACIDIC CLEANERS TO CLEAN THE PRESSURE COOKER POT.

KNOB

If you use your pressure cooker often, we recommend revising the tightening knob periodically to make sure the bakelite is not worn out. If you notice any cracks or chipping in it, it will become necessary to be replaced for a new one.

SILICONE GASKET

The gasket is made of highly resistant silicone (over 500 times of efficient operation). Wash the gasket with warm, soapy water every time you wash the lid, without removing it from its place. After a long period of use it must be replaced with a new ORIGINAL MAGEFESA silicone gasket to prevent any possible steam leak from the pressure cooker and to guarantee its correct functioning. Proceed in the following way:

1. Remove the gasket and clean the ring around the edge of the lid where it sits.
2. Moisten the new gasket with warm soapy water.
3. Place the gasket back into the place. With the help of a spoon press it down until it is properly fitted into the ring around the edge of the lid.



ATTENTION: THE SILICONE GASKET IS CONSIDERED WORN OUT WHEN THE PRESSURE COOKER BEGINS TO LOSE STEAM AND DOES NOT MAINTAIN PRESSURE. THE SILICONE GASKET SHOULD BE REPLACED APPROXIMATELY EVERY TWO (2) YEARS TO ENSURE PROPER FUNCTIONING OF THE PRESSURE COOKER.

ATTENTION: DO NOT CLEAN THE PRESSURE COOKER OR ITS PARTS IN A DISHWASHER.

Do not remove stains or baked-in marks with abrasive tools such as knives and emery cloths. Instead, soak the pressure cooker pot in hot water, and then apply detergent to gently remove stains using a soft brush, sponge, or cloth. Do not use corrosive agents like bleach (or diluted forms) for cleaning.

If it becomes difficult to close the pressure cooker lid, apply a light layer of cooking oil to the silicone gasket.

Do not lock the lid in place when storing the pressure cooker. Instead, place the lid facing upside-down in the pot, so stress is not placed on the silicone gasket.

15. TECHNICAL SUPPORT AND REPLACEMENT PARTS

Do not modify the pressure cooker, its parts, or its safety features in any way. The use of replacement parts made by different manufacturers can affect the operating safety of your pressure cooker. MAGEFESA is not liable for the direct, indirect, special, incidental or consequential damages caused by the use of replacement parts from other manufacturers. Use authentic replacement parts manufactured and distributed by MAGEFESA only. When contacting our Customer Service Department through the contact section on our website, please have the information about your pressure cooker model and the replacement part you require at hand. You can check the pressure cooker components chart on *section 5* if you need any help identifying your replacement part. For technical support, replacement parts purchasing or any further information you may require, please contact your local retailer or an Authorized Magefesa Service Center in your area.

16. PRACTICAL TIPS FOR PRESSURE COOKER USE

Before you use your pressure cooker it's important you become familiar with the way your pressure cooker operates. Should you have any concerns about your pressure cooker or its safety features, please do not use it and contact your local retailer or MAGEFESA for assistance. Below you will find some practical tips and common solutions to minor problems you may experience when using your pressure cooker:

CASE: PRESSURE CAN NOT BE MAINTAINED

POSSIBLE REASONS:	SUGGESTIONS:
<ol style="list-style-type: none"> 1. The pressure cooker lid might not be well fitted onto the body. 2. Silicone gasket is out of place, dirty, or worn out. 3. Not enough liquid has been added, or remains inside the pressure cooker. 	<ol style="list-style-type: none"> 1. Reopen the pressure cooker and secure the lid according to the instructions provided, in this manual making sure it is properly closed. 2. Check the silicone gasket is clean and properly fitted into place. Make sure it is not worn out. We recommended replacing the gasket every 2 years. 3. Add water or any other liquid to cooker until the recommended minimum amount is reached.

CASE: STEAM ESCAPING FROM THE LID

POSSIBLE REASONS:	SUGGESTIONS:
<ol style="list-style-type: none"> 1. The pressure cooker lid might not be well fitted onto the body. 2. Silicone gasket is out of place, dirty, or worn. 3. The pressure cooker is overfilled. 	<ol style="list-style-type: none"> 1. Reopen the pressure cooker, and secure the lid according to the instructions provided, ensuring the unit is properly closed. <i>Section 11.</i> 2. Make sure the silicone gasket is clean, properly fitted into place and not worn out. To improve the silicone gasket's sealing performance, rub it gently with cooking oil or moisten with water. We recommend replacing the gasket every 2 years. 3. Do NOT fill the pressure cooker more than two-thirds (2/3) full. For foods with a tendency to foam, only fill one-half (1/2) of the pressure cooker. <i>Section 9.</i>



CASE: THE SWIVEL VALVE DOES NOT TURN

POSSIBLE REASONS:	SUGGESTIONS:
<ol style="list-style-type: none">1. Not enough liquid has been added, or remains inside the pressure cooker.2. The steam pipe is dirty.	<ol style="list-style-type: none">1. Add water or any other liquid to cooker until the recommended minimum amount is reached.2. Clean the steam pipe with a thin rod.

CASE: EFFORT IS REQUIRED TO OPEN OR CLOSE THE LID

POSSIBLE REASONS:	SUGGESTIONS:
<ol style="list-style-type: none">1. Pressure may remain inside the pressure cooker.2. Silicone gasket is out of place, dirty, or worn out.3. Pressure cooker clamp bar is not properly fitted under the side clamps.	<ol style="list-style-type: none">1. Proceed with one of the pressure release methods found in <i>Section 13</i>.2. Make sure the silicone gasket is clean and fitted into place. Make sure it is not worn out. We recommend replacing the gasket every 2 years3. Do NOT force the lid when opening or closing. If you feel you need to apply pressure when closing the lid, open the lid by rotating the knob counterclockwise. Next, follow the instructions provided on <i>Section 11</i> to make sure the clamp bar stays tight under the side clamps and the lid is properly closed.

CASE: THE STEAM COMING OUT THE SWIVEL VALVE CONDENSATES ON THE LID

POSSIBLE REASONS:	SUGGESTIONS:
<ol style="list-style-type: none">1. While the pressure cooker is working you will observe light steady steam coming out the swivel valve, and drops of steam condensate on the lid.	<ol style="list-style-type: none">1. This is considered as part of the normal operation of your pressure cooker.

17. COOKING TIMES CHART

The cooking system of this pressure cooker reduces cooking times when compared to conventional cooking methods, helping you save energy. As both the amount of water used during cooking and cooking times are reduced, pressure cooking preserves a greater amount of the food's nutrients, vitamins and minerals, improving also its natural flavor and texture.

The operating pressure of this pressure cooker is 7.2 psi (50 kPa)

Cooking times should be counted from the moment the steam starts coming out the swivel valve.

At his point the heat should be reduced to a minimum to maintain the pressure inside the cooker.

They should be taken as guidance, as they may vary according to food, cut, water used and personal taste of the user.

Minimum amount of liquid required for pressure cooking 1.05 Qts (1 L)

FOOD	COOKING TIME (MIN)	LIQUID ADDED
VEGETABLES		
Chard	3	300 ml / 10 oz
Artichokes	12 / 14	1/2 level mark
Celery	4	300 ml / 10 oz
Celery, chopped	2	300 ml / 10 oz
Sweet potatoes	8 / 10	300 ml / 10 oz
Broccoli	2 / 4	300 ml / 10 oz
Pumpkin, chopped	10 / 12	1/2 level mark
Zucchini	4 / 6	300 ml / 10 oz
Onion	6 / 8	300 ml / 10 oz
Brussels sprouts	4 / 6	300 ml / 10 oz
Chucrut	20 / 25	300 ml / 10 oz
Cauliflower	4 / 6	300 ml / 10 oz
Turnip, halved	6	300 ml / 10 oz
Turnip, sliced	2	300 ml / 10 oz
Asparagus	8 / 10	1/2 level mark
Spinach, fresh	2 / 3	300 ml / 10 oz
Spinach, frozen	4 / 5	300 ml / 10 oz
Endives, whole	2 / 3	300 ml / 10 oz
Peas, fresh	3 / 5	300 ml / 10 oz
Fennel	4 / 6	300 ml / 10 oz
Green beans	6 / 10	300 ml / 10 oz
Red cabbage	10	1/2 level mark
Corn Cobs	6 / 8	1/2 level mark
Mixed vegetables, chopped (frozen)	8 / 10	300 ml / 10 oz
Turnip	8 / 10	300 ml / 10 oz
Turnip, chopped	5 / 6	300 ml / 10 oz
Leek	4 / 5	300 ml / 10 oz
Leek, chopped	2	300 ml / 10 oz

* At least 1.05 Qts (1 L)



FOOD	COOKING TIME (MIN)	LIQUID ADDED
Okra	4 / 6	300 ml / 10 oz
Red peppers	3 / 4	300 ml / 10 oz
Potatoes, whole	12 / 14	1/2 level mark
New potatoes, whole	8 / 10	1/2 level mark
Potatoes, diced	4 / 6	300 ml / 10 oz
Potatoes, sliced	2 / 4	300 ml / 10 oz
Beetroot, whole	25 / 30	1/2 level mark
White cabbage	6 / 8	300 ml / 10 oz
Salsify	10 / 12	1/2 level mark
Snow peas	6 / 8	300 ml / 10 oz
Tomatoes, whole	4 / 6	300 ml / 10 oz
Tomatoes, chopped	3 / 4	300 ml / 10 oz
Carrots, whole	8 / 10	1/2 level mark
Carrots, chopped	4 / 6	300 ml / 10 oz
RICE AND CEREALS		
Bahia, bomba, basmati, senia, jasmine rice	8 / 9	According to recipe, *
Brown rice	18 / 20	According to recipe, *
Wild rice	12 / 15	According to recipe, *
Corn Cobs	6 / 8	1/2 level mark
Cous cous	3 / 4	According to recipe, *
PULSES		
White beans	25 / 30	To cover up ingredients
Verdina beans	20 / 25	To cover up ingredients
Pinto beans	20 / 25	To cover up ingredients
Broad beans	6 / 8	According to recipe, *
Lentil	10 / 12	To cover up ingredients
Asturian white bean stew	25 / 30	To cover up ingredients
Chickpeas	40 / 45	To cover up ingredients
Pigeon beans	18 / 20	According to recipe, *
Soybean	10 / 12	According to recipe, *
SOUPS, STOCKS AND PUREES		
Poultry stock	25 / 30	According to recipe, *
Beef stock	40 / 45	According to recipe, *
Fish stock	12 / 15	According to recipe, *
Vegetable stock	12 / 15	According to recipe, *
Pea soup	8 / 10	According to recipe, *
Vegetable soup	6 / 8	According to recipe, *
Minestrone soup	6	According to recipe, *
Onion soup	6 / 8	According to recipe, *
FISH		
Clams	3 / 4	300 ml / 10 oz
Tuna, sliced	4 / 5	300 ml / 10 oz
Cod	2 / 3	300 ml / 10 oz

* At least 1.05 Qts (1 L)

FOOD	COOKING TIME (MIN)	LIQUID ADDED
Squid	8 / 10	According to recipe, *
Mussels	3 / 4	300 ml / 10 oz
Hake, sliced	3	According to recipe, *
Fish, loins	6	According to recipe, *
Fish, tails	4 / 5	According to recipe, *
Fish pieces	3 / 4	According to recipe, *
Fish fillets	2	According to recipe, *

MEAT, POULTRY AND GAME

Beef or ox, roast	40 / 45	According to recipe, *
Beef or ox, minced	8 / 10	According to recipe, *
Beef or ox, stew	25 / 30	To cover up ingredients
Beef, tongue	40 / 45	To cover up ingredients
Veal, roast	20 / 28	According to recipe, *
Veal, ossobuco or shank	35	According to recipe, *
Veal, stew	20	To cover up ingredients
Veal, tongue	25 / 30	To cover up ingredients
Veal, tripe	30 / 35	To cover up ingredients
Veal, feet	35	According to recipe, *
Pork, roast	20 / 25	According to recipe, *
Pork, bacon	18 / 20	According to recipe, *
Pork, ribs	15	According to recipe, *
Pork, stew	20	To cover up ingredients
Pork, knuckle	30 / 35	To cover up ingredients
Pork, feet	30	According to recipe, *
Lamb, roast	25 / 30	According to recipe, *
Lamb, stew	18 / 20	To cover up ingredients
Lamb, chops	10 / 12	According to recipe, *
Lamb, feet	20 / 25	According to recipe, *
Chicken (whole), roast	18 / 20	According to recipe, *
Chicken, stew	8 / 10	To cover up ingredients
Hen	30 / 35	According to recipe, *
Pheasant, stew	15 / 18	To cover up ingredients
Turkey, stew	30 / 35	To cover up ingredients
Rabbit, stew	22 / 25	To cover up ingredients
Hare, stew	25 / 30	To cover up ingredients
Venison, stew	30	To cover up ingredients





















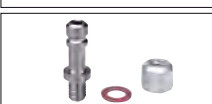

FRESH FRUIT AND DESSERTS

Apricots, peaches, plums, cherries	2 / 3	According to recipe, *
Chestnuts	10 / 12	According to recipe, *
Pears, apples	4 / 6	According to recipe, *
Quinces	10 / 12	According to recipe, *
Fruit compotes	6 / 8	According to recipe, *
Custard	10	According to recipe

* At least 1.05 Qts (1 L)

19. REPLACEMENT PARTS CHART

The following chart contains the most important replacement parts for your pressure cooker. Please, do not hesitate to visit our website (www.magefesausa.com) if you require further information.

	SPARE PART NAME	SPARE PART NUMBER	SPARE PART CODE	EAN 13	UPC-A
	- Helper handle	09	CHEF 09REMEASA15	 8 429113 543154	 6 13310 01448 4
	- Safety valve	07	CHEF 09REMEVSC15	 8 429113 543152	 6 13310 01448 4
	- Knob	33	CHEF 09REMEPOC15	 8 429113 543153	 6 13310 01448 4
	- Working valve	22	CHEF 09REMEVTC15	 8 429113 543259	 6 13310 01448 4
	- Steam pipe	23	CHEF 09REMEHC15	 8 429113 543151	 6 13310 01448 4
	- Knob safety bolt	36	CHEF 09REMECHJ15	 8 429113 543259	 6 13310 01448 4
	- Silicone gasket	08	CHEF 15L 09REMEJUS15 CHEF 22L 09REMEJUS22	 8 429113 543179  8 429113 543222	 6 13310 01448 4  6 13310 01448 4



MAGEFESA USA
3325 NW 70th Avenue
Miami, FL 33122-1332
Telephone: (786) 594-3781
Fax: (786) 594-3782
Email: info@magefesausa.com
www.magefesausa.com