

Ficha Técnica

Cocina Serie 750 EV Coup de feu - Cocinas todo plancha

Jemi Simply built to last
Professional Dishwashing and Cooking Equipment

Mod. TP764 EV

Características

Dimensiones exteriores 1200 x 750 x 850 mm.

Peso 132Kg.

Consumo gas Hi (15°C 1013,25 mbar)

Gas natural H G20 Hi = 34.02 MJ / m³ 2,47

G.P.L. G30 / G31 Hi = 45.65MJ / kg 2,31

Numero de quemadores fuego abierto 4 de ø 120 mm.

numero de quemadores placa 1 de ø 120 mm.

Potencia quemador ø 120 mm. 7,4 Kw. / 6.300 Kcal/h.

Potencia quemador placa 9,88 Kw. / 8.495 Kcal/h.

Entrada gas 3/4"

Potencia calorífica nominal 39,48 Kw.

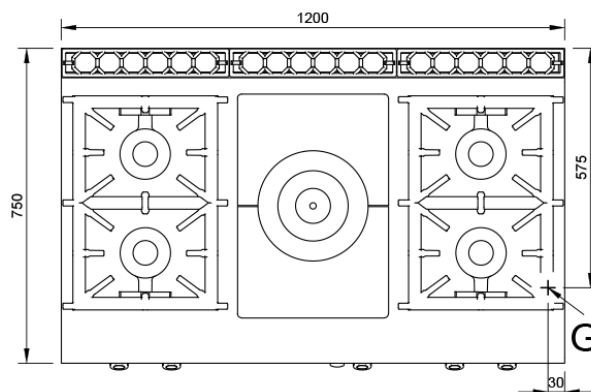
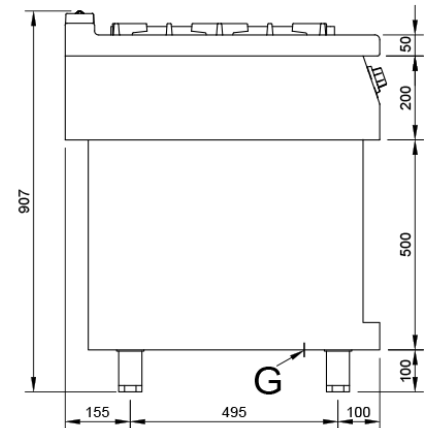
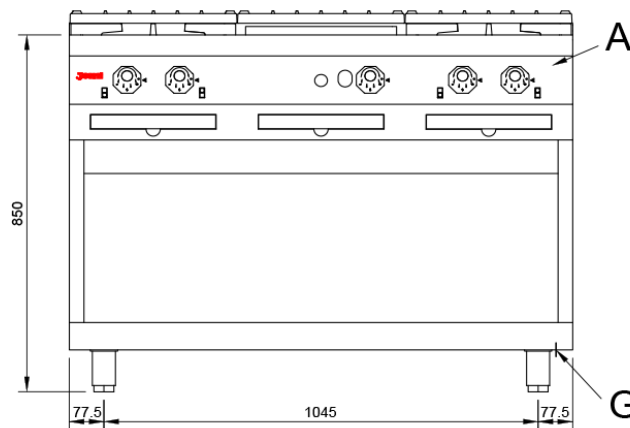

Leyenda

A. Placa de características (frontal interior)

G. Entrada gas 3/4".
Potencia: 39,48 Kw.
33.700 Kcal/h.

