

Ficha Técnica

Cocina Serie 900 EV Baños María Eléctricos

Mod. BME20 EV

Características

Dimensiones exteriores 400 x 900 x 850 mm.

Peso 70 Kg.

Voltaje 230V. II + T

Dimensiones interiores 305 x 687 x 170 mm.

GN 1/1 + GN 1/3

Litros 27

Potencia eléctrica 2,25 Kw.



COMBINACIÓN SERIE 900

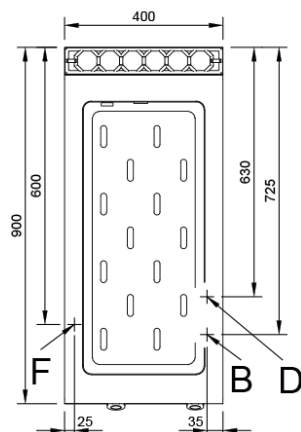
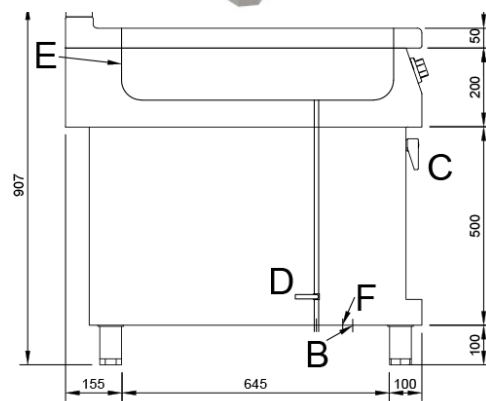
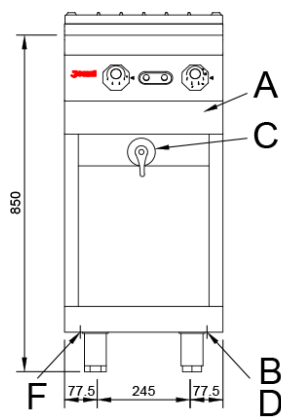
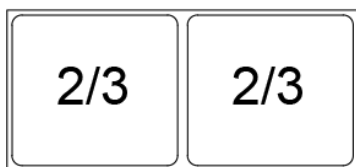
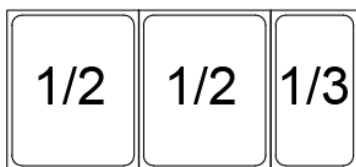
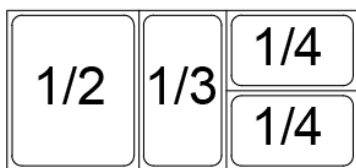
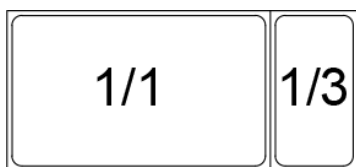

Leyenda

- A. Placa de características (frontal interior)
- B. Entrada agua 1/2".
- C. Grifo de llenado.
- D. Desagüe.
- E. Nivel de agua.
- F. Entrada eléctrica 230V. II + T.
Potencia: 2,25 Kw.

