

# IBK-1

## ICE BAGGER KIT

### FEATURES CARACTERÍSTICAS

- ▶ **THE ITV IBK-1 ICE BAGGER WILL MAKE YOUR ICE BAGGING A QUICK AND EASY OPERATION.**  
LA EMBOLSADORA DE HIELO ITV IBK-1 HARÁ QUE EMBOLSAR EL HIELO SEA UNA OPERACIÓN RÁPIDA Y FÁCIL.
- ▶ **MADE OF ANODIZED ALUMINIUM.**  
FABRICADA CON ALUMINIO ANODIZADO.
- ▶ **ICE CHUTE TUBE MADE OF POLYSTYRENE FOR ALIMENTARY PURPOSES.**  
TUBO CÁIDA HIELO DE POLIESTIRENO ALIMENTARIO.
- ▶ **BAGS WITH A CAPACITY OF 4KG (275X550MM).**  
BOLSAS CON CAPACIDAD DE 4KG (275X550MM).
- ▶ **ZIPPER BAGS WITH LAMINATED WIRE.**  
CIERRE BOLSAS MEDIANTE ALAMBRE PLASTIFICADO.
- ▶ **COMPLEMENT: 2 KIT OF 50 BAGS & ZIPPERS.**  
DOTACIÓN: 2 KIT DE 50 BOLSAS & CIERRES.



### ACCESSORIES ACCESORIOS

**INCLUDED**



**BAGS KIT**  
KIT DE BOLSAS



**ZIPPERS KIT**  
KIT DE CIERRES



**SCOOP**  
PALA

### RECOMMENDED BINS SILOS RECOMENDADOS



S 160



S 220



S 350



S 400





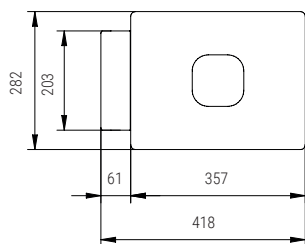
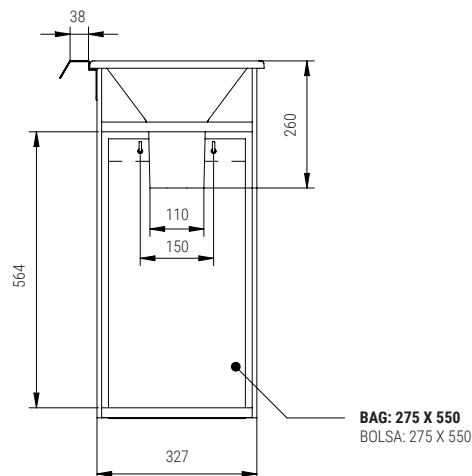
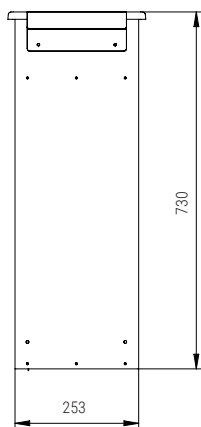





S 500



\* All measurements in mm.  
\* Todas las cotas en mm.

MODELS  
MODELOS

IBK-1

	 (mm)	 (Kg)	 (Lbs.)	 (mm)	 (mm)	 (Kg)	 (Kg)	 (m <sup>3</sup> )
Width	550	4	8,8	Width	377	5,85	7	0,08
Depth	-			Depth	302			
Height	80			Height	742			