

# 07 VITRINA EXPOSITORA PARA PESCADO SERIE MÁLAGA

## FISH DISPLAYS CASE MALAGA SERIES

### EXTERIOR

- Acero Inox AISI 304 18/10
- Cristal curvo securizado
- Encimera de trabajo en acero inox AISI 304 18/10
- Bancada en acero esmaltado
- Puertas traseras correderas

### INTERIOR

- Acero Inox AISI 304 18/10
- Desagüe interior
- Iluminación LED 

### AISLAMIENTO

- Poliuretano inyectado alta presión libre de CFC 's densidad 40 kg/m<sup>3</sup>, bajo GWP y cero efecto ODP

### REFRIGERACIÓN

- Estática por gravedad y placa fría en bandeja
- Evaporadores tratados anticorrosión 100% Poliéster

### EXTERIOR

- AISI 304 18/10 stainless steel
- Curved tempered security glass system
- AISI 304 18/10 stainless steel worktop
- Enamelled steel base
- Sliding door back

### INTERIOR

- AISI 304 18/10 stainless steel
- Internal drain
- LED lighting 

### INSULATION

- Free CFC's high density [40kg/m<sup>3</sup>] polyurethane insulation with low GWP & zero ODP effect





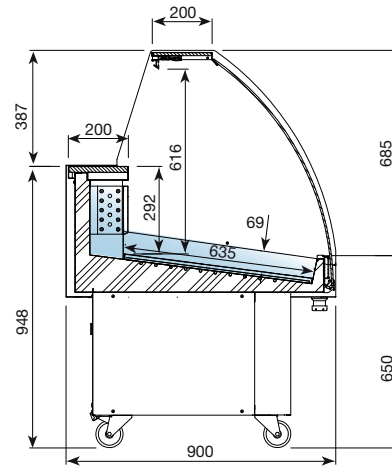



### REFRIGERATION

- Static by gravity coil and cold plate refrigeration system on the bottom
- Evaporator coil coated with anti-corrosion material 100% Polyester



VML

07 V. expositoras

MODELOS MODELS														
	Dimensiones sin costados Dimensions without sides LxPxH (mm)	Costados Sides (Z)(mm)	Potencia Power (W)	Electrica Electrical (V/Hz)	Superficie exposición (m <sup>2</sup> )	Compresor Compressor (HP)	Consumo Consumption (kWh/24h)		Evaporación Evaporation	Régimen T <sup>RA</sup> (32°C)	Desescarche Defrost	Potencia frigorífica Refrigerating power (W a -10°C)	Control Control	Refrigerante Refrigerant
VML 12	1250x900x1335	40+40	620	220/50	0,79	1/3	8,7		Estática+Placa Static+Cold plate	-1°C/+1°C	Manual	800	Digital	R 134 a
VML 15	1562x900x1335	40+40	895	220/50	0,99	1/2	12,5		Estática+Placa Static+Cold plate	-1°C/+1°C	Manual	1208	Digital	R 134 a
VML 18	1875x900x1335	40+40	1094	220/50	1,19	7/8	15,3		Estática+Placa Static+Cold plate	-1°C/+1°C	Manual	1606	Digital	R 134 a

Características técnicas y constructivas sujetas a variación sin previo aviso / We reserve the right to change specifications without prior notice.

**EXTERIOR**

- Acero Inox AISI 304 18/10
- Cristal recto templado
- Encimera de trabajo en acero inox AISI 304 18/10
- Puertas correderas traseras

**INTERIOR**

- Acero Inox AISI 304 18/10
- Desagüe interior
- Iluminación LED 

 **AISLAMIENTO**

- Poliuretano inyectado alta presión libre de CFC 's densidad 40 kg/m<sup>3</sup>, bajo GWP y cero efecto ODP

**RUEDAS**

- Diámetro 100 mm. Traseras con freno.

**REFRIGERACIÓN**

- Estática por gravedad y placa fría en bandeja
- Evaporadores tratados anticorrosión 100% Poliéster

**EXTERIOR**

- AISI 304 18/10 stainless steel
- Flat tempered security glass system
- AISI 304 18/10 stainless steel worktop
- Sliding door back

**INTERIOR**

- AISI 304 18/10 stainless steel
- Internal drain
- LED lighting 

**INSULATION**

- Free CFC's high density (40kg/m<sup>3</sup>) polyurethane insulation with low GWP & zero ODP effect

**CASTERS**

- 100 mm. diameter. Rear brake casters.

**REFRIGERATION**

- Static by gravity coil and cold plate refrigeration system on the bottom
- Evaporator coil coated with anti-corrosion material 100% Polyester

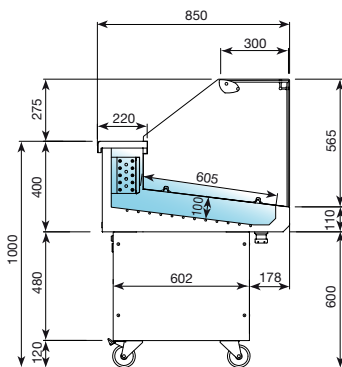

VRP 13

**OPCIONAL / OPTIONAL**

- Doble acristalamiento / Double panel glass **+180 €**

MODÈLES	Dimensiones Dimensions LxFxH (mm)	Potencia Power [W]	Electrica Electrical [V/Hz]	Capacidad Capacity [L]	Superficie exposición [m <sup>2</sup> ]	Compresor Compressor [HP]	Consumo Consumption [kWh/24h]	Evaporación Evaporation	Régimen T <sup>MA</sup> [32°C]	Desescarche Defrost	Potencia frigorífica Refrigerating power [W a -10°C]	Control Control	Refrigerante Refrigerant
VRP 13	1320x850x1275	475	220/50	115	0,75	1/4	6,7	Estática+placa Static+cold plate	-1°C/+1°C	Manual	464	Digital	R 134 a

Características técnicas y constructivas sujetas a variación sin previo aviso / We reserve the right to change specifications without prior notice.

VITRINA EXPOSITORA REFRIGERADA CARRO PARA PESCADO SERIE VRP  
FISH DISPLAYS CASE VRP SERIES



VRP 13



Frontal abatible / Front opening glass

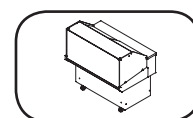

VRP 13

2.485 €



DECORACIÓN CHAPA PLASTIFICADA FRONTAL · FRONTAL LAMINATED PLATE DECORATION



DECORACIÓN LACADA · LACQUED DECORATION



07 V. expositoras

ACABADOS POR MÓDULO ENDED BY UNIT	PLASTIFICADO FRONTAL FRONTAL LAMINATED PLATE	LACADO FRONTAL + COSTADOS FRONTAL LACQUED + SIDES	LACADO TOTAL TOTAL LACQUED
VMC 9	<b>Standar</b>	(DFCVBMC9) <b>150 €</b>	(DFTVMC9) <b>200 €</b>
VMC 12	<b>Standar</b>	(DFCVBMC12) <b>170 €</b>	(DFTVMC12) <b>220 €</b>
VMC 15	<b>Standar</b>	(DFCVBMC15) <b>200 €</b>	(DFTVMC15) <b>240 €</b>
VMC 18	<b>Standar</b>	(DFCVBMC18) <b>230 €</b>	(DFTVMC18) <b>260 €</b>
VMC 25	<b>Standar</b>	(DFCVBMC25) <b>280 €</b>	(DFTVMC25) <b>300 €</b>

VITRINA EXPOSITORA REFRIGERADA CARRO PARA PESCADO SERIE VRP  
FISH DISPLAYS CASE VRP SERIES



VRP 13



Frontal abatible / Front opening glass

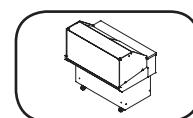

VRP 13

2.485 €

VITRINA EXPOSITORA PARA PESCADO SERIE MÁLAGA  
FISH DISPLAYS CASE MALAGA SERIES



VML 18



07 V. expositoras

OPCIONAL / OPTIONAL

MODELOS MODELS	Iluminación LED frontal Frontal LED lighting
VML 12	(LUDECVMD12) <b>64 €</b>
VML 15	(LUDECVMD15) <b>79 €</b>
VML 18	(LUDECVMD18) <b>95 €</b>

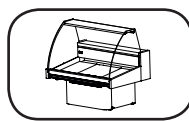

VML 12

2.588 €

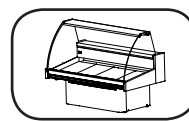

VML 15

2.826 €

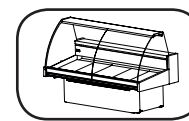

VML 18

3.081 €



# 07 VITRINA EXPOSITORA SERIE ALMERÍA DISPLAY CASE ALMERIA SERIES

## EXTERIOR

- Chapa de acero plastificada
- Cristal curvo securizado
- Bancada en acero esmaltado
- Claro de puerta de acceso media reserva 445x265

## INTERIOR

- Chapa de acero plastificada
- Plano de exposición en acero esmaltado
- Iluminación en perfil superior
- Ventiladores en reserva

## AISLAMIENTO

- Poliuretano inyectado alta presión libre de CFC 's densidad 40 kg/m<sup>3</sup>, bajo GWP y cero efecto ODP

## REFRIGERACIÓN

- Semi Estática por gravedad
- Evaporadores tratados anticorrosión 100% Poliéster

## EXTERIOR

- Laminated steel plate
- Curved tempered security glass system
- Enamelled steel base
- Storage door opening 445x265

## INTERIOR

- Laminated steel plate
- Enamelled exhibition steel surface
- Upper profile lighting
- Storage fans

## INSULATION

- Free CFC's high density (40kg/m<sup>3</sup>) polyurethane insulation with low GWP & zero ODP effect

## REFRIGERATION

- Semi Static by gravity coil
- Evaporator coil coated with anti-corrosion material 100% Polyester

## OPCIONAL / OPTIONAL

MODELOS MODELS	Puertas correderas traseras Rear sliding doors	Estante Shelf
VLMR 1000	(PUEVLMR10CT) <b>94 €</b>	(ESTLMRGRD10) <b>53 €</b>
VLMR 1500	(PUEVLMR15CT) <b>140 €</b>	(ESTLMRGRD15) <b>75 €</b>
VLMR 2000	(PUEVLMR20CT) <b>190 €</b>	(ESTLMRGRD20) <b>106 €</b>
VLMR 2500	(PUEVLMR25CT) <b>236 €</b>	(ESTLMRGRD25) <b>124 €</b>
VLMR 3000	(PUEVLMR30CT) <b>287 €</b>	(ESTLMRGRD30) <b>147 €</b>

## DECORACIÓN CHAPA PLASTIFICADA / LAMINATED PLATE DECORATION

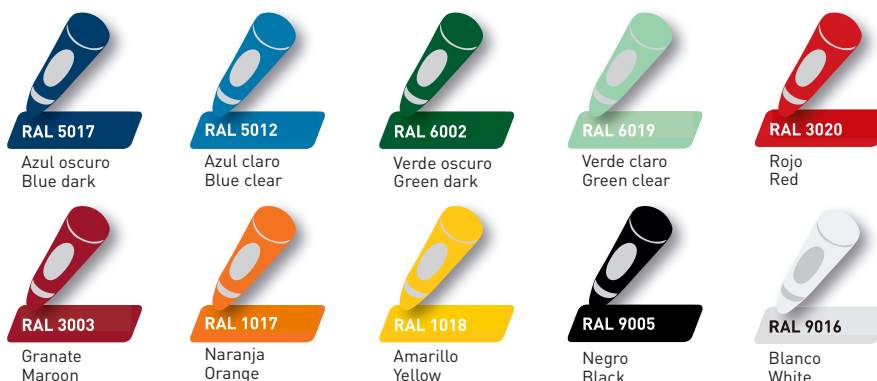

NOTA: La vitrina se suministra con los cristales y decoración desmontada  
NOTE: Display case provides with glasses and disassembled decoration

MODELOS MODELS	Dimensiones sin costados Dimensions without sides LxPxH (mm)	Costados Sides (2)mm	Potencia Power (W)	Electrica Electrical (W/Hz)	Capacidad Capacity (L)	Puertas Doors	Superficie exposición (m <sup>2</sup> )	Compresor Compressor (HP)	Consumo Consumption (kWh/24h)	Evaporación Evaporation	Régimen T <sup>TM</sup> (30°C)	Desescarche Defrost	Control Control	Refrigerante Refrigerant
VLMR 1000	945x805x1240	40+40	345	220/50	145	1	0,5	1/6	5,5	Estática Static	2°C/+6°C	Semi Automático Semi Automatic	Digital	R 404 A
VLMR 1500	1445x805x1240	40+40	560	220/50	222	2	0,5	1/4	9,0	Semi Estática Semi Static	2°C/+6°C	Semi Automático Semi Automatic	Digital	R 404 A
VLMR 2000	1888x805x1240	40+40	580	220/50	291	3	0,9	1/4	9,3	Semi Estática Semi Static	2°C/+6°C	Semi Automático Semi Automatic	Digital	R 404 A
VLMR 2500	2488x805x1240	40+40	670	220/50	383	4	1,2	1/3	10,7	Semi Estática Semi Static	2°C/+6°C	Semi Automático Semi Automatic	Digital	R 404 A
VLMR 3000	2888x805x1240	40+40	825	220/50	445	4	1,5	1/2	13,2	Semi Estática Semi Static	2°C/+6°C	Semi Automático Semi Automatic	Digital	R 404 A

Características técnicas y constructivas sujetas a variación sin previo aviso / We reserve the right to change specifications without prior notice.



VLMR 2500



VLMR 1500

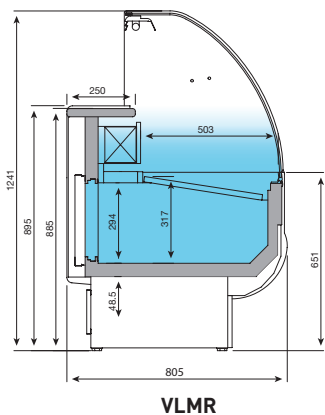

VLMR



VLMR 1000

1.454 €



VLMR 1500

1.722 €



VLMR 2000

2.043 €

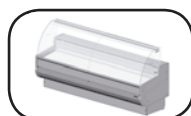

VLMR 2500

2.373 €

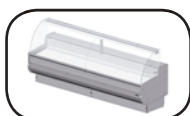

VLMR 3000

2.715 €

07 V. expositoras

**EXTERIOR**

- Chapa de acero plastificada
- Cristal curvo securizado
- Bancada en acero esmaltado
- Claro de puerta de acceso media reserva 445x265

**INTERIOR**

- Chapa de acero plastificada
- Plano de exposición en acero esmaltado
- Iluminación en perfil superior
- Ventiladores en reserva

**AISLAMIENTO**

- Poliuretano inyectado alta presión libre de CFC's densidad 40 kg/m<sup>3</sup>, bajo GWP y cero efecto ODP

**REFRIGERACIÓN**

- Semi Estática por gravedad
- Evaporadores tratados anticorrosión 100% Poliéster

**EXTERIOR**

- Laminated steel plate
- Curved tempered security glass system
- Enamelled steel base
- Storage door opening 445x265

**INTERIOR**

- Laminated steel plate
- Enamelled exhibition steel surface
- Upper profile lighting
- Storage fans

**INSULATION**

- Free CFC's high density (40kg/m<sup>3</sup>) polyurethane insulation with low GWP & zero ODP effect

**REFRIGERATION**

- Semi Static by gravity coil
- Evaporator coil coated with anti-corrosion material 100% Polyester

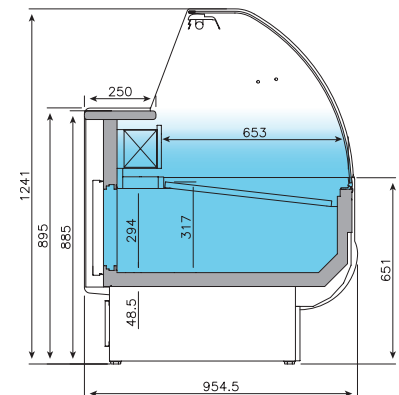
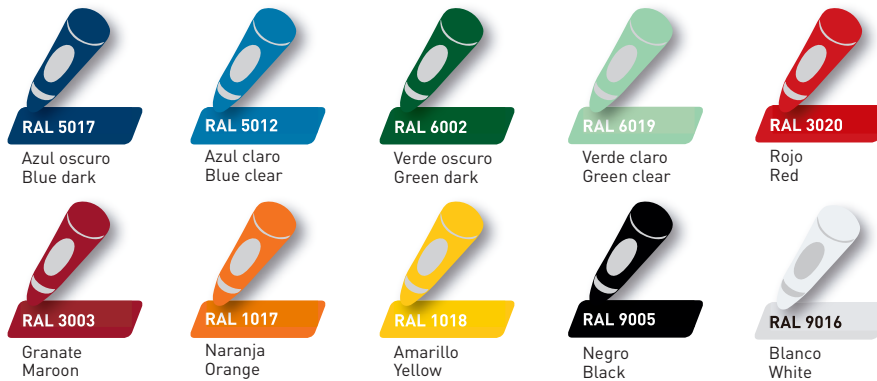
**DECORACIÓN CHAPA PLASTIFICADA / LAMINATED PLATE DECORATION****VGRD**

NOTA: La vitrina se suministra con los cristales y decoración desmontada  
NOTE: Display case provides with glasses and disassembled decoration

MODELOS MODELS	→ ↑ ↗ ↘ ↻ ⚡ 📦 📱 📺 🛒 🌊 🌡️ 🗑️ 🕒 🌡️	Dimensiones sin costados Dimensions without sides LxPxH (mm)	Costados Sides (2)(mm)	Potencia Power (W)	Electrica Electrical (W/Hz)	Capacidad Capacity (L)	Puertas Doors	Superficie exposición (m <sup>2</sup> )	Compresor Compressor (HP)	Consumo Consumption (kWh/24h)	Evaporación Evaporation	Régimen T <sup>RA</sup> (30°C)	Desescarche Defrost	Control Control	Refrigerante Refrigerant
VGRD 1000		945x955x1240	40+40	560	220/50	189	1	0,6	1/4	9,0	Estática Static	2°C/+6°C	Semi Automático Semi Automatic	Digital	R 404 A
VGRD 1500		1445x955x1240	40+40	580	220/50	289	2	0,9	1/4	9,3	Semi Estática Semi Static	2°C/+6°C	Semi Automático Semi Automatic	Digital	R 404 A
VGRD 2000		1888x955x1240	40+40	670	220/50	378	3	1,2	1/3	10,7	Semi Estática Semi Static	2°C/+6°C	Semi Automático Semi Automatic	Digital	R 404 A
VGRD 2500		2488x955x1240	40+40	825	220/50	498	4	1,6	1/2	13,2	Semi Estática Semi Static	2°C/+6°C	Semi Automático Semi Automatic	Digital	R 404 A
VGRD 3000		2888x955x1240	40+40	930	220/50	578	4	1,9	5/8	14,9	Semi Estática Semi Static	2°C/+6°C	Semi Automático Semi Automatic	Digital	R 404 A

Características técnicas y constructivas sujetas a variación sin previo aviso / We reserve the right to change specifications without prior notice.

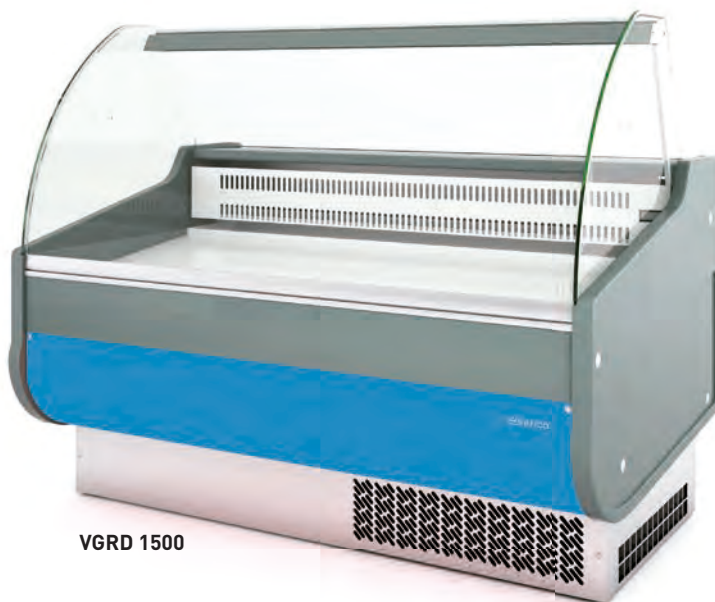

VGRD 1500

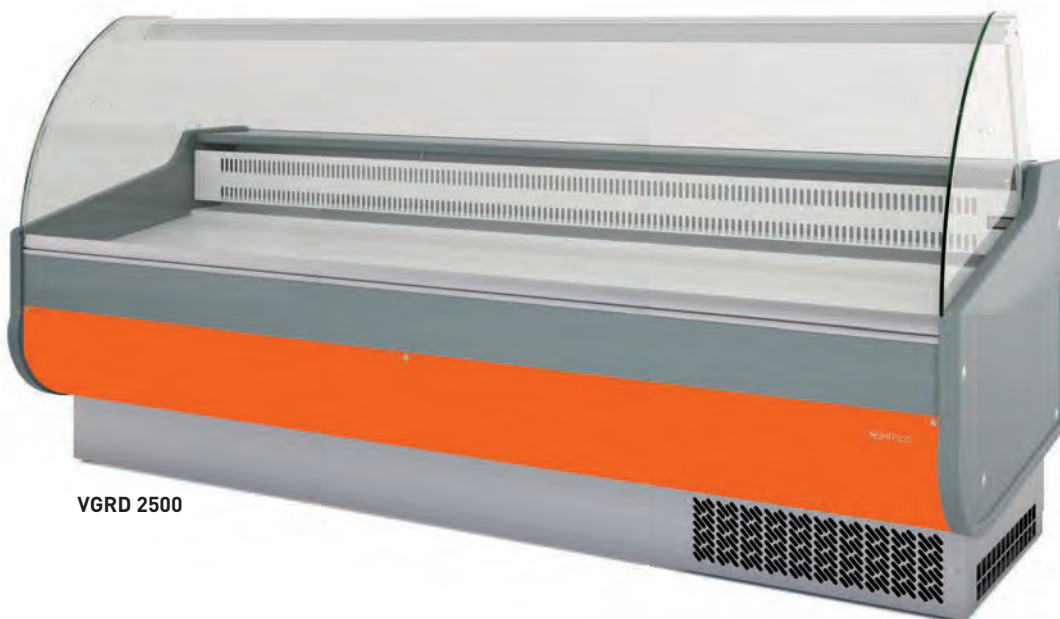

VGRD 2500

OPCIONAL / OPTIONAL

MODELOS MODELS	Puertas correderas traseras Rear sliding doors	Estante Shelf
VGRD 1000	(PUEVGRD10CT) <b>94 €</b>	(ESTLMRGRD10) <b>53 €</b>
VGRD 1500	(PUEVGRD15CT) <b>140 €</b>	(ESTLMRGRD15) <b>74 €</b>
VGRD 2000	(PUEVGRD20CT) <b>190 €</b>	(ESTLMRGRD20) <b>105 €</b>
VGRD 2500	(PUEVGRD25CT) <b>236 €</b>	(ESTLMRGRD25) <b>124 €</b>
VGRD 3000	(PUEVGRD30CT) <b>287 €</b>	(ESTLMRGRD30) <b>147 €</b>



VGRD 1000

1.596 €



VGRD 1500

1.876 €

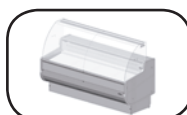

VGRD 2000

2.162 €

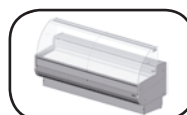

VGRD 2500

2.582 €



VGRD 3000

2.979 €

# 07 VITRINA EXPOSITORA FRÍO VENTILADO CON RESERVA SERIE MARBELLA

## REFRIGERATED WITH STORAGE DISPLAY CASE MARBELLA SERIES



VMB 9 R

1.974 €



VMB 12 R

2.242 €

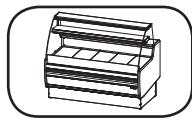

VMB 15 R

2.474 €

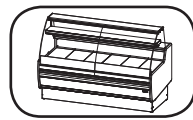

VMB 18 R

2.878 €

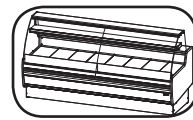

VMB 25 R

3.371 €



VMB 15 R



VMB 15 R

### EXTERIOR

- Chapa de acero plastificada
- Cristal curvo securizado (R)
- Cristal recto securizado (RP)
- Bancada en acero esmaltado
- Claro de puerta de acceso media reserva 445x265

### INTERIOR

- Chapa de acero plastificada
- Plano de exposición en acero esmaltado
- Iluminación LED plano de exposición

### AISLAMIENTO

- Poliuretano inyectado alta presión libre de CFC's densidad 40 kg/m<sup>3</sup>, bajo GWP y cero efecto ODP

### REFRIGERACIÓN

- Sistema de condensación ventilada
- Control temperatura final del desescarche
- Bandeja evaporativa automática
- Clase climática 4

### EXTERIOR

- Laminated steel plate
- Curved tempered security glass system (R)
- Flat tempered security glass system (RP)
- Enamelled steel base
- Storage door opening 445x265

### INTERIOR

- Laminated steel plate
- Enamelled exhibition steel surface
- Upper profile LED lighting for exhibition surface

### INSULATION

- Free CFC's high density (40kg/m<sup>3</sup>) polyurethane insulation with low GWP & zero ODP effect

### REFRIGERATION

- Forced air refrigeration system
- Control of the final defrost temperature
- Automatic evaporative tray
- Climatic class 4

MODELOS MODELS	→	↗	↑	⏻	⚡	📦	📱	📺	☰	🔧	🛒	💧	🌡️	❄️	🔧	📺	🌡️
	Dimensiones sin costados Dimensions without sides LxPxH (mm)	Costados Sides (2)(mm)	Potencia Power (W)	Electrica Electrical (W/Hz)	Capacidad Capacity (L)	Puertas Doors	Superficie exposición (m <sup>2</sup> )	Estantes Shelving	Compresor Compressor (HP)	Consumo Consumption (kWh/24h)	Evaporación Evaporation	Régimen T <sup>RA</sup> 30°C/55% H.R	Potencia frigorífica Refrigerating power (W a -10°C)	Desescarche Defrost	Control Control	Refrigerante Refrigerant	
VMB 9 R VMB 9 RP	938x953x1300/1315	30+30	700	220/50	103	1	0,62	1	1/2	9,8	Forzada Forced	0°C/+6°C	545	Automático Automatic	Digital	R 404 A	
VMB 12 R VMB 12 RP	1250x953x1300/1315	30+30	950	220/50	138	2	0,83	1	5/8	13,3	Forzada Forced	0°C/+6°C	676	Automático Automatic	Digital	R 404 A	
VMB 15 R VMB 15 RP	1562x953x1300/1315	30+30	1000	220/50	172	2	1,03	1	3/4	14,0	Forzada Forced	0°C/+6°C	1096	Automático Automatic	Digital	R 404 A	
VMB 18 R VMB 18 RP	1875x953x1300/1315	30+30	1230	220/50	206	3	1,24	1	1	17,2	Forzada Forced	0°C/+6°C	1315	Automático Automatic	Digital	R 404 A	
VMB 25 R VMB 25 RP	2500x953x1300/1315	30+30	1460	220/50	275	4	1,65	1	1+1/6	20,4	Forzada Forced	0°C/+6°C	1506	Automático Automatic	Digital	R 404 A	

Características técnicas y constructivas sujetas a variación sin previo aviso / We reserve the right to change specifications without prior notice.

**VITRINA EXPOSITORA FRÍO VENTILADO CON RESERVA SERIE MARBELLA**  
REFRIGERATED WITH STORAGE DISPLAY CASE MARBELLA SERIES

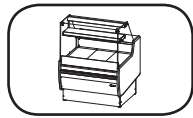

VMB 9 RP

1.997 €

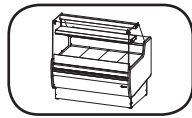

VMB 12 RP

2.263 €

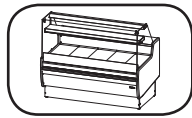

VMB 15 RP

2.505 €

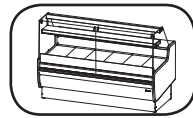

VMB 18 RP

2.876 €

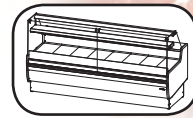

VMB 25 RP

3.368 €



VMB 9 RP

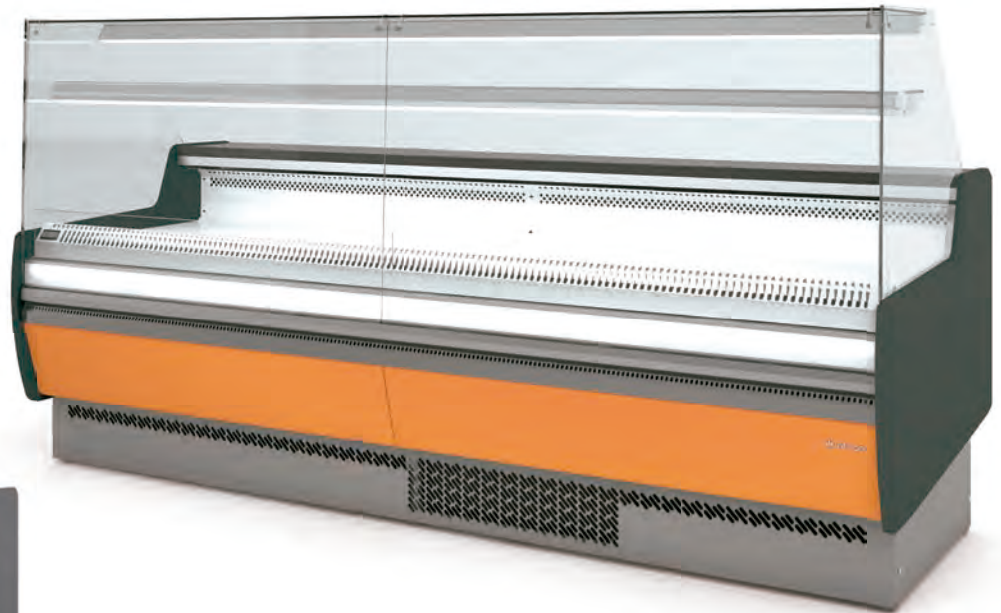

VMB 25 RP

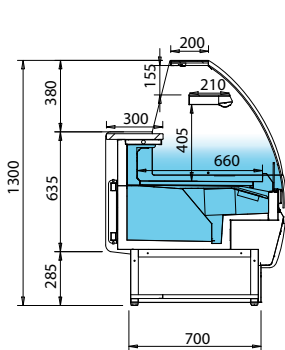

VMB R

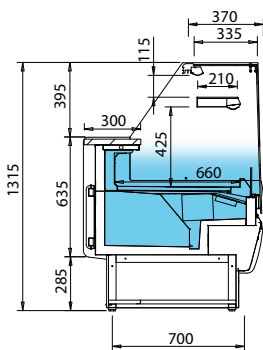

VMB RP

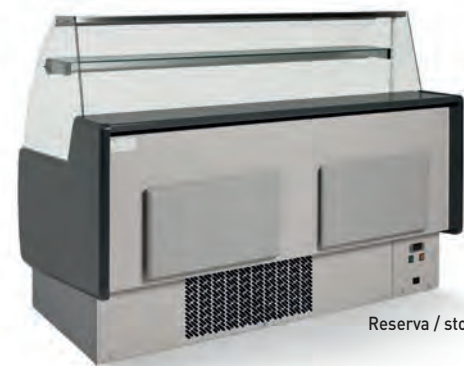

Reserva / storage

**OPCIONAL / OPTIONAL**

MODELOS MODELS	Puertas correderas traseras Rear sliding doors	Luz LED decoración frontal Frontal decoration LED lighting	Luz LED estante LED lighting shelf
VMB 9	(PUEVMB9CT) <b>92 €</b>	(ILUDECVMBC9) <b>47 €</b>	(ILUESTVMBC9) <b>47 €</b>
VMB 12	(PUEVMB12CT) <b>137 €</b>	(ILUDECVMBC12) <b>63 €</b>	(ILUESTVMBC12) <b>63 €</b>
VMB 15	(PUEVMB15CT) <b>185 €</b>	(ILUDECVMBC15) <b>78 €</b>	(ILUESTVMBC15) <b>78 €</b>
VMB 18	(PUEVMB18CT) <b>230 €</b>	(ILUDECVMBC18) <b>94 €</b>	(ILUESTVMBC18) <b>94 €</b>
VMB 25	(PUEVMB25CT) <b>280 €</b>	(ILUDECVMBC25) <b>125 €</b>	(ILUESTVMBC25) <b>125 €</b>

## CARACTERÍSTICAS TÉCNICAS

- Encimera de trabajo y apoya bolsos en polilaminado estratificado
- Bancada en acero esmaltado
- Decoración en chapa plastificada
- Cuerpo y estantes traseros en madera estratificada blanca
- Franja iluminada con LED en la decoración frontal (opcional)

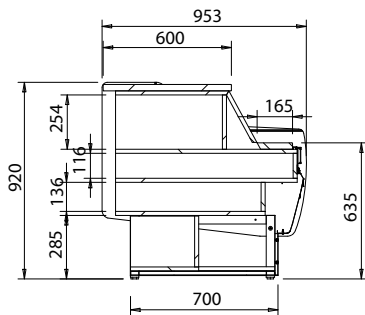

## TECHNICAL FEATURES

- Stratified poly laminate worktop
- Base of enameled steel tube
- Laminated plate decoration
- Structure and rear shelf white laminat wood
- LED lighting frontal decoration (optional)



VMB 9 C

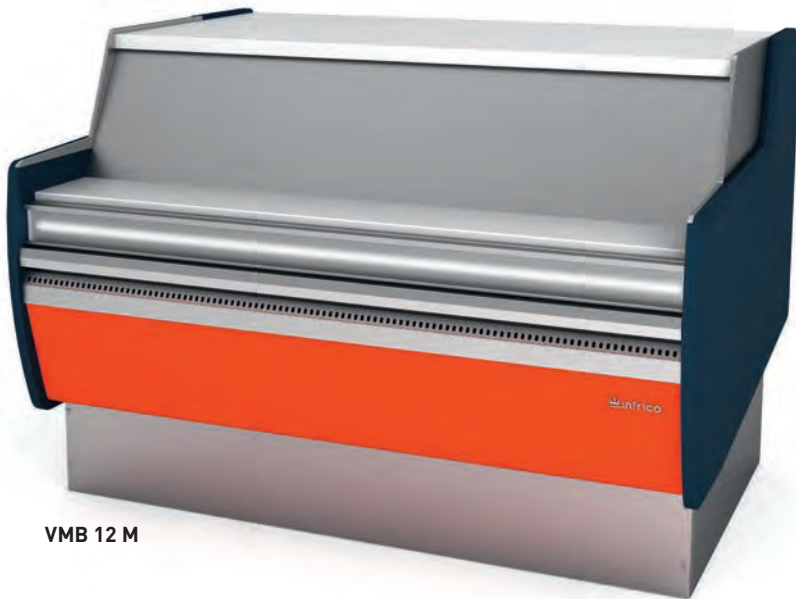

VMB 12 M

MODELOS MODELS	→ ↗ ↑ Dimensiones sin costados Dimensions without sides LxExH (mm)	↖ ↘ Costados Sides (2)(mm)	⏻ Potencia Power (W)	⚡ Electrica Electrical (V/Hz)	📏 Superficie exposición (m <sup>2</sup> )
VMB 9 C	938x953x920	30+30	5	220/50	0,55
VMB 12 M	1250x953x920	30+30	6	220/50	0,74
VMB 15 M	1562x953x920	30+30	7	220/50	0,92

Características técnicas y constructivas sujetas a variación sin previo aviso /  
We reserve the right to change specifications without prior notice.

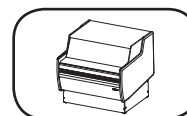

VMB 9 C

1.031 €

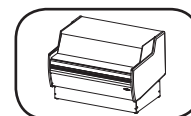

VMB 12 M

1.065 €

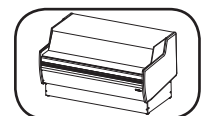

VMB 15 M

1.195 €



DECORACIÓN CHAPA PLASTIFICADA FRONTAL · FRONTAL LAMINATED PLATE DECORATION



DECORACIÓN LACADA · LACQUED DECORATION



07 V. expositoras

ACABADOS POR MÓDULO ENDED BY UNIT	PLASTIFICADO FRONTAL FRONTAL LAMINATED PLATE	LACADO FRONTAL + COSTADOS FRONTAL LACQUED + SIDES	LACADO TOTAL TOTAL LACQUED
VMB 9	Standar	(DFCVMB9) 150 €	(DFTVMB9) 200 €
VMB 12	Standar	(DFCVMB12) 170 €	(DFTVMB12) 220 €
VMB 15	Standar	(DFCVMB15) 200 €	(DFTVMB15) 240 €
VMB 18	Standar	(DFCVMB18) 230 €	(DFTVMB18) 260 €
VMB 25	Standar	(DFCVMB25) 280 €	(DFTVMB25) 300 €

# 07 VITRINA EXPOSITORA FRÍO VENTILADO CON RESERVA SERIE MALLORCA

## REFRIGERATED WITH STORAGE DISPLAY CASE MALLORCA SERIES

### EXTERIOR

- Chapa de acero plastificada
- Cristal curvo securizado
- Bancada en acero esmaltado
- Claro de puerta de acceso media reserva 425x255

### INTERIOR

- Chapa de acero plastificada
- Plano de exposición en acero esmaltado
- Iluminación LED plano de exposición 

### AISLAMIENTO

- Poliuretano inyectado alta presión libre de CFC's densidad 40 kg/m<sup>3</sup>, bajo GWP y cero efecto ODP

### REFRIGERACIÓN

- Sistema de condensación ventilada
- Control temperatura final del desescarche
- Bandeja evaporativa automática
- Clase climática 4

### EXTERIOR

- Laminated steel plate
- Curved tempered security glass system
- Enamelled steel base
- Storage door opening 425x255

### INTERIOR

- Laminated steel plate
- Enamelled exhibition steel surface
- Upper profile LED lighting for exhibition surface 

### INSULATION

- Free CFC's high density (40kg/m<sup>3</sup>) polyurethane insulation with low GWP & zero ODP effect

### REFRIGERATION

- Forced air refrigeration system
- Control of the final defrost temperature
- Automatic evaporative tray
- Climatic class 4

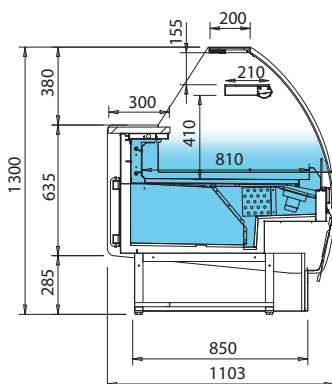

VMC



Reserva / storage

MODELOS MODELS	→	↗	↑	⏻	⚡	📦	🚪	📺	☰	🔧	🛒	🌊	🌡️	❄️	🗑️	🕒	🌡️
	Dimensiones sin costados Dimensions without sides LxPxH (mm)	Costados Sides (2)(mm)	Potencia Power (W)	Electrica Electrical (W/Hz)	Capacidad Capacity (L)	Puertas Doors	Superficie exposición (m <sup>2</sup> )	Estantes Shelving	Compresor Compressor (HP)	Consumo Consumption (kW/24h)	Evaporación Evaporation	Régimen TR <sup>A</sup> 30°C/55% H.R	Potencia frigorífica Refrigerating power (W <sub>3</sub> -10°C)	Desescarche Defrost	Control Control	Refrigerante Refrigerant	
VMC 9 R	938x1103x1300	30+30	730	220/50	131	1	0,76	1	1/2	10,2	Forzada Forced	0°C/+6°C	545	Automático Automatic	Digital	R 404 A	
VMC 12 R	1250x1103x1300	30+30	980	220/50	175	2	1,01	1	5/8	13,7	Forzada Forced	0°C/+6°C	676	Automático Automatic	Digital	R 404 A	
VMC 15 R	1562x1103x1300	30+30	1030	220/50	219	2	1,27	1	3/4	14,4	Forzada Forced	0°C/+6°C	1096	Automático Automatic	Digital	R 404 A	
VMC 18 R	1875x1103x1300	30+30	1260	220/50	263	3	1,52	1	1	17,6	Forzada Forced	0°C/+6°C	1315	Automático Automatic	Digital	R 404 A	
VMC 25 R	2500x1103x1300	30+30	1520	220/50	350	4	2,03	1	1+1/6	21,3	Forzada Forced	0°C/+6°C	1506	Automático Automatic	Digital	R 404 A	

Características técnicas y constructivas sujetas a variación sin previo aviso / We reserve the right to change specifications without prior notice.

**VITRINA EXPOSITORA FRÍO VENTILADO CON RESERVA SERIE MALLORCA**  
 REFRIGERATED WITH STORAGE DISPLAY CASE MALLORCA SERIES



VMC 9 R

2.126 €

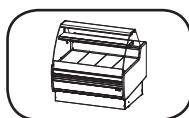

VMC 12 R

2.365 €



VMC 15 R

2.688 €

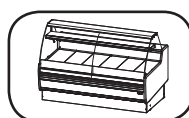

VMC 18 R

2.963 €

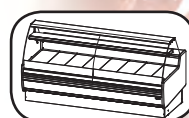

VMC 25 R

3.474 €



VMC 12 R

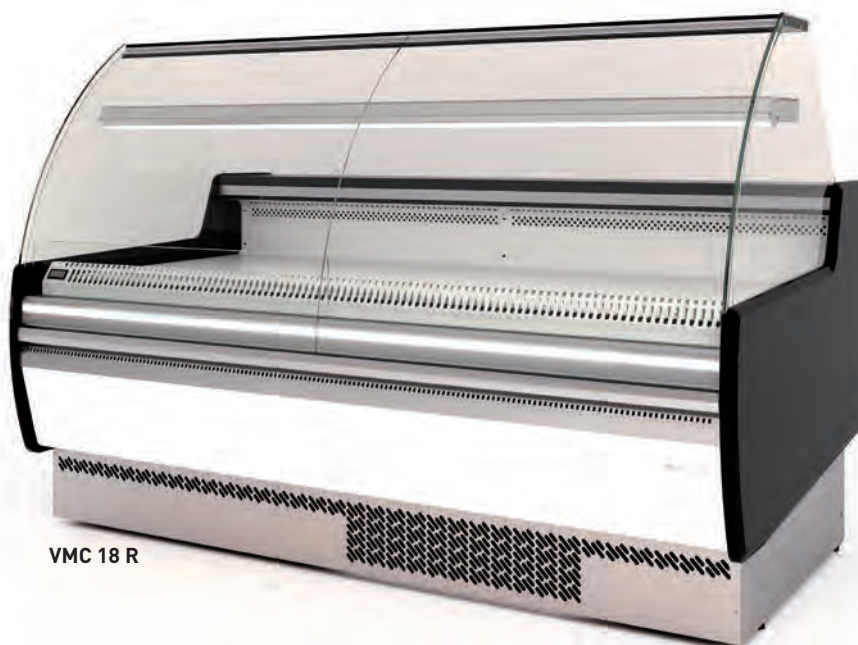

VMC 18 R

**OPCIONAL / OPTIONAL**

MODELOS MODELS	Puertas correderas traseras Rear sliding doors	Luz LED decoración frontal Frontal decoration LED lighting	Luz LED estante LED lighting shelf
VMC 9	(PUEVMC9CT) <b>92 €</b>	(ILUDECVMBC9) <b>47 €</b>	(ILUESTVMBC9) <b>47 €</b>
VMC 12	(PUEVMC12CT) <b>137 €</b>	(ILUDECVMBC12) <b>63 €</b>	(ILUESTVMBC12) <b>63 €</b>
VMC 15	(PUEVMC15CT) <b>185 €</b>	(ILUDECVMBC15) <b>78 €</b>	(ILUESTVMBC15) <b>78 €</b>
VMC 18	(PUEVMC18CT) <b>230 €</b>	(ILUDECVMBC18) <b>94 €</b>	(ILUESTVMBC18) <b>94 €</b>
VMC 25	(PUEVMC25CT) <b>280 €</b>	(ILUDECVMBC25) <b>125 €</b>	(ILUESTVMBC25) <b>125 €</b>

### CARACTERÍSTICAS TÉCNICAS

- Encimera de trabajo y apoya bolsos en polilaminado estratificado
- Bancada en acero esmaltado
- Decoración en chapa plastificada
- Cuerpo y estantes traseros en madera estratificada blanca
- Franja iluminada con LED en la decoración frontal (opcional)

### TECHNICAL FEATURES

- Stratified poly laminate worktop
- Base of enameled steel tubo
- Laminated plate decoration
- Structure and rear shelf white laminat wood
- LED lighting frontal decoration (optional)

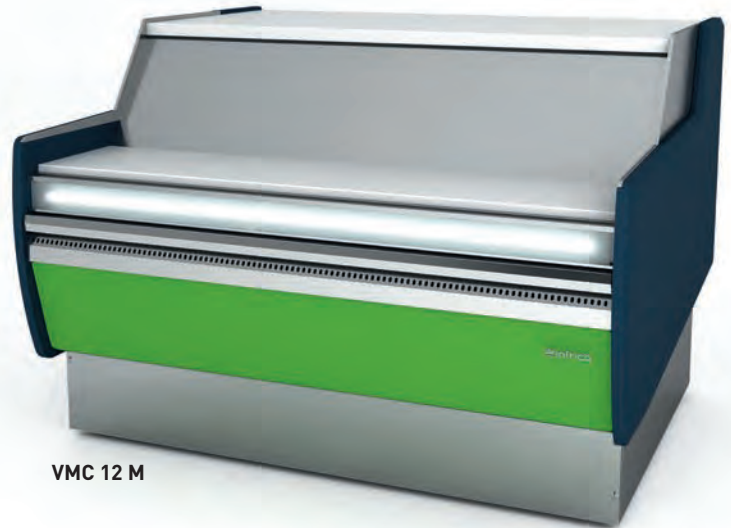
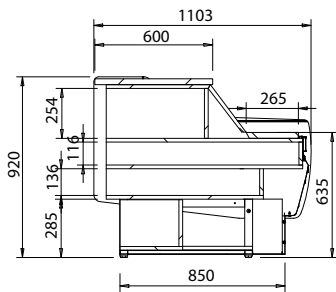

VMC 12 M



VMC 15 M

07 V. expositoras

MODELOS MODELS	→ ↗ ↑ Dimensiones sin costados Dimensions without sides LxFxH (mm)	↖ ↘ Costados Sides (2)(mm)	⏻ Potencia Power (W)	⚡ Electrica Electrical (V/Hz)	📏 Superficie exposición (m <sup>2</sup> )
VMC 9 C	938x1103x920	30+30	5	220/50	0,55
VMC 12 M	1250x1103x920	30+30	6	220/50	0,74
VMC 15 M	1562x1103x920	30+30	7	220/50	0,92

Características técnicas y constructivas sujetas a variación sin previo aviso / We reserve the right to change specifications without prior notice.

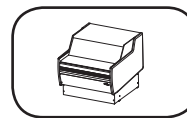

VMC 9 C

1.075 €

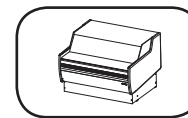

VMC 12 M

1.111 €

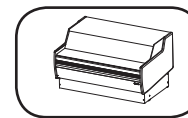

VMC 15 M

1.223 €



DECORACIÓN CHAPA PLASTIFICADA FRONTAL · FRONTAL LAMINATED PLATE DECORATION

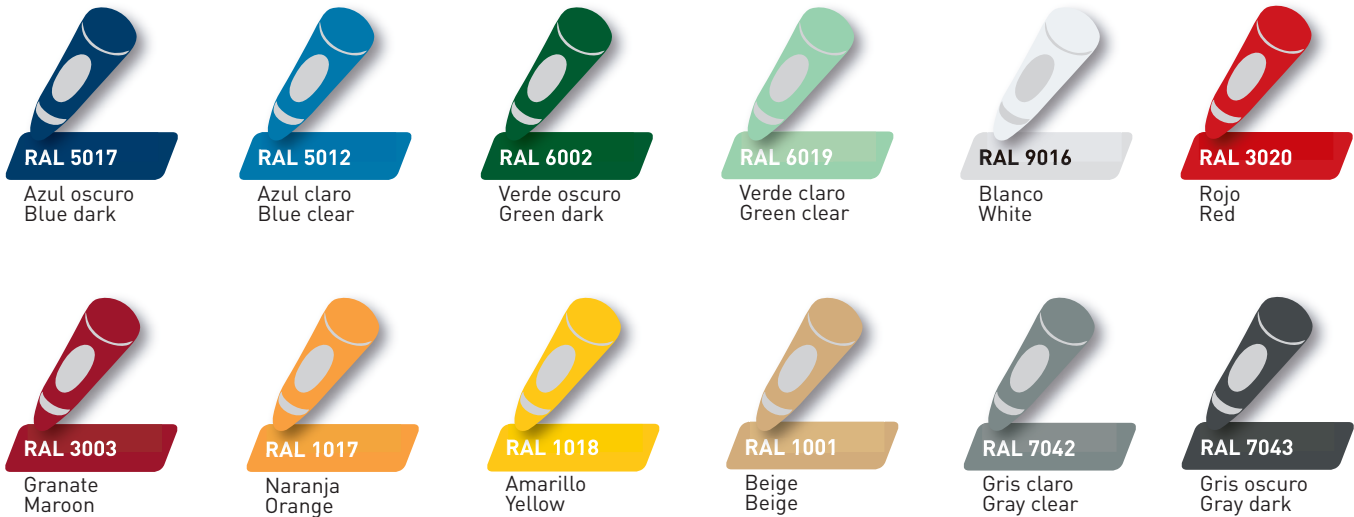

DECORACIÓN LACADA · LACQUED DECORATION



07 V. expositoras

ACABADOS POR MÓDULO ENDED BY UNIT	PLASTIFICADO FRONTAL FRONTAL LAMINATED PLATE	LACADO FRONTAL + COSTADOS FRONTAL LACQUED + SIDES	LACADO TOTAL TOTAL LACQUED
VMC 9	Standar	(DFCVBC9) 150 €	(DFTVMC9) 200 €
VMC 12	Standar	(DFCVBC12) 170 €	(DFTVMC12) 220 €
VMC 15	Standar	(DFCVBC15) 200 €	(DFTVMC15) 240 €
VMC 18	Standar	(DFCVBC18) 230 €	(DFTVMC18) 260 €
VMC 25	Standar	(DFCVBC25) 280 €	(DFTVMC25) 300 €