

# VEG Elegance

**Semimural plug in R-290 de refrigeración abierta, estética vitrina**  
 Closed plug in refrigeration low multideck, aesthetically display case  
 Semi murale de réfrigération R-290 groupe incorporé, esthétique vitrine

1075



VEG18



VEG15

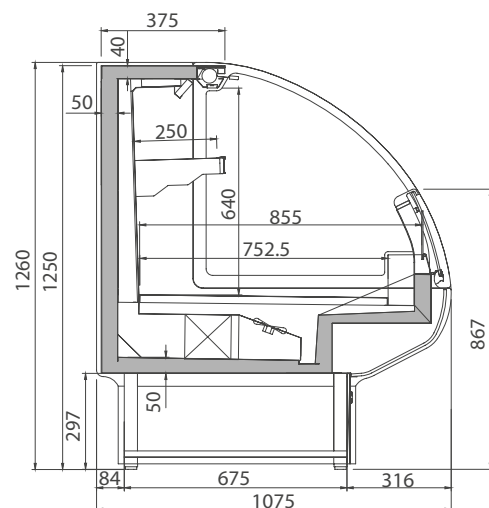

VEG



10

350

Valido para todo el catálogo / Valid for the entire product guide / Valable pour tout le catalogue.  
 Fotografías no contractuales / Photos non contractuelles.  
 Descripciones técnicas y constructivas sujetas a variación sin previo aviso / We reserve the right to change specifications without prior notice / Les caractéristiques techniques et constructives peuvent être sujettes à modifications, sans préavis.

**Serie / Series / Série VEG (ELEGANCE)**

MODELO MODELE MODÈLE				
MOD.	VEG9IU	VEG12IU	VEG15IU	VEG18IU
Medidas Measures Mesures (mm)	938 x 1075 x 1260 mm.	1250 x 1075 x 1260 mm.	1562 x 1075 x 1260 mm.	1875 x 1075 x 1260 mm.
T°. Prod.   Aplic. Prod. T°.   Applic. T°. (°C) Temp. Prod.   Temp. Appliq.	<b>M2: -1/+7°C   +2/+4°C</b>			
Clase Climática Climatic class Classe climatique (°C)	3 / 25°C			
Tensión/Frecuencia Electrical data Tension électrique	230V/1ph/50Hz			
Controlador Controller Régulateur	Digital			
Material Material Matériel (EXT/INT)	Ext/Int: Acero galvanizado plastificado / Plastified galvanised steel / Acier galvanisé plastifié Int: Inox AISI 304 (mod. I)			
Aislamiento Isolation Isolation	40kg/m <sup>3</sup> / Free CFC's / Zero ODP-GWP			
Capacidad Capacity Capacité (L)	316	425	531	638
Superficie exposición Surface exhibition Surface d'exposition (x m <sup>2</sup> )	0,83	1,12	1,39	1,67
Compresor Compressor Compresseur (HP)	3/4	3/4	1	1+1/4
Estantes Shelving Étagères	-			
Costados [2] Sides [2] Joues [2] (mm)	30+30			
Sistema de frío Cooling System Système de froid	Ventilado / Ventilated / Ventilé			
Desescarche Defrost Dégivrage	Automático / Automatic / Automatique			
Evaporación Evaporation Évaporation	Forzada / Forced / Ventilé			
Potencia Power Puissance (W)	595	741	838	1229
Potencia frig. Cooling capacity Puissance Frig. (W A -10°C)	-			
Consumo Consumption Consommation (kWh/ 24h)	7,85	9,8	11,1	14,8
Refrigerante Refrigerant Gaz	<b>R-290</b>			
Colores estándar Standar colors Couleurs standard	<b>Laterales / Sides / Joues</b> No Incluidos / Not includes / Non incluses Int. Estándar / Standar / Standard Blanco/White/Blanc Negro/Black/Noir Ext. Estándar / Standar / Standard Blanco/White/Blanc Ral 1001 Ral 1018 Ral 2003 Ral 3003 Ral 3020 Design 2108025 Ral 5015 Ral 4007 Ral 6002 Design 1107060 Design 3504035 Ral 9006 Ral 7016 Ral 8017 Negro/Black/Noir			
	Laterales disponibles Available sides Joues disponibles	<b>Color lateral y zócalo / Side and plinth colour / Couleur joue et plinthe</b> Gris oscuro/ Dark gray/ Gris foncé		



# 10. Murales

## Multidecks / Murales

Amplio rango dimensional para ofrecer la máxima capacidad.  
 Wide dimensional range for maximum capacity.  
 Une large gamme dimensionnelle pour offrir une capacité maximale.

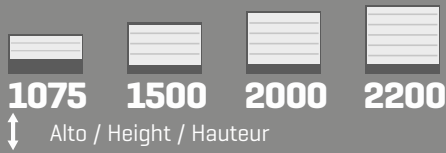
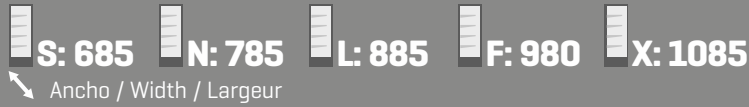
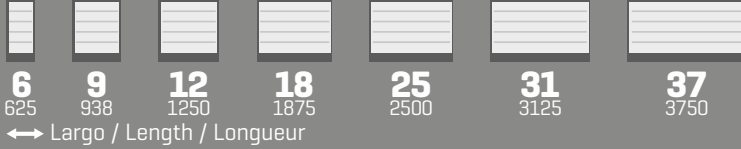

Máxima visibilidad de producto expuesto.  
 Maximum visibility of displayed product.  
 Visibilité maximale du produit exposé.



### Iluminación / Lighting / Éclairage

Incorporación de iluminación LED, llegando a reducir el consumo energético entre un 80% y 90%, respecto a una bombilla tradicional. RGB opcional.

LED lighting incorporated, reducing energetic consumption between 80% and 90% respect to a traditional lighth bulb. RGB optional.

Éclairage LED, réduisant la consommation énergétique entre 80% et 90%, par rapport à une ampoule traditionnelle. RGB optionnel.



Rango completo de temperaturas.  
 Full temperature range.  
 Gamme de température complète.

T° Prod.	T° Aplic.	Icons
M0: -1/+4°C	-1/+1°C	🍷 🍺
M1: -1/+5°C	0/+2°C	🍷 🍺 🥗 🥛
M2: -1/+7°C	+2/+4°C	🍷 🍺 🥗 🥛
H1: +1/+10°C	+4/+6°C	🥛 🥗
L1: -15/-18°C	-23/-25°C	❄️



**Estantes regulables e inclinables optimizados para cada ancho, mejorando la capacidad de carga sin reposiciones.**

Adjustable and tilting shelves optimised for each width, improving load capacity without repositioning.

Des étagères réglables et inclinables optimisées pour chaque largeur, améliorant la capacité de charge sans repositionnement.



**Amplias posibilidades de personalización: amplia gama de colores, laterales, accesorios...**

Extensive customisation possibilities: wide range of colours, sides, accessories...

Possibilités de personnalisation étendues : large gamme de couleurs, de côtés, d'accessoires...



Puertas / Doors / Portes

**SLIM**

**Puerta estándar de gran aislamiento**  
Standard door highly efficient  
Porte standard très isolée

**Cristales dobles templados, carga de Argón 90%, integración total, bisagras oleodinámicas, cierre automático 0-85°.**

Tempered double glass, Argon charge 90%, fully integrated, oleodynamic hinges, automatic closing 0-85°.

Double vitrage trempé, charge d'Argon 90%, intégration totale, charnières oléodynamiques, fermeture automatique 0-85°.

Puertas / Doors / Portes

**TOTAL LOOK**

**Cristal doble completamente transparente**  
Fully transparent double glass door  
Porte en verre double entièrement transparente

**Cristales dobles templados, carga de Argón 90%, integración total, bisagras oleodinámicas, cierre automático 0-85°.**

Tempered double glass, Argon charge 90%, fully integrated, oleodynamic hinges, automatic closing 0-85°.













Double vitrage trempé, charge d'Argon 90%, intégration totale, charnières oléodynamiques, fermeture automatique 0-85°.



# 10. Murales

## Multidecks / Murales

Régimen de temperaturas / Temperature range / Régime de températures (ISO23953)

<p>Tª Prod.   Tª Aplic.  <b>M0: -1/+4°C   -1/+1°C</b>   Carne / Meat / Viande   Pescado / Fish / Poisson</p>	<p>Tª Prod.   Tª Aplic.  <b>M1: -1/+5°C   0/+2°C</b>   Carne / Meat / Viande   Pescado / Fish / Poisson   4ª Gama / 4TH Range / 4ème Gamme   Comida preparada / Grab &amp; Go / Plats préparés</p>	<p>Tª Prod.   Tª Aplic.  <b>M2: -1/+7°C   +2/+4°C</b>   Charcutería / Deli / Charcuterie   Bebidas / Cold drinks / Boissons   Lacteos / Dairy / Laitiers</p>
<p>Tª Prod.   Tª Aplic.  <b>H1: +1/+10°C   +4/+6°C</b>   Lacteos / Dairy / Laitiers   Frutas y verduras / Fruit vegetables / Fruits et légumes</p>	<p>Tª Prod.   Tª Aplic.  <b>L1: -15/-18°C   -23/-25°C</b>   Congelados / Frozen foods / Produits surgelés</p>	

### WATERIN

Waterin son muebles de refrigeración comercial para la conservación de productos refrigerados y congelados, con unidades individuales eco R290 y sistema de condensación por agua que cumplen con el reglamento F-GAS.

Waterin are commercial refrigeration display cases for the preservation of refrigerated and frozen products, with individual R290 eco units and water condensation system complying with F-GAS regulations.

Les meubles Waterin sont un mobilier frigorifiques commerciales conçues pour la conservation des produits réfrigérés et surgelés. Ils intègrent des unités individuelles eco R290 et un système de condensation à eau, conformes à la réglementation F-GAS.

