











Vitrina expositora frío ventilado / Refrigerated whit storage display case / Vitrine de présentation non canalisable

MODELO MODELE MODÈLE	CRISTAL CURVO / CURVED GLASS / VITRE BOMBÉE				
	 VMB 9 RU/RIU	 VMB 12 RU/RIU	 VMB 15 RU/RIU	 VMB 18 RU/RIU	 VMB 25 RU/RIU
Medidas Measures Mesures (mm)	998 x 953 x 1300 mm.	1310 x 953 x 1300 mm.	1622 x 953 x 1300 mm.	1935 x 953 x 1300 mm.	2560 x 953 x 1300 mm.
MODELO MODELE MODÈLE	CRISTAL RECTO / FLAT GLASS / VITRE DROITE				
	 VMB 9 RUP/RIUP	 VMB 12 RUP/RIUP	 VMB 15 RUP/RIUP	 VMB 18 RUP/RIUP	 VMB 25 RUP/RIUP
Medidas Measures Mesures (mm)	998 x 953 x 1315 mm.	1310 x 953 x 1315 mm.	1622 x 953 x 1315 mm.	1935 x 953 x 1315 mm.	2560 x 953 x 1315 mm.
Temperatura Temperature Température (°C)	0°C/+6°C				
Clase Climática Climatic class Classe climatique (°C)	4 / 38°C				
Tensión/Frecuencia Electrical data Tension électrique	230V/1ph/50Hz				
Controlador Controller Régulateur	Digital				
Material Material (EXT/INT) Matériel	Acero plastificado / Plastic-coated steel / Acier plastifié Inox AISI 304				
Costados Sides Joues (mm)	30 + 30				
Aislamiento Isolation Isolation (mm)	40kg/m ³ / Free CFC's / Zero ODP-GWP				
Capacidad Capacity Capacité (L)	144	191	239	287	382
Superficie exposición Surface exhibition Surface d'exposition (m ²)	0,66	1,08	1,35	1,63	2,18
Compresor Compressor Compresseur (HP)	1/3	3/8	5/8	3/4	1
Sistema de frío Cooling System Système de froid	Ventilado / Ventilated / Ventilé				
Desescarche Defrost Dégivrage	Automático / Automatic / Automatique				
Expansión Expansion Expansion	Ventilado / Ventilated / Ventilé				
Potencia Power Puissance (W)	380	384	523	573	670
Potencia frig. Cooling capacity Puissance Frig. (W A -10°C)	-				
Consumo Consumption Consommation (kWh/ 24h)	5,9	6,1	7,6	8,3	9,7
Refrigerante Refrigerant Gaz	R-290a				
Opcional Optional Options	Puertas correderas traseras / Rear sliding doors / Portes coulissantes arrière Luz LED deco. frontal / Frontal deco. LED lighting / Éclair. LED deco. frontale				

Serie / Series / Série **MARBELLA**

+Info: www.infrico.com

VMB 15 RU

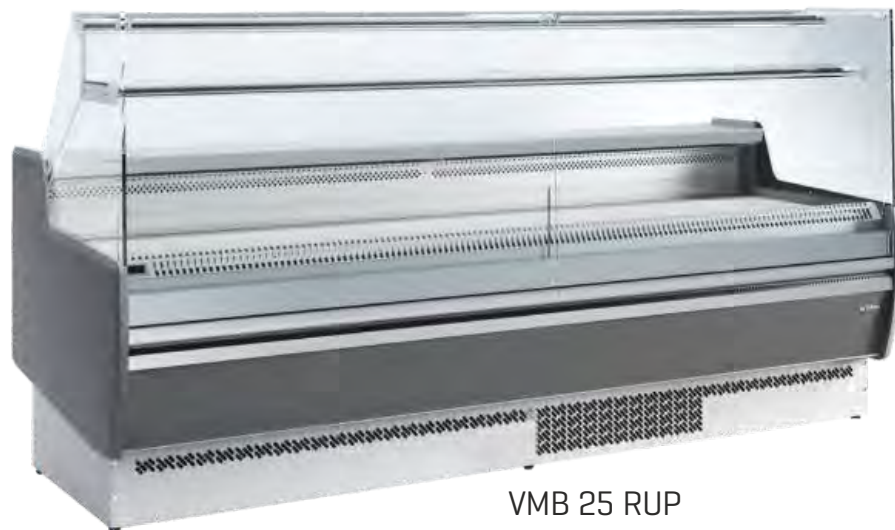

Ext. Estándar / Standar / Standard

Blanco/White/ Blanc	Ral 1001	Ral 1018
Ral 3003	Ral 3020	Ral 2003
Ral 5015	Ral 5017	Ral 5011
Ral 6002	Ral 6018	Ral 6019
Ral 7035	Ral 7037	Ral 7042
Ral 7016	Ral 9006	Negro/Black/ Noir

VMB 25 RUP

Colores fuera de carta /
Colors outside of letter /
Couleurs spéciales, hors palette

RAL		NO RAL	
Epoxi	Líquida/ Liquid/ Liquide	Epoxi	Líquida/ Liquid/ Liquide
849 €	527 €	Consultar / Consultar / Consulter	
[x unidad/x unit/x unité]			
+10 días laborables / +10 work days / +10 jours ouvrés		Consultar / Consultar / Consulter	

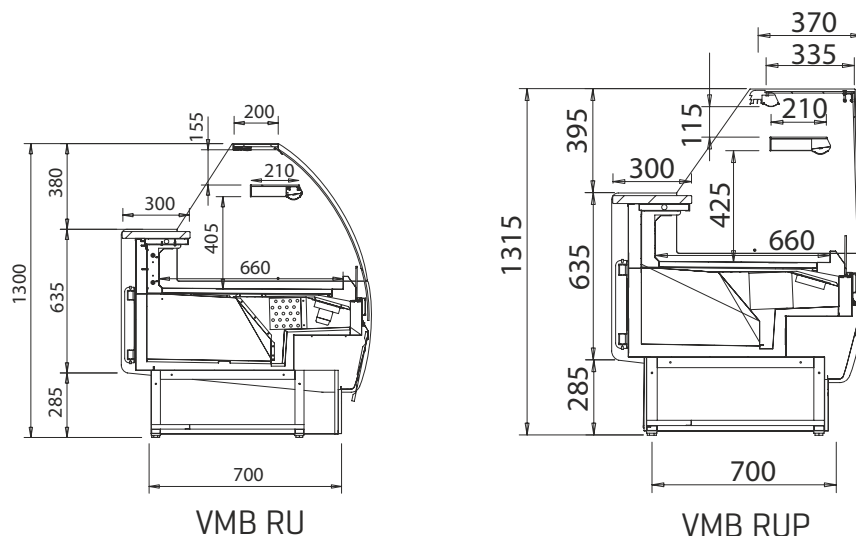

VMB RU

VMB RUP