



01 ENFRIADOR DE TAPAS

HORS D'OEUVRES EXHIBITOR CASE

EXTERIOR

- Perfil de aluminio anodizado
- Cristal curvo abatible (VET)

INTERIOR

- Bandeja de exposición en acero Inox AISI 304 18/10
- Iluminación LED perfil superior 
- Iluminación LED bazar intermedio (D) 

ASLAMIENTO

- Poliuretano inyectado alta presión libre de CFC's densidad 40 kg/m³, bajo GWP y cero efecto ODP



PUERTAS

- Puertas correderas traseras suspendidas

EXTERIOR

- Anodized aluminium profile
- Front open ringl glass (VET)

INTERIOR

- AISI 304 18/10 Stainless steel exhibition tray
- LED lighting upper profile 
- LED lighting in the mid-section (D) 

INSULATION

- Free CFC's high density (40kg/m³) polyurethane insulation with low GWP & zero ODP effect

DOORS

- Suspended sliding rear doors

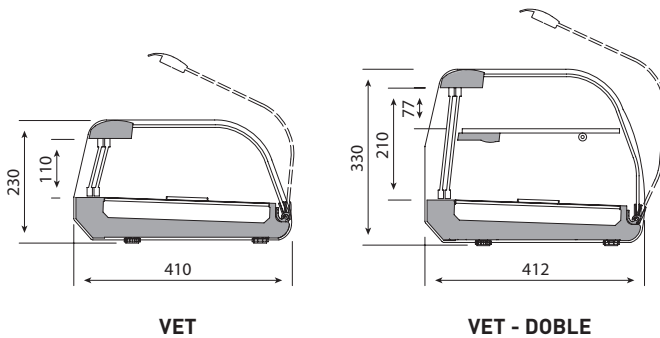

MODELOS MODELS	→ ↑ ↻ ⚡ ⚠	→ ↑ ↻ ⚡ ⚠	→ ↑ ↻ ⚡ ⚠	→ ↑ ↻ ⚡ ⚠	→ ↑ ↻ ⚡ ⚠	→ ↑ ↻ ⚡ ⚠	→ ↑ ↻ ⚡ ⚠	→ ↑ ↻ ⚡ ⚠	→ ↑ ↻ ⚡ ⚠	→ ↑ ↻ ⚡ ⚠	→ ↑ ↻ ⚡ ⚠	→ ↑ ↻ ⚡ ⚠	→ ↑ ↻ ⚡ ⚠	→ ↑ ↻ ⚡ ⚠
	Dimensiones Dimensions LxPxA1 (mm)	Potencia Power (W)	Tensión/Frecuencia Electrical (V/Hz)	Capacidad Capacity (L)	Superficie exposición (m ²)	Bandejas G/N Trays G/N 1,2x40	Nº parrillas/A. guías No shelves / Slides	Compresor Compressor (HP)	Potencia Frig. Cooling capacity (W) (1°~10°C)	Evaporación Evaporation	Régimen temperatura Temperature range (2°C)	Desescarche Defrost	Control Control	Refrigerante Coolant
VET 4 P	1268x410x230	130	220/50	9,2	0,23	4		1/6	140	Placa fría Cold board	+4°C/+8°C	Manual Manual	Digital	R 134 a
VET 6 P	1620x410x230	190	220/50	13,6	0,34	6		1/6	140	Placa fría Cold board	+4°C/+8°C	Manual Manual	Digital	R 134 a
VET 8 P	1972x410x230	200	220/50	18,4	0,46	8		1/6	140	Placa fría Cold board	+4°C/+8°C	Manual Manual	Digital	R 134 a
VET 4 DP	1268x412x330	135	220/50	9,2	0,23	4	1 (LED)	1/6	140	Placa fría Cold board	+4°C/+8°C	Manual Manual	Digital	R 134 a
VET 6 DP	1620x412x330	195	220/50	13,6	0,34	6	1 (LED)	1/6	140	Placa fría Cold board	+4°C/+8°C	Manual Manual	Digital	R 134 a
VET 8 DP	1972x412x330	205	220/50	18,4	0,46	8	1 (LED)	1/6	140	Placa fría Cold board	+4°C/+8°C	Manual Manual	Digital	R 134 a
VET 7 P GR	1338x410x230	200	220/50	16,0	0,40	7		1/6	140	Placa fría Cold board	+4°C/+8°C	Manual Manual	Digital	R 134 a
VET 9 P GR	1690x410x230	210	220/50	20,4	0,51	9		1/6	140	Placa fría Cold board	+4°C/+8°C	Manual Manual	Digital	R 134 a
VET 7 DP GR	1338x412x330	205	220/50	16,0	0,40	7	1 (LED)	1/6	140	Placa fría Cold board	+4°C/+8°C	Manual Manual	Digital	R 134 a
VET 9 DP GR	1690x412x330	215	220/50	20,4	0,51	9	1 (LED)	1/6	140	Placa fría Cold board	+4°C/+8°C	Manual Manual	Digital	R 134 a

Características técnicas y constructivas sujetas a variación sin previo aviso / We reserve the right to change specifications without prior notice.

ENFRIADOR DE TAPAS
HORS D'OEUVRES EXHIBITOR CASE



VET 7 DP GR



VET 6 DP



VET 8 P

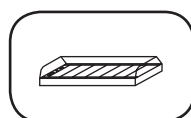

VET 7 P GR

972 €

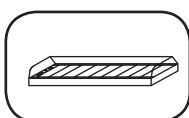

VET 9 P GR

1.099 €

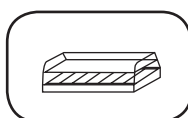

VET 7 DP GR

1.114 €

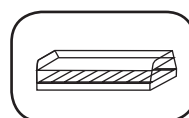

VET 9 DP GR

1.241 €

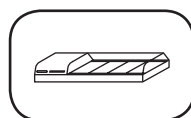

VET 4 P

887 €

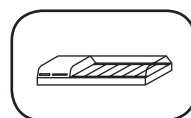

VET 6 P

993 €

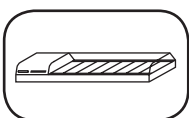

VET 8 P

1.095 €

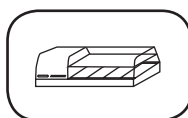

VET 4 DP

1.029 €

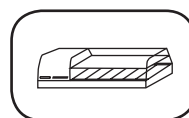

VET 6 DP

1.159 €

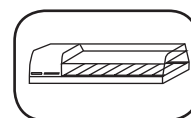

VET 8 DP

1.295 €