

Taquillas de 1, 2 y 3 puertas

1, 2 and 3 doors lockers

Armoire pour vestiaire de 1, 2 et 3 portes



Características:

Construida totalmente en acero inoxidable, acabado satinado. Dispone de techo inclinado y patas en altura de 115 mm para poder limpiar debajo de ella. Estas patas están situadas de manera que salvan la curva sanitaria en la pared. Pies regulables. Ventilación mediante respiraderos embutidos. Cerraduras independientes. Cada cuerpo lleva un entrepaño superior, otro en la base y un perchero.

Characteristics:

Totally made in stainless steel, satin finished, they have inclined roof, legs' high 115 mm. To be able to clean under them, also these legs are situated to save the sanitary curve in walls, regulable feet, ventilation by inlay breathings, and individual locks. Every section has a lower and an upper shelf and a clothes rack.

Caractéristiques:

Fait totalement en acier inox, finition satiné, ils ont le toit incliné, pieds en hauteur de 115 mm. Pour pouvoir nettoyer par dessous d'eux, aussi ces pieds sont situés pour qu'ils sauvent la courbe sanitaire dans le mur, pieds réglables, ventilation par soupirails encastrés, et fermeture indépendante. Chaque section a un évier supérieur et inférieur et un portemanteau.

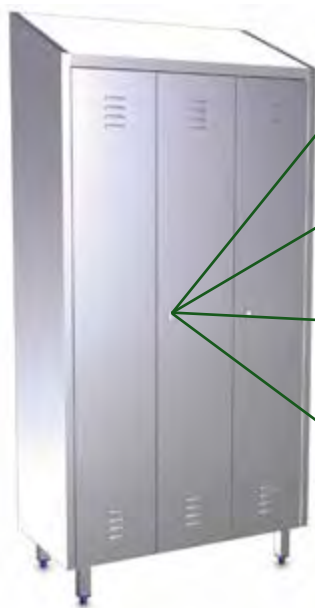

€ 45,00 293

Cerradura de retorno de monedas
Coin operated lock
Serrure à monnaies



481402 3,00 293

Llave maestra para cerraduras.
Master key for locks
Clé passe-partout pour serrures



081612 240,00

Opción de kit de ozono acoplado.
Optional ozone kit coupled
kit ozone acoplé



77,00 294

Cerradura electrónica para taquilla
Electronic lock for lockers
Serrure électronique pour la porte vestiaire

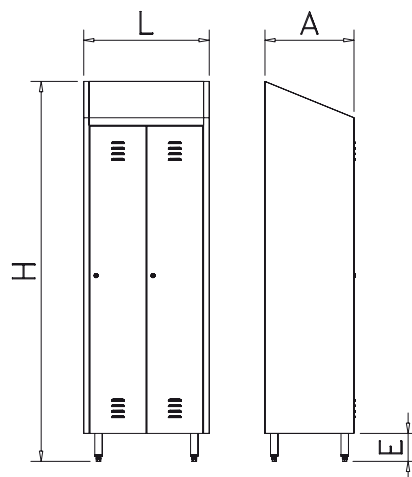

Contienen dos perchas inox por puerta.
Two inox hangers for each door included.
Deux cintres inox inclus par chaque porte.



Posibilidad de acoplar ruedas ver pág 409
Possibility of assembly wheels, see page 409
Possibilité d'accoupler rouelles, voir page 279

L	A	H	E				€
370	480	2.010	115	1	27	081412	650,00
680	480	2.010	115	2	49	081406	980,00
985	480	2.010	115	3	62	081408	1.320,00



Consulten la posibilidad de acoplar un desinfectador-desodorizador por ozono en las taquillas.
Ask for the possibility of assembly a disinfectant-deodorant by ozone in the locker.
Demandez-nous sur la possibilité de accoupler un désinfectant-désodorisant à l'ozone dans l'armoire.

Taquillas de 2, 4 y 6 puertas

2, 4 and 6 doors lockers

Armoire pour vestiaire de 2, 4 et 6 portes

Características:

Construida totalmente en acero inoxidable, acabado satinado. Dispone de techo inclinado y patas en altura de 115 mm para poder limpiar debajo de ella. Estas patas están situadas de manera que salvan la curva sanitaria en la pared. Pies regulables. Ventilación mediante respiraderos embutidos. Cerraduras independientes. Cada cuerpo lleva un entrepaño superior, otro en la base y un perchero.



Characteristics:

Totally made in stainless steel, satin finished, they have inclined roof, legs' high 115 mm. To be able to clean under them, also these legs are situated to save the sanitary curve in walls, regulable feet, ventilation by inlay breathings, and individual locks. Every section has a lower and an upper shelf and a clothes rack.

Caractéristiques:

Fait totalement en acier inox, finition satiné, ils ont le toit incliné, pieds en hauteur de 115 mm. Pour pouvoir nettoyer par dessous d'eux, aussi ces pieds sont situés pour qu'ils sauvent la courbe sanitaire dans le mur, pieds réglables, ventilation par soupirlais encastrés, et fermeture indépendante. Chaque section a un évier supérieur et inférieur et un portemanteau.



€ 45,00 293

Cerradura de retorno de monedas
Coin operated lock
Serrure à monnaie



481402 3,00 293

Llave maestra para cerraduras.
Master key for locks
Clé passe-partout pour serrures



081612 240,00

Opción de kit de ozono acoplado.
Optional ozone kit coupled
kit ozone accouplé

€ 77,00 294

Cerradura electrónica para taquilla
Electronic lock for lockers
Serrure électronique pour la porte vestiaire



Posibilidad de acoplar ruedas ver pág 409
Possibility of assembly wheels, see page 409
Possibilité d'accoupler rouelles, voir page 409

L	A	H	E				€
370	480	2.010	115	2	28	081410	785,00
680	480	2.010	115	4	50	081402	1.125,00
985	480	2.010	115	6	68	081404	1.460,00



Contienen dos perchas inox por puerta.
Two inox hangers for each door included.
Deux cintres inox inclus par chaque porte.



Consulten la posibilidad de acoplar un desinfectador-desodorizador por ozono en las taquillas.
Ask for the possibility of assembly a disinfectant-deodorant by ozone in the locker.
Demandez-nous sur la possibilité de accoupler un désinfectant-désodorisant à l'ozone dans l'armoire.

Percha industrial de acero inoxidable

Stainless steel industrial hanger
Cintre industrielle en acier inoxydable



Características:

Totalmente construida en acero inoxidable.
Ideal para gimnasios, piscinas, vestuarios colectivos, lavanderías, etc.
Diseño renovado que permite colgar delantales y prendas con tirantes.

Characteristics:

Wholly made of stainless steel.
Excellent for gymnasiums, swimming pools, dressing-rooms, laundries, etc.
New design that allows to hang up aprons and garments with shoulder straps.

Caractéristiques:

Entièrement construit en acier inoxydable.
Excellente pour gymnases, piscines, établissements de bains, blanchisseries, etc.
Dessin renouvelé qui permet prendre des tabliers et vêtements à épaulettes.

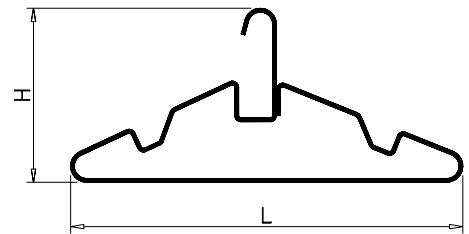

L	H	Gr	Barcode	€
420	190	120	081450	6,00

Separadores para taquillas

Dividers for lockers
Diviseur pour armoire vestiaire



081456

081458

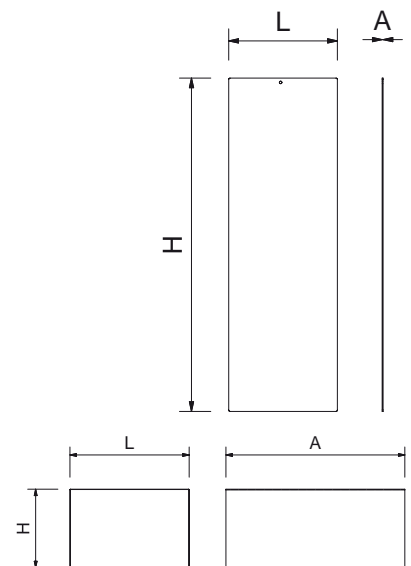

L	A	H	Kg	Barcode	€
450	3	1.180	0,80	081456	16,00
300	450	197	2,03	081458	29,00

Banco vestuario
Changing room bench
Banc pour vestiaire



Características:

Estructura de acero inoxidable.
Asiento de fenólico en lamas color azul.
Cantos redondeados.
Tornillos ocultos en inoxidable.

Characteristics:

Structure manufactured in stainless steel.
Seat of phenol lames of blue colour.
Rounded edge.
Hidden screws in stainless steel.

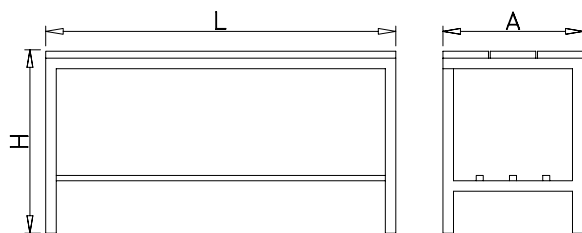

Caractéristiques:

Structure construit en acier inoxydable.
Siège en phénol de lames couleur bleu.
Rebord ronde.
Vis occultes en acier inoxydable.

L	A	H	Kg	Barcode	€
1.000	340	480	12,0	481602	425,00
1.500	340	480	18,0	481604	537,00

Banco inoxidable de vestuario con doble zapatero

Stainless bench for changing room with double shoe rack
Banc range chaussures inoxydable de vestiaire 2 niveaux

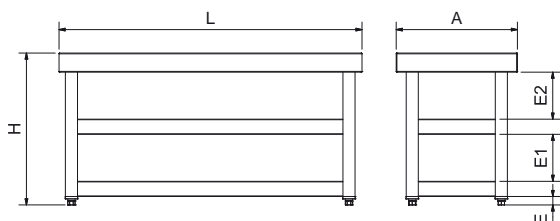

L	A	H	E	E1	E2	Kg	Barcode	€
1.000	400	500	28	155	155	18,7	084202	454,00

Armario para productos de limpieza

Wardrobe for cleaning products

Armoire pour produits d'entretien



Características:

Como dotación estándar lleva tres estantes en el lado derecho para la colocación de trapos, productos de limpieza, etc. Además, su diseño permite guardar cubos, recipientes grandes, escobas, fregonas, etc. Construido totalmente en acero inoxidable, acabado satinado, dispone de techo inclinado y 4 patas en altura de 115 mm para poder limpiar debajo de él. Estas patas están situadas de tal manera que salvan la curva sanitaria en la pared. Pies regulables. Ventilación mediante respiraderos embutidos. Pomo con posibilidad de acoplar candado. Ver página 294.



081612 240,00

Opción de kit de ozono acoplado.

Optional ozone kit coupled
kit ozone accouplé



Set colgador sujeta-palos.

Handle-holder kit.
Kit porte-manches.

386

Opcional / Optional / Optionnel



Characteristics:

As standard equipment it has three shelves within one side for the placing of clothes, cleaning products, etc. At the same time its design allows to put in buckets, big containers, brooms, mops, etc. Made totally in stainless steel, satin finished, posses reclined roof, legs of 115 mm height in order you can clean below. In addition, these legs are designed in such a way that saves the sanitary wall curve and at the same time they are adjustable. Ventilation by means of hammered vents and lock. A padlock can be placed onto the handle, see page 294.

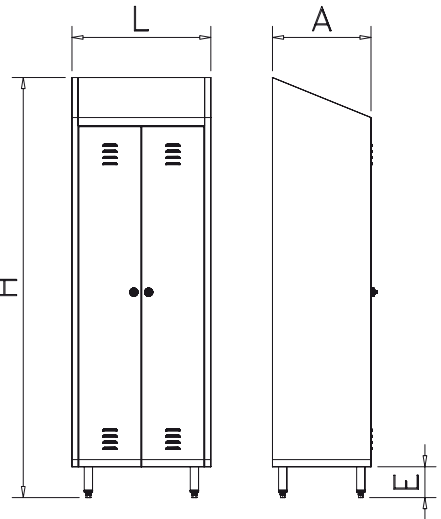

Caractéristiques:

Comme équipement standard il a trois étagères dans une des côtes pour la placement des chiffons, produit d'entretien, etc. En plus, sa dessine permet garder seaux, récipients grands, balais, balais-serpillières, etc. Construit totalement en acier inoxydable, avec finition satiné, ils ont toit penché et empiétements de 115 mm d'hauteur pour qu'on peut nettoyer dessous. Ces empiétements sont dessinées tellement qui sauvent la courbe sanitaire du mur et en même temps sont réglables. Aération par soupiraux emboutis et serrure. On peut placer un cadenas dans le bouton, voir page 294.



L	A	H	E	🕒	Kg	📊	€
370	480	2.010	115	1	27	081412	655,00
680	480	2.010	115	2	45	081602	860,00



Consulten la posibilidad de acoplar un desinfectador-desodorizador por ozono en el armario.

Ask for the possibility of assembly a disinfectant-deodorizant by ozone in the wardrobe
Demandez-nous sur la possibilité de accoupler un désinfectant-désodorisant à l'ozone dans l'armoire

Posibilidad de acoplar ruedas ver pág 408

Possibility of assembly wheels, see page 408
Possibilité d'accoupler rouelles, voir page 408

Armario estantería 2 puertas
2 doors shelving wardrobe
Armoire rayonnage de 2 portes

Características:

Construido totalmente en acero inoxidable, acabado satinado, dispone de techo inclinado y 4 patas en altura de 115 mm para poder limpiar debajo de él. Estas patas están situadas de tal manera que salvan la curva sanitaria en la pared. Pies regulables. Ventilación mediante respiraderos embutidos. Pomo con posibilidad de colocar candado. Ver página 294.



Characteristics:

Made totally in stainless steel, satin finished, posses reclined roof, legs of 115 mm height in order you can clean below. In addition, these legs are designed in such a way that saves the sanitary wall curve and at the same time they are adjustable. Ventilation by means of hammered vents and lock. A padlock can be placed onto the handle, see page 294.

Caractéristiques:

Construit totalement en acier inoxydable, avec finition satiné, ils ont toit penché et empiétements de 115 mm d' haut pour qu' on peut nettoyer dessous. Ces empiétements sont dessinées tellement qui sauvent la courbe sanitaire du mur et en même temps sont réglables. Aération par soupiraux emboutis et serrure. On peut placer un cadenas dans le bouton, voir page 294.



***HASTA 190 Kg**
Up to 190 kgs of load strength
Jusqu' à 190 kgs de résistance



081612 240,00

Opción de kit de ozono acoplado.
Optional ozone kit coupled
kit ozone accouplé



***HASTA 500 Kg**
Up to 500 kgs of load strength
Jusqu' à 500 kgs de résistance

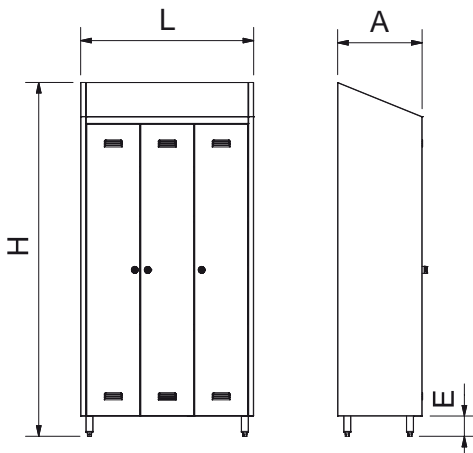

El pomo admite la colocación de candado.
Handle-holder kit.
Kit porte-manches.

294

Op Opcional / Optional / Optionnel



L	A	H	E					€
680	480	2.010	115	2	190	55	081650	1.060,00
980	480	2.010	115	3	500	66	081652	1.479,00



Posibilidad de acoplar ruedas ver pág 408
Possibility of assembly wheels, see page 408
Possibilité d' accoupler rouelles, voir page 408

Armario para equipos informáticos

Wardrobe for computer equipment
Cabinet pour matériel informatique

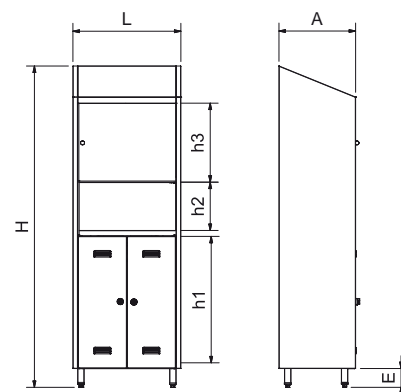

L	A	H	E	h1	h2	h3	Kg	Barcode	€
680	480	2.010	115	795	300	500	52	076402	1.150,00

Consigna para carros con taquilla

Left-trolleys with locker
Consigne pour caddies avec casier

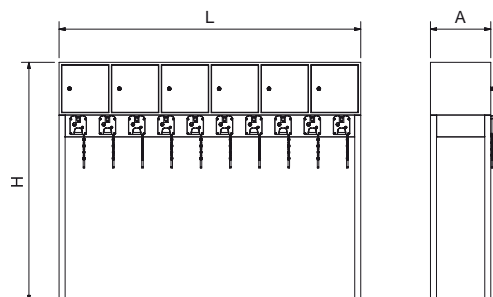

L	A	H	Locker	Kg	Barcode	€
2.000	400	1.590	10	40	081432	1.200,00

Consigna para carros

Left-shopping trolleys
Consigne pour caddies

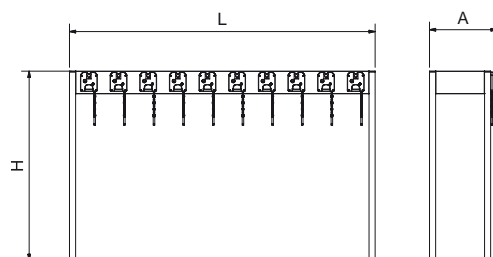

L	A	H	Locker	Kg	Barcode	€
2.000	400	1.240	10	24	081430	725,00

Consigna mural para carros

Wall left-shopping trolleys
Consigne mural pour caddies

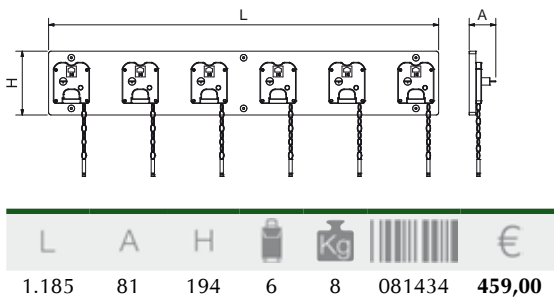

Taquilla - Consigna

Left-shopping - Lockers
Casiers - Consigne

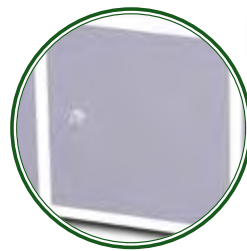
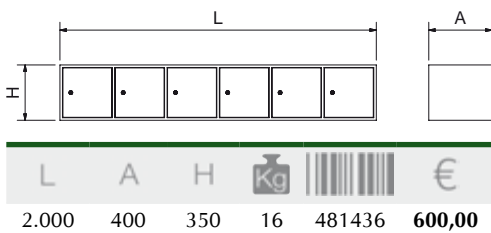

Repuestos y complementos

Spare part and complements
Rechange et compléments



Cerradura
Lock
Serrure

Gr Barcode €

41 481404 5,00



Cerradura maestra
Master lock
Serrure master

481405 8,00



Llave maestra para cerraduras
Master key for locks
Clé passe-partout pour serrures

10 481402 3,00



Cerradura de retorno de monedas
Coin operated lock
Serrure à monnaies

790 → 481410 45,00
← 481412









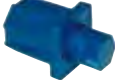

Montaje de la cerradura de retorno de monedas (no incluye cerradura)
Assembly coin operated lock (lock not included in this price)
Montage serrure à monnaies (serrure n'inclus pas dans ce prix)

081452 30,00

Repuestos y complementos

Spare part and complements

Rechange et compléments

		Gr	Barcode	€
	Pomo articulado Articulated handle Poignée articulée	80	481406	5,50
	Candado para pomo articulado Padlock for articulated handle Cadenas poignée articulée	105	481408	22,00
	Juego de herrajes para puertas (para 2 puertas) Sliding doors fixtures set (valid for two doors) Set de ferrures pour portes coulissantes (valide pour deux portes)	85	073850	63,00
	Taco regulable Adjustable blocks Taquets réglables	45	409851	1,34
	Taco regulable altura especial Special height adjustable blocks Taquets réglables hayteur spéciale	115	409848	2,75
	Tirador para puerta abatible Handle for hinged door Poignet pour porte battante	80	474050	6,00
	Cierre de clip de bolas Roller bracket closing Fermeture à rouleau	40	474052	4,50
	Llavero numerado Numbered key chain Porte-clés numérotés	30	481438	1,50
	Placa numerada Numbered plate Plaque numérotée	20	481439	1,20
	Cerradura con cadena para consigna de carros Locker with chain for left-shopping trolleys Serrure avec chaîne pour consigné pour caddies	850	481430	63,00
	Cerradura electrónica para taquilla Electronic lock for lockers Serrure électronique pour la porte vestiaire	584	→ 481418 ← 481419	77,00
	Montaje cerradura electrónica en puerta de taquilla (no incluye cerradura) Installation of electronic lock for lockers (lock not included) Montage serrure électronique sur porte de vestiaire (la serrure n'est pas incluse)		081454	30,00

