

Tavoli refrigerati

gastronomia GN1/1 - ventilati e linea snack

IT Gruppo incorporato estraibile per facile manutenzione - andamento circolare dell'aria fredda in modo da non toccare direttamente il prodotto - controllo temperatura elettronico con termostato digitale - resistenza elettrica intorno alla cornice porta per eliminazione della condensa - sbrinamento automatico con resistenza elettrica e controllo automatico della temperatura di sbrinamento - evaporazione automatica dell'acqua di condensa - evaporatore trattato anticorrosione. Porta con molla di ritorno - guarnizione porta estraibile senza utensili - fondo con angoli arrotondati - facile intercambiabilità porte con cassettiere da due e tre cassetti - cassettiere facilmente estraibili con guide telescopiche in acciaio inox. Piedini in acciaio Inox regolabili in altezza - possibilità di appoggio al muro.









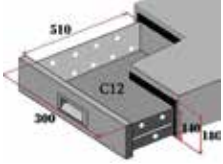
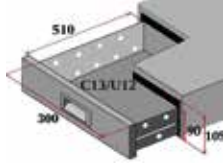











EN Built-in extractable unit for easy maintenance - circular cold air flow to avoid direct impact on the product - electronic temperature control with digital thermostat - electrical heating element around the door frame to prevent condensation - automatic defrosting with electrical heating element and automatic defrosting temperature control - automatic evaporation of condensate water - anti-corrosion treated evaporator. Door with self-closing spring - tool-free extractable door gasket - bottom with rounded corners - easy substitution of doors with two or three drawer units - easily extractable drawer units with stainless steel telescopic slides. Height-adjustable feet in stainless steel - can be placed against the wall.





















FR Unité extractible intégrée pour un entretien facile - flux d'air froid circulaire pour ne pas toucher directement le produit - régulation électronique de la température avec thermostat digital - résistance électrique autour du cadre de la porte pour éliminer la condensation - dégivrage automatique avec résistance électrique et régulation automatique de la température de dégivrage - évaporation automatique de l'eau de condensation - évaporateur traité anti-corrosion. Porte avec ressort auto-fermant - joint de porte extractible sans outils - fond avec coins arrondis - remplacement aisé des portes par éléments de deux ou trois tiroirs - blocs-tiroirs amovibles avec glissières télescopiques en acier inox. Pieds en acier inox réglables en hauteur - peut être placé contre le mur.

ES Unidad extraíble incorporada para un fácil mantenimiento - circuito de aire frío circular para evitar el impacto directo sobre el producto - control de temperatura electrónico con termostato digital - elemento de calefacción eléctrico alrededor del marco de la puerta para evitar la condensación - descongelación automática con elemento de calefacción eléctrico y control automático de la temperatura de descongelación - evaporación automática del agua condensada - evaporador con tratamiento anticorrosivo. Puerta con muelle de cierre automático - junta de la puerta extraíble sin herramientas - fondo con esquinas redondeadas - fácil sustitución de puertas por unidades de dos o tres cajones - cajones fáciles de extraer con correderas telescópicas de acero inoxidable. Patas de altura regulable en acero inoxidable - pueden colocarse contra la pared

Optional

CG11-FC	GRP11-FC	C12-FC mod. TN	C13-FC mod. TN	CGG mod. SNACK	GRPG mod. SNACK 33x43 cm
Coppia guide per griglia Pair of slides for grid Paire de glissières pour grille Par de guías para rejilla	Griglia plastificata Plastic coated grid Grille plastifiée Rejilla plastificada	Set. 2 cassetti / drawers Set. 2 tiroirs / cajones 	Set. 3 cassetti / drawers Set. 3 tiroirs / cajones 	Coppia guide per griglia Pair of slides for grid Paire de glissières pour grille Par de guías para rejilla	Griglia plastificata Plastic coated grid Grille plastifiée Rejilla plastificada

	G-SNACK3100TN-FC	G-SNACK3200TN-FC
	-2°C / +8°C	-2°C / +8°C
	1795 x 600 x 850(h) mm	1795 x 600 x 950(h) mm
	1335 x 430 x 560(h) mm	1335 x 430 x 560(h) mm
	239 L	239 L
	+35°C / 50%HR	+35°C / 50%HR
	ventilata / ventilated	ventilata / ventilated
DEFROST	elettrico / electric	elettrico / electric
GAS	R600a	R600a
	automatica / automatic	automatica / automatic
	elettronico / electronic	elettronico / electronic
	60 mm	60 mm
	275 W	275 W
	230V / 50Hz	230V / 50Hz
MATERIAL	acciaio Inox / stainless steel	acciaio Inox / stainless steel
	no	no
	no	no
STANDARD	3 griglie / grids 33x43 cm 3 coppie di guide / pairs of slides	3 griglie / grids 33x43 cm 3 coppie di guide / pairs of slides
ENERGY CLASS		
		
	103 Kg	103 Kg
	127 Kg	127 Kg
	1825 x 630 x 880(h) mm	1825 x 630 x 980(h) mm

	G-SNACK4100TN-FC	G-SNACK4200TN-FC
	-2°C / +8°C	-2°C / +8°C
	2230 x 600 x 850(h) mm	2230 x 600 x 950(h) mm
	1772 x 530 x 560(h) mm	1772 x 530 x 560(h) mm
	342 L	342 L
	+35°C / 50%HR	+35°C / 50%HR
	ventilata / ventilated	ventilata / ventilated
DEFROST	elettrico / electric	elettrico / electric
GAS	R600a	R600a
	automatica / automatic	automatica / automatic
	elettronico / electronic	elettronico / electronic
	60 mm	60 mm
	398 W	398 W
	230V / 50Hz	230V / 50Hz
MATERIAL	acciaio Inox / stainless steel	acciaio Inox / stainless steel
	no	no
	no	no
STANDARD	4 griglie / grids 33x43 cm 4 coppie di guide / pairs of slides	4 griglie / grids 33x43 cm 4 coppie di guide / pairs of slides
ENERGY CLASS		
		
	194 Kg	194 Kg
	225 Kg	225 Kg
	2260 x 630 x 880(h) mm	2260 x 630 x 980(h) mm