

Tavoli refrigerati

gastronomia GN1/1 - ventilati e linea snack

IT Gruppo incorporato estraibile per facile manutenzione - andamento circolare dell'aria fredda in modo da non toccare direttamente il prodotto - controllo temperatura elettronico con termostato digitale - resistenza elettrica intorno alla cornice porta per eliminazione della condensa - sbrinamento automatico con resistenza elettrica e controllo automatico della temperatura di sbrinamento - evaporazione automatica dell'acqua di condensa - evaporatore trattato anticorrosione. Porta con molla di ritorno - guarnizione porta estraibile senza utensili - fondo con angoli arrotondati - facile intercambiabilità porte con cassettiere da due e tre cassetti - cassettiere facilmente estraibili con guide telescopiche in acciaio inox. Piedini in acciaio Inox regolabili in altezza - possibilità di appoggio al muro.

EN Built-in extractable unit for easy maintenance - circular cold air flow to avoid direct impact on the product - electronic temperature control with digital thermostat - electrical heating element around the door frame to prevent condensation - automatic defrosting with electrical heating element and automatic defrosting temperature control - automatic evaporation of condensate water - anti-corrosion treated evaporator. Door with self-closing spring - tool-free extractable door gasket - bottom with rounded corners - easy substitution of doors with two or three drawer units - easily extractable drawer units with stainless steel telescopic slides. Height-adjustable feet in stainless steel - can be placed against the wall.

FR Unité extractible intégrée pour un entretien facile - flux d'air froid circulaire pour ne pas toucher directement le produit - régulation électronique de la température avec thermostat digital - résistance électrique autour du cadre de la porte pour éliminer la condensation - dégivrage automatique avec résistance électrique et régulation automatique de la température de dégivrage - évaporation automatique de l'eau de condensation - évaporateur traité anti-corrosion. Porte avec ressort auto-fermant - joint de porte extractible sans outils - fond avec coins arrondis - remplacement aisé des portes par éléments de deux ou trois tiroirs - blocs-tiroirs amovibles avec glissières télescopiques en acier inox. Pieds en acier inox réglables en hauteur - peut être placé contre le mur.

ES Unidad extraíble incorporada para un fácil mantenimiento - circuito de aire frío circular para evitar el impacto directo sobre el producto - control de temperatura electrónico con termostato digital - elemento de calefacción eléctrico alrededor del marco de la puerta para evitar la condensación - descongelación automática con elemento de calefacción eléctrico y control automático de la temperatura de descongelación - evaporación automática del agua condensada - evaporador con tratamiento anticorrosivo. Puerta con muelle de cierre automático - junta de la puerta extraíble sin herramientas - fondo con esquinas redondeadas - fácil sustitución de puertas por unidades de dos o tres cajones - cajones fáciles de extraer con correderas telescópicas de acero inoxidable. Patas de altura regulable en acero inoxidable - pueden colocarse contra la pared

Optional

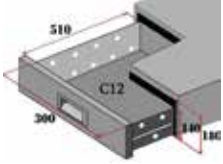
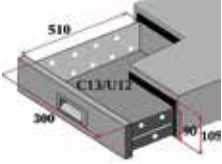
| CG11-FC | GRP11-FC | C12-FC mod. TN | C13-FC mod. TN | CGG mod. SNACK | GRPG mod. SNACK 33x43 cm |
|---|--|--|--|---|--|
| Coppia guide per griglia Pair of slides for grid Paire de glissières pour grille Par de guías para rejilla | Griglia plastificata Plastic coated grid Grille plastifiée Rejilla plastificada | Set. 2 cassetti / drawers Set. 2 tiroirs / cajones  | Set. 3 cassetti / drawers Set. 3 tiroirs / cajones  | Coppia guide per griglia Pair of slides for grid Paire de glissières pour grille Par de guías para rejilla | Griglia plastificata Plastic coated grid Grille plastifiée Rejilla plastificada |

G-GN2100TN-FC / G-GN2100BT-FC























G-GN3100TN-FC / G-GN3100BT-FC























G-GN4100TN-FC / G-GN4100BT-FC



| | G-GN2100TN-FC | G-GN2100BT-FC |
|--------------|--|--|
| | | |
| | -2°C / +8°C | -18°C / -22°C |
| | 1360 x 700 x 850(h) mm | 1360 x 700 x 850(h) mm |
| | 900 x 530 x 560(h) mm | 900 x 530 x 560(h) mm |
| | 282 L | 282 L |
| | +35°C / 50%HR | +35°C / 50%HR |
| | ventilata / ventilated | ventilata / ventilated |
| DEFROST | elettrico / electric | elettrico / electric |
| GAS | R600a | R290 |
| | automatica / automatic | automatica / automatic |
| | elettronico / electronic | elettronico / electronic |
| CONTROL | 60 mm | 60 mm |
| | 275 W | 675 W |
| | 230V / 50Hz | 230V / 50Hz |
| MATERIAL | acciaio Inox / stainless steel | acciaio Inox / stainless steel |
| | no | no |
| | no | no |
| STANDARD | 2 griglie / grids GN1/1 2 coppie di guide / pairs of slides | 2 griglie / grids GN1/1 2 coppie di guide / pairs of slides |
| ENERGY CLASS | | |
| | | |
| | 92 Kg | 94 Kg |
| | 106 Kg | 109 Kg |
| | 1390 X 730 x 880(h) mm | 1390 x 730 x 880(h) mm |

|  | G-GN3100TN-FC | G-GN3100BT-FC |
|---|---|---|
|  | -2°C / +8°C | -18°C / -22°C |
|  | 1795 x 700 x 850(h) mm | 1795 x 700 x 850(h) mm |
|  | 1335 x 530 x 560(h) mm | 1335 x 530 x 560(h) mm |
|  | 417 L | 417 L |
|  | +35°C / 50%HR | +35°C / 50%HR |
|  | ventilata / ventilated | ventilata / ventilated |
| DEFROST | elettrico / electric | elettrico / electric |
| GAS | R600a | R290 |
|  | automatica / automatic | automatica / automatic |
|  | elettronico / electronic | elettronico / electronic |
|  | 60 mm | 60 mm |
|  | 275 W | 675 W |
|  | 230V / 50Hz | 230V / 50Hz |
| MATERIAL | acciaio Inox / stainless steel | acciaio Inox / stainless steel |
|  | no | no |
|  | no | no |
| STANDARD | 3 griglie / grids GN1/1 3 coppie di guide / pairs of slides | 3 griglie / grids GN1/1 3 coppie di guide / pairs of slides |
| ENERGY CLASS |  |  |
|  | | |
|  | 114 Kg | 124 Kg |
|  | 126 Kg | 139 Kg |
|  | 1825 x 730 x 880(h) mm | 1825 x 730 x 880(h) mm |

|  | G-GN4100TN-FC | G-GN4100BT-FC |
|---|---|---|
|  | -2°C / +8°C | -18°C / -22°C |
|  | 2230 x 700 x 850(h) mm | 2230 x 700 x 850(h) mm |
|  | 1772 x 630 x 560(h) mm | 1772 x 630 x 560(h) mm |
|  | 553 L | 553 L |
|  | +35°C / 50%HR | +35°C / 50%HR |
|  | ventilata / ventilated | ventilata / ventilated |
| DEFROST | elettrico / electric | elettrico / electric |
| GAS | R290 | R290 |
|  | automatica / automatic | automatica / automatic |
|  | elettronico / electronic | elettronico / electronic |
|  | 60 mm | 60 mm |
|  | 398 W | 675 W |
|  | 230V / 50Hz | 230V / 50Hz |
| MATERIAL | acciaio Inox / stainless steel | acciaio Inox / stainless steel |
|  | no | no |
|  | no | no |
| STANDARD | 4 griglie / grids GN1/1 4 coppie di guide / pairs of slides | 4 griglie / grids GN1/1 4 coppie di guide / pairs of slides |
| ENERGY CLASS |  |  |
|  | | |
|  | 132 Kg | 147 Kg |
|  | 153 Kg | 168 Kg |
|  | 2260 x 760 x 880(h) mm | 2260 x 760 x 880(h) mm |