

BC5NV BC8NV













BC5NV



Cutter

- IT** Carcassa in alluminio anodizzato - vasca e lame estraibili in acciaio inox - coperchio superiore in policarbonato alimentare trasparente - microinterruttori di sicurezza su coperchio e vasca - capacità vasca 5-8 litri - dotato di coltello a 2 lame taglienti - variatore di velocità.
- EN** Anodized aluminium casing - removable stainless steel bowl and blades - upper lid in clear alimentary polycarbonate - safety microswitches on lid and bowl - bowl capacity 5-8 litres - equipped with a knife with 2 sharp blades - double speed.
- FR** Corps en aluminium anodisé - cuve et lames amovibles en acier Inox - couvercle supérieur en polycarbonate alimentaire transparent - microinterrupteur de sécurité sur le couvercle et la cuve - capacité cuve 5-8 litres - équipé d'un couteau avec 2 lames pointues - double vitesse.
- DE** Eloxiertes Aluminiumgehäuse - abnehmbare Edelstahlschüssel und -klingen - oberer Deckel aus durchsichtigem lebensmitteltauglichem Polykarbonat - Druckknopf - Sicherheitsmikroschalter am Deckel und Schüsselträgerfuß - Motorbremse - Schüsselinhalt 5-8 Liter - ausgestattet mit einem Messer mit 2 scharfen Klingen - doppelte Geschwindigkeit.
- ES** Carcasa de aluminio anodizado - bol y cuchillas extraíbles de acero inoxidable AISI 304 - tapa superior de policarbonato transparente para alimentos - microinterruptores de seguridad en la tapa y el bol - capacidad del bol 5-8 litros - dotado de cuchillo con 2 hojas cortantes. - variador de velocidad.
- RU** Корпус из анодированного алюминия - Съемная чаша и лезвия из нержавеющей стали - прозрачная верхняя крышка из поликарбоната - кнопка - предохранительный микровыключатель на крышке и опорной лапке - моторный тормоз - объем барабана 5-8 литров - оснащен ножом с 2 острыми лезвиями - двойная скорость.

	BC5NV	BC8NV
	0,75 kW (1 HP)	
	230V/1N/50Hz	
	260±2120 rpm	
	5 L ø 210 x 160(h) mm max. 2,8 L	8 L ø 210 x 210(h) mm max. 4 L
	710 x 320 x 850(h) mm	710 x 320 x 900(h) mm
		
	24 Kg	25 Kg
	26 Kg	27 Kg
	485 x 630 x 530(h) mm	485 x 630 x 550(h) mm
	0,160 m³	0,170 m³

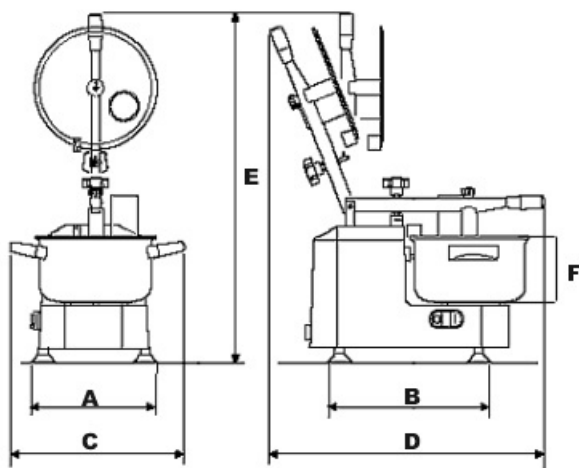

	BC5NV	BC8NV
A	260 mm	
B	360 mm	
C	320 mm	
D	710 mm	
E	850 mm	900 mm
F	160 mm	210 mm