

11

REPUESTOS Y ACCESORIOS PART AND SPARES PART ET ACCESSOIRES

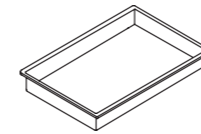

CUBETAS Página 484
Cubetas gastronorm de acero inoxidable
Stainless steel gastronorm containers
Bacs gastro

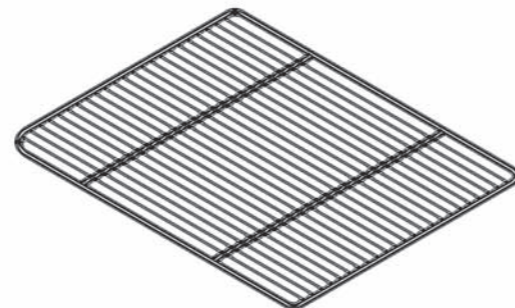
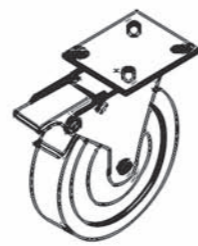
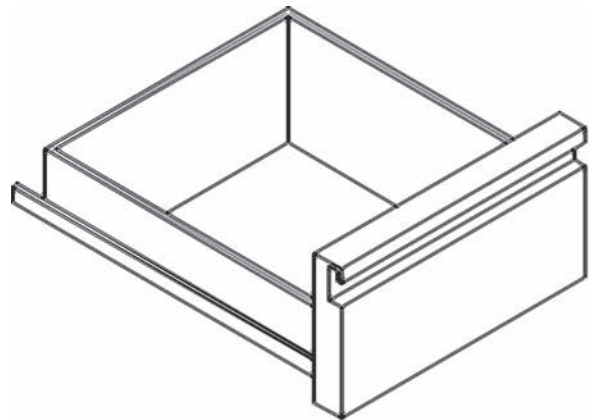
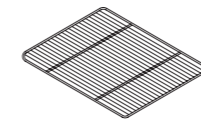

PARRILLAS Página 485
Parrillas
Shelf
Clayettes

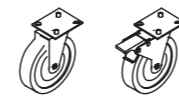

RUEDAS Página 487
Ruedas
Castors
Roulettes

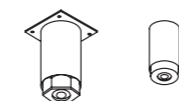

PATAS Página 487
Patas
Feets
Pieds



CERRADURAS Página 487
Cerraduras
Lock
Fermeture

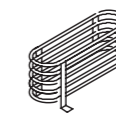

CONDENSACIÓN Página 488
Condensación mixta aire - agua
Mixed condensation air - water
Condensation mixte air-eau

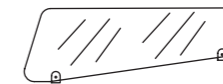

SEPARADORES Página 488
Separadores
Separators
Séparateur

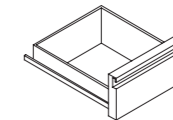

CAJONES Página 488
Cajones
Drawers
Tiroir

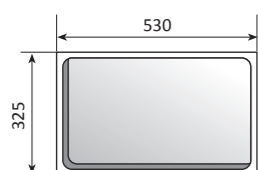
CUBETAS GASTRONORMA DE ACERO INOXIDABLE · STAINLESS STEEL GASTRONORM CONTAINERS · BACS GASTRO
GN 1/1 325 X 530

REF.	DESCRIPCIÓN DESCRIPTION/DESCRIPTION	FONDO DEPTH / PROFONDEUR	PRECIOS PRICE / PRIX (€)
6041090031	GN 1/1-20	20 mm	
6041090032	GN 1/1-40	40 mm	
6041090024	GN 1/1-65	65 mm	
6041090014	GN 1/1-100	100 mm	
6041090013	GN 1/1-150	150 mm	
6041090033	GN 1/1-200	200 mm	

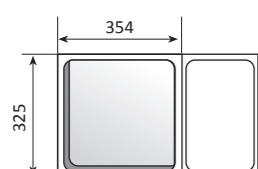
GN 2/3 325 X 354

6041090034	GN 2/3-20	20 mm	
6041090035	GN 2/3-40	40 mm	
6041090036	GN 2/3-65	65 mm	
6041090037	GN 2/3-100	100 mm	
6041090038	GN 2/3-150	150 mm	
6041090039	GN 2/3-200	200 mm	

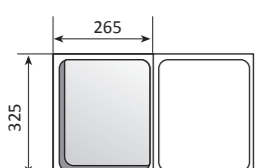
GN 1/2 325 X 265

6041090040	GN 1/2-20	20 mm	
6041090041	GN 1/2-40	40 mm	
6041090006	GN 1/2-65	65 mm	
6041090022	GN 1/2-100	100 mm	
6041090017	GN 1/2-150	150 mm	
6041090042	GN 1/2-200	200 mm	

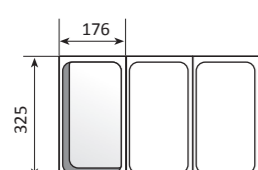
GN 1/3 325 X 176

6041090043	GN 1/3-20	20 mm	
6041090003	GN 1/3-40	40 mm	
6041090044	GN 1/3-65	65 mm	
6041090007	GN 1/3-100	100 mm	
6041090009	GN 1/3-150	150 mm	
6041090008	GN 1/3-200	200 mm	

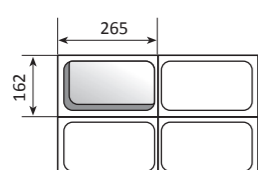
GN 1/4 162 X 265

6041090045	GN 1/4-20	20 mm	
6041090010	GN 1/4-40	40 mm	
6041090046	GN 1/4-65	65 mm	
6041090018	GN 1/4-100	100 mm	
6041090021	GN 1/4-150	150 mm	
6041090047	GN 1/4-200	200 mm	

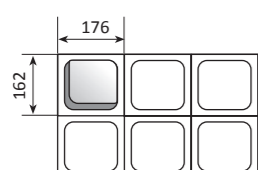
GN 1/6 176 X 162

6041090023	GN 1/6-65	65 mm	
6041090011	GN 1/6-100	100 mm	
6041090012	GN 1/6-150	150 mm	
6041090048	GN 1/6-200	200 mm	

MESAS SERIE SNACK SNACK COUNTERS RANGE MEUBLES SNACK ET FMR	DESCRIPCIÓN DESCRIPTION DESCRIPTION	PARA MODELO SUITABLE FOR MODEL POUR MODÈLE	PRECIOS (€) PRICE PRIX
	D2001R002	Parrilla acero plastificado centro 405x525 405X525 central laminated shelf Clayettes inox plastifié centre 405x525	BMR - CMR
	6027050012	Parrilla acero inoxidable centro 405x525 405X525 central staint steel shelf Clayettes inox plastifié centre 405x525	BMR - CMR
	D2001R001	Parrilla acero plastificado lateral 405x460 405X460 lateral laminated shelf Clayettes inox plastifié côté 405x460	BMR - CMR
	6027050018	Parrilla acero inoxidable lateral 405x460 405X460 lateral staint steel shelf Clayettes inox plastifié côté 405x460	BMR - CMR

GN Y 600X400	DESCRIPCIÓN DESCRIPTION DESCRIPTION	PARA MODELO SUITABLE FOR MODEL POUR MODÈLE	PRECIOS (€) PRICE PRIX
	270100001	Parrilla acero plastificado GN 1/1 GN 1/1 laminated shelf Clayettes inox plastifié GN 1/1	BRG
	270500001	Parrilla acero inoxidable GN 1/1 GN 1/1 staint steel shelf Clayettes inox GN 1/1	BRG
	270100002	Parrilla acero plastificado GN 2/1 GN 1/1 laminated shelf Clayettes inox plastifié GN 1/1	ARG
	270500002	Parrilla acero inoxidable GN 2/1 GN 1/1 staint steel shelf Clayettes inox GN 1/1	ARG
	270100004	Parrilla acero plastificado 600X400 600X400 laminated shelf Clayettes inox plastifié 600X400	AEP
	270500003	Parrilla acero inoxidable 600X400 600X400 staint steel shelf Clayettes inox 600X400	AEP

ARMARIOS SERIE SNACK SNACK CABINETS RANG ARMOIRES RÉFRIGÉRÉES SNACK ET EUROSNAK	DESCRIPCIÓN DESCRIPTION DESCRIPTION	PARA MODELO SUITABLE FOR MODEL POUR MODÈLE	PRECIOS (€) PRICE PRIX
	D0101R002	Parrilla acero plastificado 560x542 560X542 laminated shelf Clayettes inox plastifié 560x542	AR
	D0101R003	Parrilla acero inoxidable 560x542 560X542 staint steel shelf Clayettes inox 560x542	AR
	6027010086	Parrilla intermedia acero plastificado 160x500 160X500 intermediate laminated shelf Clayettes inox plastifié 160x500	AR
	6027050014	Parrilla intermedia acero inoxidable 160x500 160X500 intermediate staint steel shelf Clayettes inox 160x500	AR
	270100003	Parrilla acero plastificado 485X530 485X530 laminated shelf Clayettes inox plastifié 485X530	AR/ACR/ACE-125

ARMARIOS EUROSNAK EUROSNAK CABINETS EUROSNAK CABINETS	DESCRIPCIÓN DESCRIPTION DESCRIPTION	PARA MODELO SUITABLE FOR MODEL POUR MODÈLE	PRECIOS (€) PRICE PRIX
6027010097	Parrilla acero plastificado 480x450 480X450 laminated shelf Clayettes inox plastifié 480x450	AER, AERE, AEC	
270100003	Parrilla acero plastificado 485X530 485X530 laminated shelf Clayettes inox plastifié 485X530	AR/ACR/ACE-125	

FLUORESCENTES PARA CARNE FLUORESCENT MEAT VIANDE FLUORESCENT	DESCRIPCIÓN DESCRIPTION DESCRIPTION	PARA MODELO SUITABLE FOR MODEL POUR MODÈLE	PRECIOS (€) PRICE PRIX
	Fluorescentes para carne 30 W Fluorescent meat Viande fluorescent		
	Fluorescentes para carne 36 W Fluorescent meat Viande fluorescent		

MESAS SERIE SNACK SNACK COUNTERS RANGE MEUBLES SNACK	DESCRIPCIÓN DESCRIPTION DESCRIPTION	PARA MODELO SUITABLE FOR MODEL POUR MODÈLE	PRECIOS (€) PRICE PRIX
	6027010055 Parrilla acero plastificado Laminated steel shelf Clayettes inox plastifié	EHB-150	
	6027010052 Parrilla acero plastificado Laminated steel shelf Clayettes inox plastifié	EHB-250 EHB-250	
	6027010068 Parrilla acero plastificado Laminated steel shelf Clayettes inox plastifié	EHB-350	
	6027010042 Parrilla acero plastificado Laminated steel shelf Clayettes inox plastifié	DRVCS-1000	

BOTELLEROS Y ESCARCHACOPAS BOTTLE COOLERS AND GLASS FROSTER REFROIDISSEUR A VERRES	DESCRIPCIÓN DESCRIPTION DESCRIPTION	PARA MODELO SUITABLE FOR MODEL POUR MODÈLE	PRECIOS (€) PRICE PRIX
	6027010067 Parrilla acero plastificado 528x440 528x440 laminated shelf Clayettes inox plastifié 528x440	DEC-140	
	6027010025 Parrilla acero plastificado 385x395 385x395 laminated shelf Clayettes inox plastifié 385x395	DEC-85 - DEE-85	
	6027130008 Parrilla acero plastificado 440x276 440x276 laminated shelf Clayettes inox plastifié 440x276	EBEG	
	6027130003 Separador interior acero plastificado 500x435 500x435 laminated shelf interior separator Separateur interieur en acier plastifié 500x435	EB	

BANDEJAS DE PLÁSTICO CONTAINERS CONTENEURS EN PLASTIQUE	DESCRIPCIÓN DESCRIPTION DESCRIPTION	PARA MODELO SUITABLE FOR MODEL POUR MODÈLE	PRECIOS (€) PRICE PRIX
	6003050007 Cajón 530x460x100 530x460x100 container Conteneur 530x460x100	ADP-DDP-140	
	6003050006 Cajón 530x540x100 530x540x100 container Conteneur 530x540x100	ARM-ARGP-ARGM	
	6003010077 Cajón 600x400x120 600x400x120 container Conteneur 600x400x120	AEP	
	6003010430 Cajón 410x458x143 410x458x143 container Conteneur 410x458x143	AEP-400	
	6003010079 Cajón 600x400x70 600x400x70 container Conteneur 600x400x70	MP-MR	

BARRAS CARNICERAS MEAT BARS BARRES BOUCHERS	DESCRIPCIÓN DESCRIPTION DESCRIPTION	PARA MODELO SUITABLE FOR MODEL POUR MODÈLE	PRECIOS (€) PRICE PRIX
	A165090005 Juego barras carniceras armarios snack Snack cabinets meat bars Kit barres bouchers armoire snack	Todos excepto gama 55 y 125 All except 55 and 125 range Tous les modèles sauf series 55 et 125	
	A165090003 Juego barras carniceras armarios GN 2/1 GN 2/1 cabinets meat bars Kit barres bouchers armoire snack GN 2/1		
	A165090006 Juego barras carniceras armarios Eurosnack Eurosnack cabinets meat bars Kit barres bouchers armoire snack Eurosnack	Todos excepto gama 55 y 125 All except 55 and 125 range Tous les modèles sauf series 55 et 125	
	621800006 Juego barras carniceras armarios snack 125 Snack 125 cabinets meat bars	ACR/ACC/ACRV-125	
	A165090008 Juego barras carniceras armarios snack Snack cabinets meat bars Kit barres bouchers armoire snack	ACR/ACC/ACRV-55	
	A165090009 Juego barras carniceras armarios GN 1/1 GN 1/1 cabinets meat bars Kit barres bouchers armoire snack GN 1/1		

GUÍAS PARA PARRILLAS Y BANDEJAS SLIDES FOR SHELF AND TRAYS GUIDES POUR CLAYETTES ET CONTENEURS	DESCRIPCIÓN DESCRIPTION DESCRIPTION	PARA MODELO SUITABLE FOR MODEL POUR MODÈLE	PRECIOS (€) PRICE PRIX
	340500007 Par de guías en "U", longitud 519 mm. 519 mm. length slides set, "U" design Paire de guides en "U", largeur 519 mm.	ARSP	
	340500001 Par de guías en "U", longitud 549 mm. 549 mm. length slides set, "U" design Paire de guides en "U", largeur 549 mm.	Armarios gama 125 y 50	
	340500006 Par de guías en "U", longitud 562 mm. 562 mm. length slides set, "U" design Paire de guides en "U", largeur 562 mm.	Mesas GN 1/1 - ACM	
	340500002 Par de guías en "U", longitud 613 mm. 613 mm. length slides set, "U" design Paire de guides en "U", largeur 613 mm.	MFCG-ARGP-AR-55	
	340500008 Par de guías en "U", longitud 662 mm. 662 mm. length slides set, "U" design Paire de guides en "U", largeur 662 mm.	Armarios GN 2/1	
	6033050026 Par de guías en "L", longitud 485 mm. 485 mm. length slides set, "L" design Paire de guides en "L", largeur 485 mm.	ARP-750	
	340500003 Par de guías en "L", longitud 613 mm. 613 mm. length slides set, "L" design Paire de guides en "L", largeur 613 mm.	AR-55/AEP/ARP AEPE-55	
	340500004 Par de guías en "L", longitud 649 mm. 649 mm. length slides set, "L" design Paire de guides en "L", largeur 649 mm.	Mesas 600x400	
	340500009 Par de guías en "L", longitud 662 mm. 662 mm. length slides set, "L" design Paire de guides en "L", largeur 662 mm.	ARP/ACP-750 ARP/ACP-1002	

JUEGO DE RUEDAS CASTORS SETS ROULETTES	DESCRIPCIÓN DESCRIPTION DESCRIPTION	PARA MODELO SUITABLE FOR MODEL POUR MODÈLE	PRECIOS (€) PRICE PRIX
	611100001 Juego 4 ruedas (2 con freno + 2 sin freno) 4 castors set (2 with brakes + 2 without brakes) 4 Roulettes (2 avec freins+ 2 sans freins)		
	611100002 Juego 6 ruedas(3 con freno + 3 sin freno) 6 castors set (3 with brakes + 3 without brakes) 6 Roulettes (3 avec freins+ 3 sans freins)		

PATAS INOXIDABLES STAINLESS STEEL FEETS PIEDS INOX	DESCRIPCIÓN DESCRIPTION DESCRIPTION	PARA MODELO SUITABLE FOR MODEL POUR MODÈLE	PRECIOS (€) PRICE PRIX
	342500003 Patas inox 125 - 200 mm. 125 - 200 mm. stainless steel feet Pieds inox 125 - 200 mm		
	6007050079 Patas inox 95 - 125 mm. 95 - 125 mm. stainless steel feet Pieds inox 95 - 125 mm.	BCR	
	6007050031 Patas botellero Bottle cooler feet Pieds refroidisseur à bouteilles	EB	

CERRADURAS LOCKS FERMETURE PORTES	DESCRIPCIÓN DESCRIPTION DESCRIPTION	PARA MODELO SUITABLE FOR MODEL POUR MODÈLE	PRECIOS (€) PRICE PRIX
	A169220005 Conjunto cerradura puerta, apertura a izquierda Left hand opening lock set kit fermeture porte, gauche	Mesas frías Refrigerated counters Meuble réfrigéré	
	A169220006 Conjunto cerradura puerta, apertura a derecha Right hand opening lock set kit fermeture porte, droite	Mesas frías Refrigerated counters Meuble réfrigéré	
	A169220005 Conjunto cerradura puerta, apertura a izquierda Left hand opening lock set kit fermeture porte, gauche	Armarios, parte superior Cabinets, upper side Armoire haut	
	A169220006 Conjunto cerradura puerta, apertura a derecha Right hand opening lock set kit fermeture porte, droite	Armarios, parte superior Cabinets, upper side Armoire haut	
	A169220008 Conjunto cerradura puerta, apertura a izquierda Left hand opening lock set kit fermeture porte, gauche	Armarios, puerta inferior izq. Cabinets, small left door Armoire porte bas gauche	
	A169220007 Conjunto cerradura puerta, apertura a derecha Right hand opening lock set kit fermeture porte, droite	Armarios, puerta inferior der. Cabinets, small right door Armoire porte bas droite	

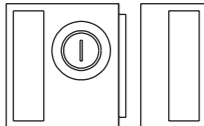
CERRADURAS LOCKS FERMETURE PORTES	DESCRIPCIÓN DESCRIPTION DESCRIPTION	PARA MODELO SUITABLE FOR MODEL POUR MODÈLE	PRECIOS (€) PRICE PRIX
	6033010075 Cerradura lateral Side lock Fermeture côté	DEC, DECC, DECCM, DEM, DECP	

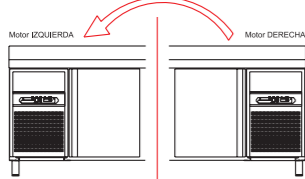
GRUPO LADO IZQUIERDO ENGINE IN LEFT SIDE GROUPE CÔTÉ DROITE	DESCRIPCIÓN DESCRIPTION DESCRIPTION	PARA MODELO SUITABLE FOR MODEL POUR MODÈLE	PRECIOS (€) PRICE PRIX
	Incremento motor lado izquierdo Engine in left side Augmentation prix moteur côté gauche	Mesas frías sin fregadero Snack counters without sink Meubles sans évier	55 €
	Incremento motor lado izquierdo Engine in left side Augmentation prix moteur côté gauche	Mesas frías con fregadero Snack counters with sink Meubles avec évier	190 €

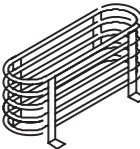
CONDENSACIÓN MIXTA AIRE - AGUA MIXED CONDENSATION AIR - WATER CONDENSATION MIXTE AIR-EAU	DESCRIPCIÓN DESCRIPTION DESCRIPTION	PARA MODELO SUITABLE FOR MODEL POUR MODÈLE	PRECIOS (€) PRICE PRIX
	Condensación mixta aire-agua Mixer condenser unit air-water Condensation mixte air-eau	Mesas y Armarios Refrigerados, Vitrina cerrada y mural Refrigerated counters and cabinets, closed and mural showcase Meubles et Armoires réfrigérés, Vitrine fermée et mureaux	

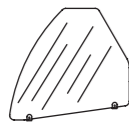
SEPARADOR AMBIENTE TEMPERATURE SEPARATOR SÉPARATEUR DE TEMPÉRATURE	DESCRIPCIÓN DESCRIPTION DESCRIPTION	PARA MODELO SUITABLE FOR MODEL POUR MODÈLE	PRECIOS (€) PRICE PRIX
	Separador ambiente para kit unión. Environment for binding separator kit L'environnement pour le kit séparateur contraignant.	índique modelo: VE-8 / VE-9 / VE-10 model indicate: VE-8 / VE-9 / VE-10 modèle indiquent: VE-8 / VE-9 / VE-10	

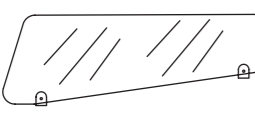
SEPARADOR GENERO PRODUCT SEPARATOR SÉPARATEUR PRODUIT	DESCRIPCIÓN DESCRIPTION DESCRIPTION	PARA MODELO SUITABLE FOR MODEL POUR MODÈLE	PRECIOS (€) PRICE PRIX
	Separador para genero. Product separator Séparateur produit.	índique modelo: VE-8 / VE-9 / VE-10 model indicate: VE-8 / VE-9 / VE-10 modèle indiquent: VE-8 / VE-9 / VE-10	

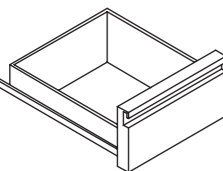
CAJONES AUXILIARES NEUTRAL DRAWERS TIROIRS AUXILIAIRES	DESCRIPCIÓN DESCRIPTION DESCRIPTION	PARA MODELO SUITABLE FOR MODEL POUR MODÈLE	PRECIOS (€) PRICE PRIX
	M269130007 Cajón neutro (repuesto) Neutral drawers (spare) Tiroir neutre (rechange)	CMC	
	M169130024 Cajón neutro CMR motor lado derecho (repuesto) FMR right hand engine drawer (spare) Tiroir neutre droite (rechange)	CMR - CMC	
	M169130025 Cajón neutro CMR motor lado izquierdo (repuesto) FMR left hand engine drawer (spare) Tiroir neutre gauche (rechange)	CMR - CMC	

TOLVA PARA CAFÉ CHUTE DRAWER FOR COFFEE WASTE TRÉMIE POUR CAFÉ	DESCRIPCIÓN DESCRIPTION DESCRIPTION	PARA MODELO SUITABLE FOR MODEL POUR MODÈLE	PRECIOS (€) PRICE PRIX
	M269170005 Cajón tolva especial posos café Drawer for coffee waste Spécial café trémie lie tiroir	CMC	
	M169170014 Cajón tolva especial posos café, CMR motor derecho. (repuesto) Drawer for coffee waste, right hand engine CMR (spare) Tiroir à marc de café spécial trémie, moteur droite CMR. (Remplacement)	CMR - CMC	
	M169170015 Cajón tolva especial posos café, CMR motor izquierdo. (repuesto) Drawer for coffee waste, left hand engine CMR (spare) Tiroir à marc de café spécial trémie, moteur gauche CMR. (Remplacement)	CMR - CMC	

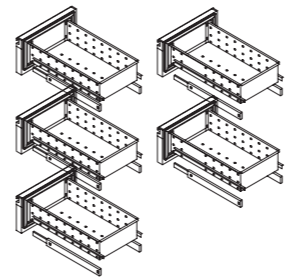
CAJONERAS REFRIGERADAS REFRIGERATED DRAWERS SET TIROIRS	DESCRIPCIÓN DESCRIPTION DESCRIPTION	PARA MODELO SUITABLE FOR MODEL POUR MODÈLE	PRECIOS (€) PRICE PRIX
	M169120152 Kit cajonera refrigerada 100+100 GN 1/1 GN 1/1 100+100 refrigerated drawers set Kit de tiroir réfrigéré 100+100 GN 1/1	BCR-DMF-MS-MP100/140	
	M169120153 Kit cajonera refrigerada 100+100+100 GN 1/1 GN 1/1 100+100+100 refrigerated drawers set Kit de tiroir réfrigéré 100+100+100 GN 1/1	Mesas GN 1/1 refrigeración Refrigerated GN 1/1 counters	
	M169120154 Kit cajonera refrigerada 100+300 GN 1/1 GN 1/1 100+300 refrigerated drawers set Kit de tiroir réfrigéré 100+300 GN 1/1	Mesas GN 1/1 refrigeración Refrigerated GN 1/1 counters	
	M169120155 Kit cajonera refrigerada 200+200 GN 1/1 (lado grupo) GN 1/1 200+200 refrigerated drawers set (engine side) Kit de tiroir réfrigéré 100+300 GN 1/1 (groupe lateral)	Mesas GN 1/1 refrigeración Refrigerated GN 1/1 counters	
	M169120156 Kit cajonera refrigerada 200+200 GN 1/1 GN 1/1 200+200 refrigerated drawers set Kit de tiroir réfrigéré 200+200 GN 1/1	Mesas GN 1/1 refrigeración Refrigerated GN 1/1 counters	
	M169120157 Kit cajonera refrigerada 100+100+100 snack Snack 100+100+100 refrigerated drawers set Kit de tiroir réfrigéré 100+100+100 snack	Mesas snack refrigeración Refrigerated snack counters	
	M169120158 Kit cajonera refrigerada 100+300 snack Snack 100+300 refrigerated drawers set Kit de tiroir réfrigéré 100+300 snack	Mesas snack refrigeración Refrigerated snack counters	
	M169120159 Kit cajonera refrigerada 200+200 snack (lado contra-grupo) Snack 200+200 refrigerated drawers set (opposite engine side) Kit de tiroir réfrigéré 200+200 snack (groupe oppose)	Mesas snack refrigeración Refrigerated snack counters	
	M169120160 Kit cajonera refrigerada 200+200 snack (lado grupo) Snack 200+200 refrigerated drawers set (engine side) Kit de tiroir réfrigéré 200+200 snack (groupe lateral)	Mesas snack refrigeración Refrigerated snack counters	
	M169120161 Kit cajonera refrigerada 200+200 snack Snack 200+200 refrigerated drawers set Kit de tiroir réfrigéré 200+200 snack	Mesas snack refrigeración Refrigerated snack counters	
	M169120162 Kit cajonera refrigerada 170+170+170 frente mostrador Back bar 170+170+170 refrigerated drawers set Kit de tiroir réfrigéré 170+170+170 CMR	Frente mostrador refrigerado Back-bar	
	M169120163 Kit cajonera refrigerada 170+450 frente mostrador Back bar 170+450 refrigerated drawers set Kit de tiroir réfrigéré 170+450 CMR	Frente mostrador refrigerado Back-bar	
	M169120164 Kit cajonera refrigerada 300+300 frente mostr (lado contra grupo) Back bar 300+300 refrigerated drawers set (opposite engine side) Kit de tiroir réfrigéré 170+450 CMR (groupe oppose)	Frente mostrador refrigerado Back-bar	
	M169120165 Kit cajonera refrigerada 300+300 frente mostrador (lado grupo) Back bar 300+300 refrigerated drawers set (engine side) Kit de tiroir réfrigéré 300+300 CMR (groupe lateral)	Frente mostrador refrigerado Back-bar	
	M169120166 Kit cajonera refrigerada 300+300 frente mostrador Back bar 300+300 refrigerated drawers set Kit de tiroir réfrigéré 300+300 CMR	Frente mostrador refrigerado Back-bar	

JUEGOS BISAGRAS HINGES SETS KIT CHARNIÈRES	DESCRIPCIÓN DESCRIPTION DESCRIPTION	PARA MODELO SUITABLE FOR MODEL POUR MODÈLE	PRECIOS (€) PRICE PRIX
	M169090003 Juego bisagras apertura izquierda mesas frías Hinge set left opening door refrigerated counter Jeu de charnières ouverture gauche meubles réfrigérés	Mesas frías Refrigerated counters Meubles réfrigérés	
	M169090004 Juego bisagras apertura derecha mesas frías Hinge set right opening door refrigerated counter Jeu de charnières ouverture droite meubles réfrigérés	Mesas frías Refrigerated counters Meubles réfrigérés	

JUEGOS BISAGRAS HINGES SETS KIT CHARNIÈRES	DESCRIPCIÓN DESCRIPTION DESCRIPTION	PARA MODELO SUITABLE FOR MODEL POUR MODÈLE	PRECIOS (€) PRICE PRIX
	A169090010 Juego bisagras apertura izquierda armarios Hinge set left opening door refrigerated cabinets Jeu de charnières ouverture gauche armoires	Armarios Cabinets Armoires	
	A169090011 Juego bisagras apertura derecha armarios Hinge set right opening door refrigerated cabinets Jeu de charnières ouverture droite armoires	Armarios Cabinets Armoires	

JUEGOS BISAGRAS HINGES SETS KIT CHARNIÈRES	DESCRIPCIÓN DESCRIPTION DESCRIPTION	PARA MODELO SUITABLE FOR MODEL POUR MODÈLE	PRECIOS (€) PRICE PRIX
	A169090012 Juego bisagra puerta intermedia lado derecho Right lide intermediate hinge set Jeu de charnières ouverture droite	Armarios Cabinets Armoires	
	A169090013 Juego bisagra puerta intermedia lado izquierdo Left lide intermediate hinge set Jeu de charnières ouverture gauche	Armarios Cabinets Armoires	

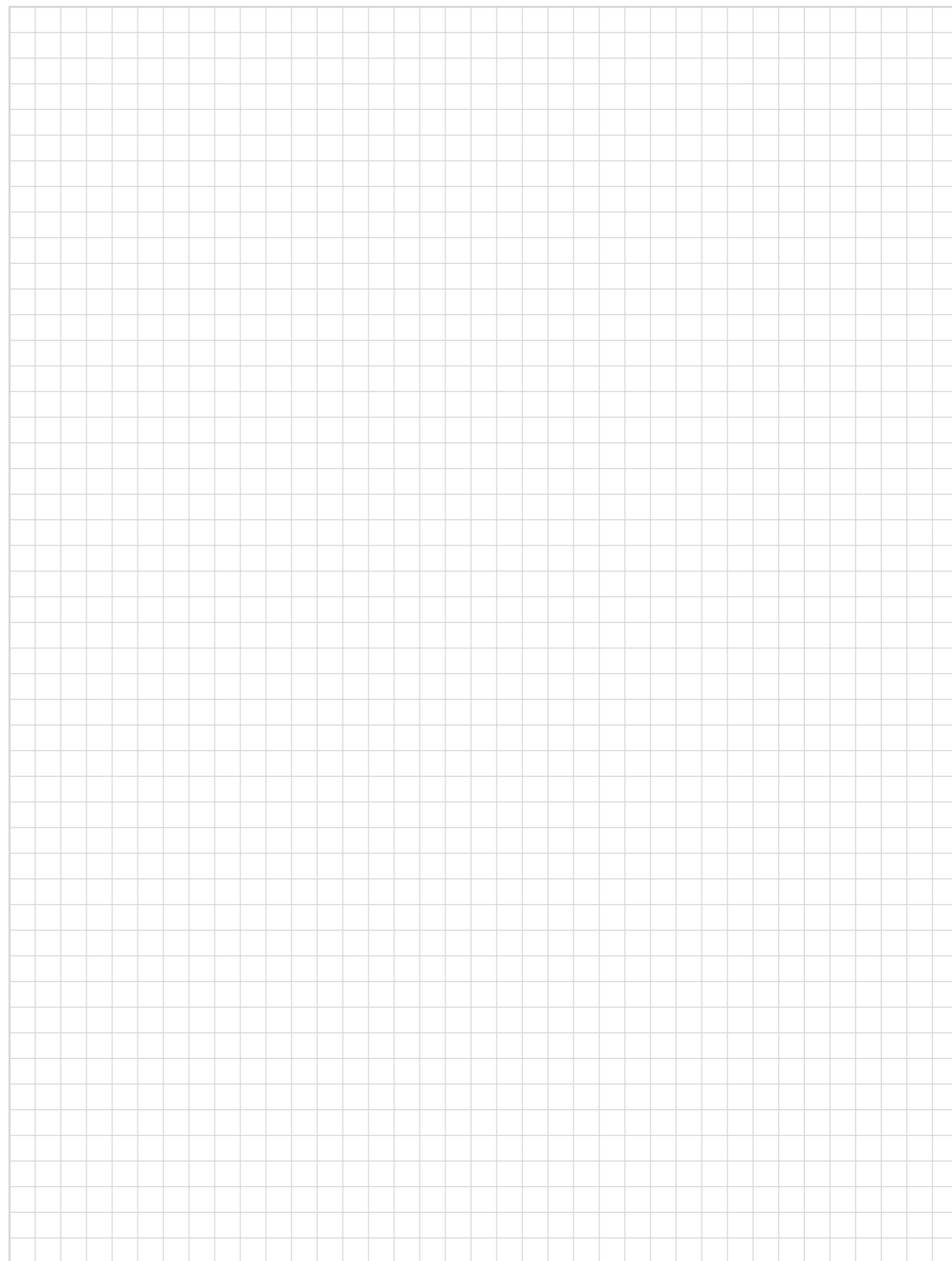
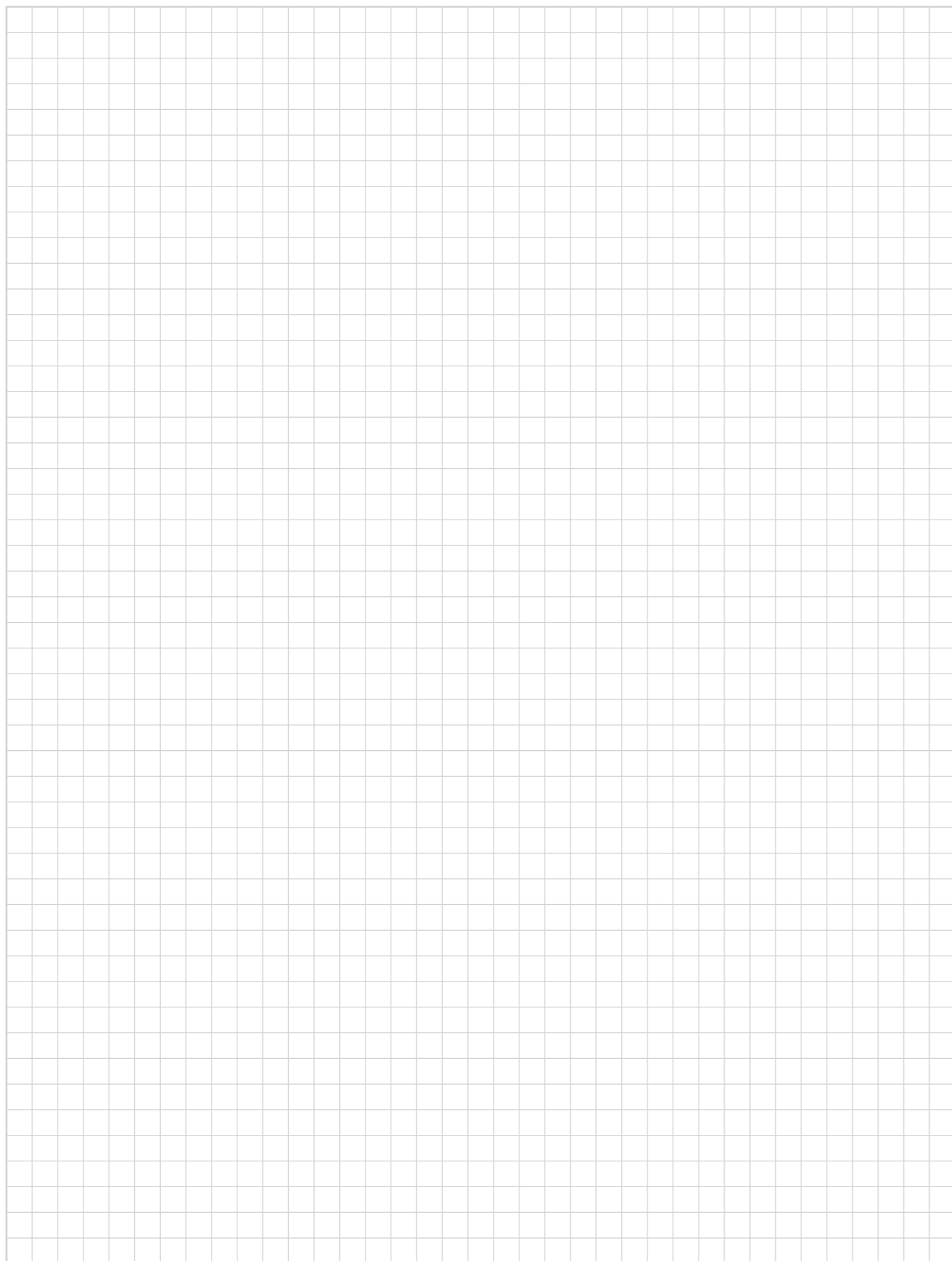



www.docriluc.com

