

11

REPUESTOS Y ACCESORIOS PART AND SPARES PART ET ACCESSOIRES

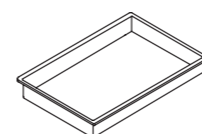

CUBETAS Página 484
Cubetas gastronorm de acero inoxidable
Stainless steel gastronorm containers
Bacs gastro

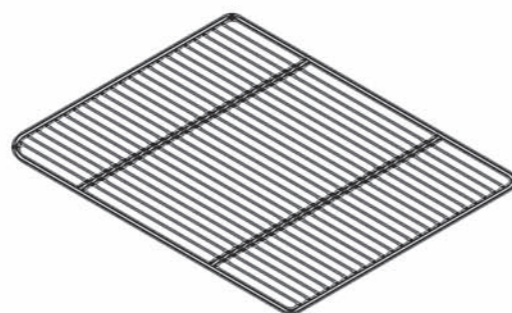
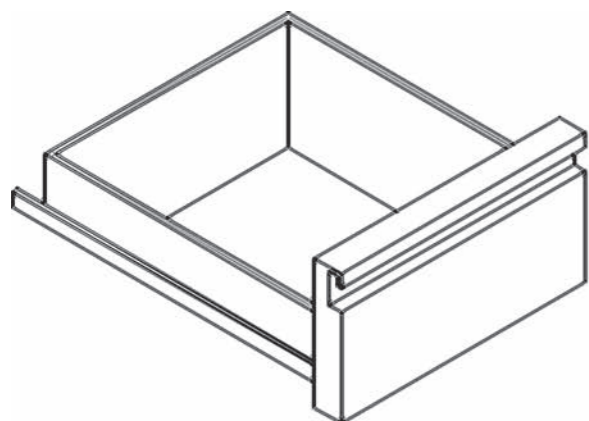
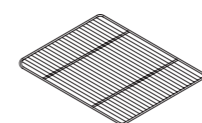

PARRILLAS Página 485
Parrillas
Shelf
Clayettes

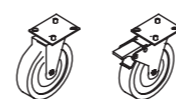

RUEDAS Página 487
Ruedas
Castors
Roulettes



PATAS Página 487
Patas
Feets
Pieds



CERRADURAS Página 487
Cerraduras
Lock
Fermeture

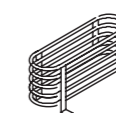

CONDENSACIÓN Página 488
Condensación mixta aire - agua
Mixed condensation air - water
Condensation mixte air-eau



SEPARADORES Página 488
Separadores
Separators
Séparateur

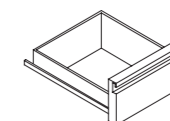

CAJONES Página 488
Cajones
Drawers
Tiroir

CUBETAS GASTRONORMA DE ACERO INOXIDABLE · STAINLESS STEEL GASTRONORM CONTAINERS · BACS GASTRO

GN 1/1 325 X 530

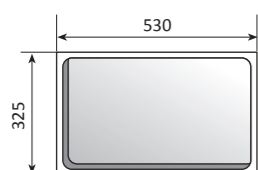

| REF. | DESCRIPCIÓN DESCRIPTION/DESCRIPTION | FONDO DEPTH / PROFONDEUR |
|------------|--|-----------------------------|
| 6041090031 | GN 1/1-20 | 20 mm |
| 6041090032 | GN 1/1-40 | 40 mm |
| 6041090024 | GN 1/1-65 | 65 mm |
| 6041090014 | GN 1/1-100 | 100 mm |
| 6041090013 | GN 1/1-150 | 150 mm |
| 6041090033 | GN 1/1-200 | 200 mm |

GN 2/3 325 X 354

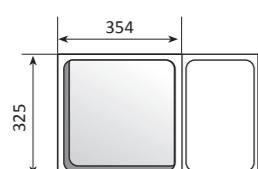

| | | |
|------------|------------|--------|
| 6041090034 | GN 2/3-20 | 20 mm |
| 6041090035 | GN 2/3-40 | 40 mm |
| 6041090036 | GN 2/3-65 | 65 mm |
| 6041090037 | GN 2/3-100 | 100 mm |
| 6041090038 | GN 2/3-150 | 150 mm |
| 6041090039 | GN 2/3-200 | 200 mm |

GN 1/2 325 X 265

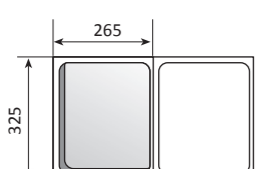

| | | |
|------------|------------|--------|
| 6041090040 | GN 1/2-20 | 20 mm |
| 6041090041 | GN 1/2-40 | 40 mm |
| 6041090006 | GN 1/2-65 | 65 mm |
| 6041090022 | GN 1/2-100 | 100 mm |
| 6041090017 | GN 1/2-150 | 150 mm |
| 6041090042 | GN 1/2-200 | 200 mm |

GN 1/3 325 X 176

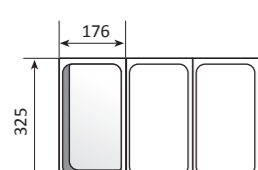

| | | |
|------------|------------|--------|
| 6041090043 | GN 1/3-20 | 20 mm |
| 6041090003 | GN 1/3-40 | 40 mm |
| 6041090044 | GN 1/3-65 | 65 mm |
| 6041090007 | GN 1/3-100 | 100 mm |
| 6041090009 | GN 1/3-150 | 150 mm |
| 6041090008 | GN 1/3-200 | 200 mm |

GN 1/4 162 X 265

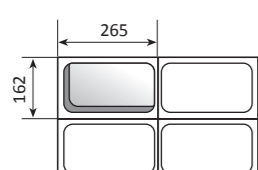

| | | |
|------------|------------|--------|
| 6041090045 | GN 1/4-20 | 20 mm |
| 6041090010 | GN 1/4-40 | 40 mm |
| 6041090046 | GN 1/4-65 | 65 mm |
| 6041090018 | GN 1/4-100 | 100 mm |
| 6041090021 | GN 1/4-150 | 150 mm |
| 6041090047 | GN 1/4-200 | 200 mm |

GN 1/6 176 X 162

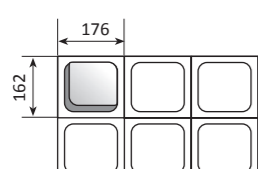

| | | |
|------------|------------|--------|
| 6041090023 | GN 1/6-65 | 65 mm |
| 6041090011 | GN 1/6-100 | 100 mm |
| 6041090012 | GN 1/6-150 | 150 mm |
| 6041090048 | GN 1/6-200 | 200 mm |

| MESAS SERIE SNACK SNACK COUNTERS RANGE MEUBLES SNACK ET FMR | DESCRIPCIÓN DESCRIPTION DESCRIPTION | PARA MODELO SUITABLE FOR MODEL POUR MODÈLE | |
|---|---|---|-----------|
| | D2001R002 | Parrilla acero plastificado centro 405x525 405X525 central laminated shelf Clayettes inox plastifié centre 405x525 | BMR - CMR |
| | 6027050012 | Parrilla acero inoxidable centro 405x525 405X525 central staint steel shelf Clayettes inox plastifié centre 405x525 | BMR - CMR |
| | D2001R001 | Parrilla acero plastificado lateral 405x460 405X460 lateral laminated shelf Clayettes inox plastifié côté 405x460 | BMR - CMR |
| | 6027050018 | Parrilla acero inoxidable lateral 405x460 405X460 lateral staint steel shelf Clayettes inox plastifié côté 405x460 | BMR - CMR |

| GN Y 600X400 | DESCRIPCIÓN DESCRIPTION DESCRIPTION | PARA MODELO SUITABLE FOR MODEL POUR MODÈLE | |
|--------------|---|--|-----|
| | 270100001 | Parrilla acero plastificado GN 1/1 GN 1/1 laminated shelf Clayettes inox plastifié GN 1/1 | BRG |
| | 270500001 | Parrilla acero inoxidable GN 1/1 GN 1/1 staint steel shelf Clayettes inox GN 1/1 | BRG |
| | 270100002 | Parrilla acero plastificado GN 2/1 GN 1/1 laminated shelf Clayettes inox plastifié GN 1/1 | ARG |
| | 270500002 | Parrilla acero inoxidable GN 2/1 GN 1/1 staint steel shelf Clayettes inox GN 1/1 | ARG |
| | 270100004 | Parrilla acero plastificado 600X400 600X400 laminated shelf Clayettes inox plastifié 600X400 | AEP |
| | 270500003 | Parrilla acero inoxidable 600X400 600X400 staint steel shelf Clayettes inox 600X400 | AEP |

| ARMARIOS SERIE SNACK SNACK CABINETS RANG ARMOIRES RÉFRIGÉRÉES SNACK ET EUROSNAK | DESCRIPCIÓN DESCRIPTION DESCRIPTION | PARA MODELO SUITABLE FOR MODEL POUR MODÈLE | |
|---|---|--|----------------|
| | D0101R002 | Parrilla acero plastificado 560x542 560X542 laminated shelf Clayettes inox plastifié 560x542 | AR |
| | D0101R003 | Parrilla acero inoxidable 560x542 560X542 staint steel shelf Clayettes inox 560x542 | AR |
| | 6027010086 | Parrilla intermedia acero plastificado 160x500 160X500 intermediate laminated shelf Clayettes inox plastifié 160x500 | AR |
| | 6027050014 | Parrilla intermedia acero inoxidable 160x500 160X500 intermediate staint steel shelf Clayettes inox 160x500 | AR |
| | 270100003 | Parrilla acero plastificado 485X530 485X530 laminated shelf Clayettes inox plastifié 485X530 | AR/ACR/ACE-125 |

| ARMARIOS EUROSNAK EUROSNAK CABINETS EUROSNAK CABINETS | DESCRIPCIÓN DESCRIPTION DESCRIPTION | PARA MODELO SUITABLE FOR MODEL POUR MODÈLE | |
|---|---|--|----------------|
| | 6027010097 | Parrilla acero plastificado 480x450 480X450 laminated shelf Clayettes inox plastifié 480x450 | AER, AERE, AEC |
| | 270100003 | Parrilla acero plastificado 485X530 485X530 laminated shelf Clayettes inox plastifié 485X530 | AR/ACR/ACE-125 |

| FLUORESCENTES PARA CARNE FLUORESCENT MEAT VIANDE FLUORESCENT | DESCRIPCIÓN DESCRIPTION DESCRIPTION | PARA MODELO SUITABLE FOR MODEL POUR MODÈLE |
|--|---|--|
| | Fluorescentes para carne 30 W Fluorescent meat Viande fluorescent | |
| | Fluorescentes para carne 36 W Fluorescent meat Viande fluorescent | |

| MESAS SERIE SNACK SNACK COUNTERS RANGE MEUBLES SNACK | DESCRIPCIÓN DESCRIPTION DESCRIPTION | PARA MODELO SUITABLE FOR MODEL POUR MODÈLE |
|--|---|--|
| | 6027010055 Parrilla acero plastificado Laminated steel shelf Clayettes inox plastifié | EHB-150 |
| | 6027010052 Parrilla acero plastificado Laminated steel shelf Clayettes inox plastifié | EHB-250 EHBS-250 |
| | 6027010068 Parrilla acero plastificado Laminated steel shelf Clayettes inox plastifié | EHB-350 |
| | 6027010042 Parrilla acero plastificado Laminated steel shelf Clayettes inox plastifié | DRVCS-1000 |

| BOTELLEROS Y ESCARCHACOPAS BOTTLE COOLERS AND GLASS FROSTER REFROIDISSEUR A VERRES | DESCRIPCIÓN DESCRIPTION DESCRIPTION | PARA MODELO SUITABLE FOR MODEL POUR MODÈLE |
|--|---|--|
| | 6027010067 Parrilla acero plastificado 528x440 528x440 laminated shelf Clayettes inox plastifié 528x440 | DEC-140 |
| | 6027010025 Parrilla acero plastificado 385x395 385x395 laminated shelf Clayettes inox plastifié 385x395 | DEC-85 - DEE-85 |
| | 6027130008 Parrilla acero plastificado 440x276 440x276 laminated shelf Clayettes inox plastifié 440x276 | EBEG |
| | 6027130003 Separador interior acero plastificado 500x435 500x435 laminated shelf interior separator Separateur interieur en acier plastifié 500x435 | EB |

| BANDEJAS DE PLÁSTICO CONTAINERS CONTENEURS EN PLASTIQUE | DESCRIPCIÓN DESCRIPTION DESCRIPTION | PARA MODELO SUITABLE FOR MODEL POUR MODÈLE |
|---|--|--|
| | 6003050007 Cajón 530x460x100 530x460x100 container Conteneur 530x460x100 | ADP-DDP-140 |
| | 6003050006 Cajón 530x540x100 530x540x100 container Conteneur 530x540x100 | ARM-ARGP-ARGM |
| | 6003010077 Cajón 600x400x120 600x400x120 container Conteneur 600x400x120 | AEP |
| | 6003010430 Cajón 410x458x143 410x458x143 container Conteneur 410x458x143 | AEP-400 |
| | 6003010079 Cajón 600x400x70 600x400x70 container Conteneur 600x400x70 | MP-MR |

| BARRAS CARNICERAS MEAT BARS BARRES BOUCHERS | DESCRIPCIÓN DESCRIPTION DESCRIPTION | PARA MODELO SUITABLE FOR MODEL POUR MODÈLE |
|---|--|--|
| | A165090005 Juego barras carniceras armarios snack Snack cabinets meat bars Kit barres bouchers armoire snack | Todos excepto gama 55 y 125 All except 55 and 125 range Tous les modèles sauf series 55 et 125 |
| | A165090003 Juego barras carniceras armarios GN 2/1 GN 2/1 cabinets meat bars Kit barres bouchers armoire snack GN 2/1 | |
| | A165090006 Juego barras carniceras armarios Eurosnack Eurosnack cabinets meat bars Kit barres bouchers armoire snack Eurosnack | Todos excepto gama 55 y 125 All except 55 and 125 range Tous les modèles sauf series 55 et 125 |
| | 621800006 Juego barras carniceras armarios snack 125 Snack 125 cabinets meat bars | ACR/ACC/ACRV-125 |
| | A165090008 Juego barras carniceras armarios snack Snack cabinets meat bars Kit barres bouchers armoire snack | ACR/ACC/ACRV-55 |
| | A165090009 Juego barras carniceras armarios GN 1/1 GN 1/1 cabinets meat bars Kit barres bouchers armoire snack GN 1/1 | |

| GUÍAS PARA PARRILLAS Y BANDEJAS SLIDES FOR SHELF AND TRAYS GUIDES POUR CLAYETTES ET CONTENEURS | DESCRIPCIÓN DESCRIPTION DESCRIPTION | PARA MODELO SUITABLE FOR MODEL POUR MODÈLE |
|--|--|--|
| | 340500007 Par de guías en "U", longitud 519 mm. 519 mm. length slides set, "U" design Paire de guides en "U", largeur 519 mm. | ARSP |
| | 340500001 Par de guías en "U", longitud 549 mm. 549 mm. length slides set, "U" design Paire de guides en "U", largeur 549 mm. | Armarios gama 125 y 50 |
| | 340500006 Par de guías en "U", longitud 562 mm. 562 mm. length slides set, "U" design Paire de guides en "U", largeur 562 mm. | Mesas GN 1/1 - ACM |
| | 340500002 Par de guías en "U", longitud 613 mm. 613 mm. length slides set, "U" design Paire de guides en "U", largeur 613 mm. | MFCG-ARGP-AR-55 |
| | 340500008 Par de guías en "U", longitud 662 mm. 662 mm. length slides set, "U" design Paire de guides en "U", largeur 662 mm. | Armarios GN 2/1 |
| | 6033050026 Par de guías en "L", longitud 485 mm. 485 mm. length slides set, "L" design Paire de guides en "L", largeur 485 mm. | ARP-750 |
| | 340500003 Par de guías en "L", longitud 613 mm. 613 mm. length slides set, "L" design Paire de guides en "L", largeur 613 mm. | AR-55/AEP/ARP AEPE-55 |
| | 340500004 Par de guías en "L", longitud 649 mm. 649 mm. length slides set, "L" design Paire de guides en "L", largeur 649 mm. | Mesas 600x400 |
| | 340500009 Par de guías en "L", longitud 662 mm. 662 mm. length slides set, "L" design Paire de guides en "L", largeur 662 mm. | ARP/ACP-750 ARP/ACP-1002 |

| JUEGO DE RUEDAS CASTORS SETS ROULETTES | DESCRIPCIÓN DESCRIPTION DESCRIPTION | PARA MODELO SUITABLE FOR MODEL POUR MODÈLE |
|--|--|--|
| | 611100001 Juego 4 ruedas (2 con freno + 2 sin freno) 4 castors set (2 with brakes + 2 without brakes) 4 Roulettes (2 avec freins+ 2 sans freins) | |
| | 611100002 Juego 6 ruedas(3 con freno + 3 sin freno) 6 castors set (3 with brakes + 3 without brakes) 6 Roulettes (3 avec freins+ 3 sans freins) | |

| PATAS INOXIDABLES STAINLESS STEEL FEETS PIEDS INOX | DESCRIPCIÓN DESCRIPTION DESCRIPTION | PARA MODELO SUITABLE FOR MODEL POUR MODÈLE |
|--|---|--|
| | 342500003 Patas inox 125 - 200 mm. 125 - 200 mm. stainless steel feet Pieds inox 125 - 200 mm | |
| | 6007050079 Patas inox 95 - 125 mm. 95 - 125 mm. stainless steel feet Pieds inox 95 - 125 mm. | BCR |
| | 6007050031 Patas botellero Bottle cooler feet Pieds refroidisseur à bouteilles | EB |

| CERRADURAS LOCKS FERMETURE PORTES | DESCRIPCIÓN DESCRIPTION DESCRIPTION | PARA MODELO SUITABLE FOR MODEL POUR MODÈLE |
|---|---|--|
| | A169220005 Conjunto cerradura puerta, apertura a izquierda Left hand opening lock set kit fermeture porte, gauche | Mesas frías Refrigerated counters Meuble réfrigéré |
| | A169220006 Conjunto cerradura puerta, apertura a derecha Right hand opening lock set kit fermeture porte, droite | Mesas frías Refrigerated counters Meuble réfrigéré |
| | A169220005 Conjunto cerradura puerta, apertura a izquierda Left hand opening lock set kit fermeture porte, gauche | Armarios, parte superior Cabinets, upper side Armoire haut |
| | A169220006 Conjunto cerradura puerta, apertura a derecha Right hand opening lock set kit fermeture porte, droite | Armarios, parte superior Cabinets, upper side Armoire haut |
| | A169220008 Conjunto cerradura puerta, apertura a izquierda Left hand opening lock set kit fermeture porte, gauche | Armarios, puerta inferior izq. Cabinets, small left door Armoire porte bas gauche |
| | A169220007 Conjunto cerradura puerta, apertura a derecha Right hand opening lock set kit fermeture porte, droite | Armarios, puerta inferior der. Cabinets, small right door Armoire porte bas droite |

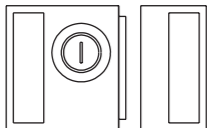
| CERRADURAS LOCKS FERMETURE PORTES | DESCRIPCIÓN DESCRIPTION DESCRIPTION | PARA MODELO SUITABLE FOR MODEL POUR MODÈLE |
|---|---|--|
|  | 6033010075 Cerradura lateral Side lock Fermeture côté | DEC, DECC, DECCM, DEM, DECP |

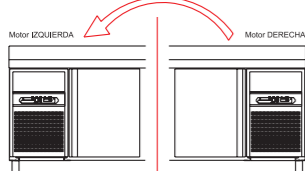
| GRUPO LADO IZQUIERDO ENGINE IN LEFT SIDE GROUPE CÔTÉ DROITE | DESCRIPCIÓN DESCRIPTION DESCRIPTION | PARA MODELO SUITABLE FOR MODEL POUR MODÈLE |
|---|--|--|
|  | Incremento motor lado izquierdo Engine in left side Augmentation prix moteur côté gauche | Mesas frías sin fregadero Snack counters without sink Meubles sans évier |
| | Incremento motor lado izquierdo Engine in left side Augmentation prix moteur côté gauche | Mesas frías con fregadero Snack counters with sink Meubles avec évier |

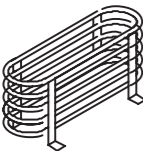
| CONDENSACIÓN MIXTA AIRE - AGUA MIXED CONDENSATION AIR - WATER CONDENSATION MIXTE AIR-EAU | DESCRIPCIÓN DESCRIPTION DESCRIPTION | PARA MODELO SUITABLE FOR MODEL POUR MODÈLE |
|--|--|--|
|  | Condensación mixta aire-agua Mixer condenser unit air-water Condensation mixte air-eau | Mesas y Armarios Refrigerados, Vitrina cerrada y mural Refrigerated counters and cabinets, closed and mural showcase Meubles et Armoires réfrigérés, Vitrine fermée et mureaux |

| SEPARADOR AMBIENTE TEMPERATURE SEPARATOR SÉPARATEUR DE TEMPÉRATURE | DESCRIPCIÓN DESCRIPTION DESCRIPTION | PARA MODELO SUITABLE FOR MODEL POUR MODÈLE |
|---|---|--|
|  | Separador ambiente para kit unión. Environment for binding separator kit L'environnement pour le kit séparateur contraignant. | indique modelo: VE-8 / VE-9 / VE-10 model indicate: VE-8 / VE-9 / VE-10 modèle indiquent: VE-8 / VE-9 / VE-10 |

| SEPARADOR GENERO PRODUCT SEPARATOR SÉPARATEUR PRODUIT | DESCRIPCIÓN DESCRIPTION DESCRIPTION | PARA MODELO SUITABLE FOR MODEL POUR MODÈLE |
|---|--|--|
|  | Separador para genero. Product separator Séparateur produit. | indique modelo: VE-8 / VE-9 / VE-10 model indicate: VE-8 / VE-9 / VE-10 modèle indiquent: VE-8 / VE-9 / VE-10 |

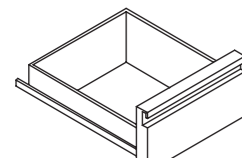
| CAJONES AUXILIARES NEUTRAL DRAWERS TIROIRS AUXILIAIRES | DESCRIPCIÓN DESCRIPTION DESCRIPTION | PARA MODELO SUITABLE FOR MODEL POUR MODÈLE |
|---|--|--|
|  | M269130007 Cajón neutro (repuesto) Neutral drawers (spare) Tiroir neutre (rechange) | CMC |
| | M169130024 Cajón neutro CMR motor lado derecho (repuesto) FMR right hand engine drawer (spare) Tiroir neutre droite (rechange) | CMR - CMC |
| | M169130025 Cajón neutro CMR motor lado izquierdo (repuesto) FMR right hand engine drawer (spare) Tiroir neutre gauche (rechange) | CMR - CMC |

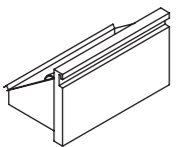
| TOLVA PARA CAFÉ CHUTE DRAWER FOR COFFEE WASTE TRÉMIE POUR CAFÉ | DESCRIPCIÓN DESCRIPTION DESCRIPTION | PARA MODELO SUITABLE FOR MODEL POUR MODÈLE |
|---|---|--|
|  | M269170005 Cajón tolva especial posos café Drawer for coffee waste Spécial café trémie lie tiroir | CMC |
| | M169170014 Cajón tolva especial posos café, CMR motor derecho. (repuesto) Drawer for coffee waste, right hand engine CMR (spare) Tiroir à marc de café spécial trémie, moteur droite CMR. (Remplacement) | CMR - CMC |
| | M169170015 Cajón tolva especial posos café, CMR motor izquierdo. (repuesto) Drawer for coffee waste, left hand engine CMR (spare) Tiroir à marc de café spécial trémie, moteur gauche CMR. (Remplacement) | CMR - CMC |

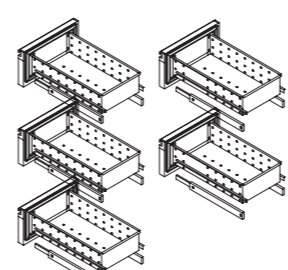
| CAJONERAS REFRIGERADAS REFRIGERATED DRAWERS SET TIROIRS | DESCRIPCIÓN DESCRIPTION DESCRIPTION | PARA MODELO SUITABLE FOR MODEL POUR MODÈLE |
|---|---|--|
|  | M169120152 Kit cajonera refrigerada 100+100 GN 1/1 GN 1/1 100+100 refrigerated drawers set Kit de tiroir réfrigéré 100+100 GN 1/1 | BCR-DMF-MS-MP100/140 |
| | M169120153 Kit cajonera refrigerada 100+100+100 GN 1/1 GN 1/1 100+100+100 refrigerated drawers set Kit de tiroir réfrigéré 100+100+100 GN 1/1 | Mesas GN 1/1 refrigeración Refrigerated GN 1/1 counters |
| | M169120154 Kit cajonera refrigerada 100+300 GN 1/1 GN 1/1 100+300 refrigerated drawers set Kit de tiroir réfrigéré 100+300 GN 1/1 | Mesas GN 1/1 refrigeración Refrigerated GN 1/1 counters |
| | M169120155 Kit cajonera refrigerada 200+200 GN 1/1 (lado grupo) GN 1/1 200+200 refrigerated drawers set (engine side) Kit de tiroir réfrigéré 100+300 GN 1/1 (groupe lateral) | Mesas GN 1/1 refrigeración Refrigerated GN 1/1 counters |
| | M169120156 Kit cajonera refrigerada 200+200 GN 1/1 GN 1/1 200+200 refrigerated drawers set Kit de tiroir réfrigéré 200+200 GN 1/1 | Mesas GN 1/1 refrigeración Refrigerated GN 1/1 counters |
| | M169120157 Kit cajonera refrigerada 100+100+100 snack Snack 100+100+100 refrigerated drawers set Kit de tiroir réfrigéré 100+100+100 snack | Mesas snack refrigeración Refrigerated snack counters |
| | M169120158 Kit cajonera refrigerada 100+300 snack Snack 100+300 refrigerated drawers set Kit de tiroir réfrigéré 100+300 snack | Mesas snack refrigeración Refrigerated snack counters |
| | M169120159 Kit cajonera refrigerada 200+200 snack (lado contra-grupo) Snack 200+200 refrigerated drawers set (opposite engine side) Kit de tiroir réfrigéré 200+200 snack (groupe oppose) | Mesas snack refrigeración Refrigerated snack counters |
| | M169120160 Kit cajonera refrigerada 200+200 snack (lado grupo) Snack 200+200 refrigerated drawers set (engine side) Kit de tiroir réfrigéré 200+200 snack (groupe lateral) | Mesas snack refrigeración Refrigerated snack counters |
| | M169120161 Kit cajonera refrigerada 200+200 snack Snack 200+200 refrigerated drawers set Kit de tiroir réfrigéré 200+200 snack | Mesas snack refrigeración Refrigerated snack counters |
| | M169120162 Kit cajonera refrigerada 170+170+170 frente mostrador Back bar 170+170+170 refrigerated drawers set Kit de tiroir réfrigéré 170+170+170 CMR | Frente mostrador refrigerado Back-bar |
| | M169120163 Kit cajonera refrigerada 170+450 frente mostrador Back bar 170+450 refrigerated drawers set Kit de tiroir réfrigéré 170+450 CMR | Frente mostrador refrigerado Back-bar |
| | M169120164 Kit cajonera refrigerada 300+300 frente mostrador (lado contra grupo) Back bar 300+300 refrigerated drawers set (opposite engine side) Kit de tiroir réfrigéré 170+450 CMR (groupe oppose) | Frente mostrador refrigerado Back-bar |
| | M169120165 Kit cajonera refrigerada 300+300 frente mostrador (lado grupo) Back bar 300+300 refrigerated drawers set (engine side) Kit de tiroir réfrigéré 300+300 CMR (groupe lateral) | Frente mostrador refrigerado Back-bar |
| | M169120166 Kit cajonera refrigerada 300+300 frente mostrador Back bar 300+300 refrigerated drawers set Kit de tiroir réfrigéré 300+300 CMR | Frente mostrador refrigerado Back-bar |

| JUEGOS BISAGRAS HINGES SETS KIT CHARNIÈRES | DESCRIPCIÓN DESCRIPTION DESCRIPTION | PARA MODELO SUITABLE FOR MODEL POUR MODÈLE |
|--|---|--|
| | M169090003 Juego bisagras apertura izquierda mesas frías Hinge set left opening door refrigerated counter Jeu de charnières ouverture gauche meubles réfrigérés | Mesas frías Refrigerated counters Meubles réfrigérés |
| | M169090004 Juego bisagras apertura derecha mesas frías Hinge set right opening door refrigerated counter Jeu de charnières ouverture droite meubles réfrigérés | Mesas frías Refrigerated counters Meubles réfrigérés |

| JUEGOS BISAGRAS HINGES SETS KIT CHARNIÈRES | DESCRIPCIÓN DESCRIPTION DESCRIPTION | PARA MODELO SUITABLE FOR MODEL POUR MODÈLE |
|--|---|--|
| | A169090010 Juego bisagras apertura izquierda armarios Hinge set left opening door refrigerated cabinets Jeu de charnières ouverture gauche armoires | Armarios Cabinets Armoires |
| | A169090011 Juego bisagras apertura derecha armarios Hinge set right opening door refrigerated cabinets Jeu de charnières ouverture droite armoires | Armarios Cabinets Armoires |

| JUEGOS BISAGRAS HINGES SETS KIT CHARNIÈRES | DESCRIPCIÓN DESCRIPTION DESCRIPTION | PARA MODELO SUITABLE FOR MODEL POUR MODÈLE |
|--|---|--|
| | A169090012 Juego bisagra puerta intermedia lado derecho Right lide intermediate hinge set Jeu de charnières ouverture droite | Armarios Cabinets Armoires |
| | A169090013 Juego bisagra puerta intermedia lado izquierdo Left lide intermediate hinge set Jeu de charnières ouverture gauche | Armarios Cabinets Armoires |



www.docriluc.com

