

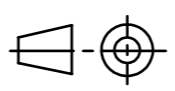

CV018-2T

Notes:

| | | | |
|---|---------------------------------------|-------|--|
| | Date | Name |  <small>THE INFORMATION CONTAINED IN THIS DRAWING IS THE SOLE PROPERTY OF CAVANOVA. ANY REPRODUCTION IN PART OR AS A WHOLE WITHOUT THE WRITTEN PERMISSION OF CAVANOVA IS PROHIBITED.</small> |
| Design: | 03/12/2018 | Diego | |
| Checked: | | Diego | |
| Modified: | | Diego | |
| Scale: 1:10 | Part name: CV018-2T | | Top assembly: CV018-2T |
|  | Description: Vinoteca para 18botellas | | Client: |
| | | | Material: |
| | | | Reference: CV018-2T |
| | | | Count: |
| | | | Pages: 1 OF 4 |

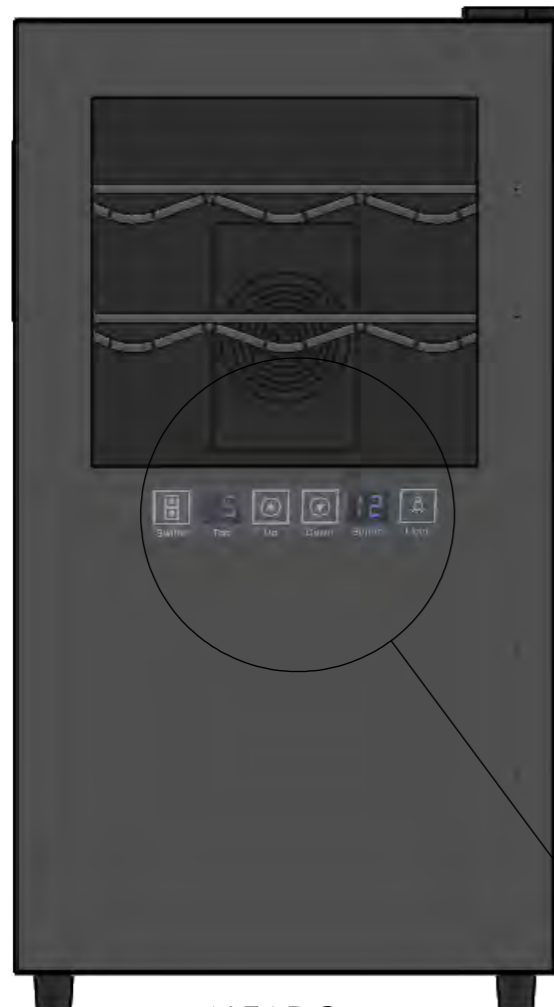

ALZADO

356

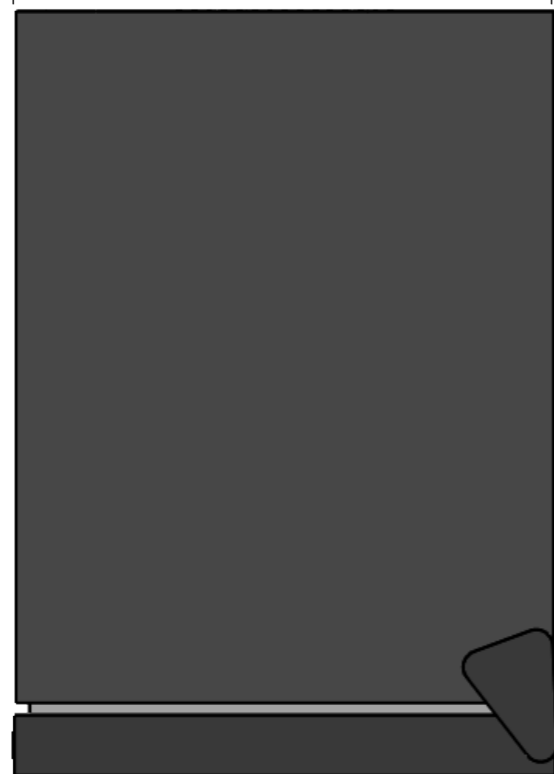

PLANTA

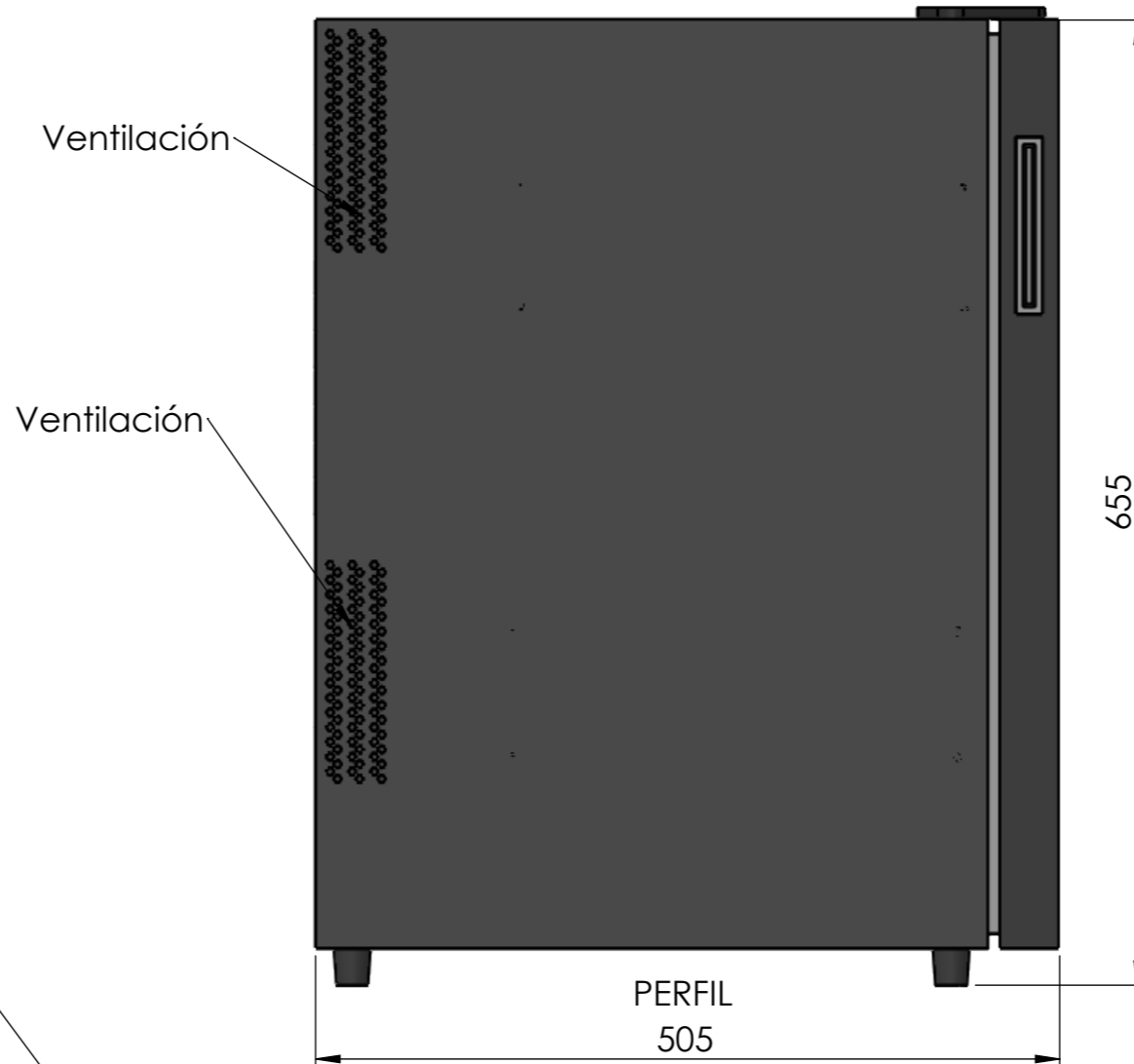

Ventilación

Ventilación

655

PERFIL

505



control táctil
temperatura
y luz

DATOS TÉCNICOS

| | |
|----------------------|------------------|
| Volumen | 48L |
| Botellas | 18 |
| Frecuencia | 50-60hz |
| Consumo | 1(15°C)kw/d |
| Voltaje | 220/240-110/115V |
| Ruido | 38db |
| Humedad interior | >70% RH |
| Sistema de frío | Termoeléctrico |
| Rango de temperatura | 12-18°C/8-18°C |

| | Date | Name |
|-------------|------------------------|-------|
| Design: | 03/12/2018 | Diego |
| Checked: | | Diego |
| Modified: | | Diego |
| Scale: 1:10 | Part name: CV018-2T | |
| Unit: | Top assembly: CV018-2T | |

cavanoval

THE INFORMATION CONTAINED IN THIS DRAWING IS THE SOLE PROPERTY OF CAVANOVA WINE S.L. IN MÁLAGA, SPAIN. ANY REPRODUCTION IN PART OR AS A WHOLE WITHOUT THE WRITTEN PERMISSION OF CAVANOVA WINE S.L. IS PROHIBITED.

Sign:

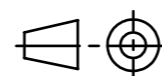

Description:
Vinoteca para 18botellas

Client:

Material:

Reference: CV018-2T

Count:

Pages: 2 OF 4

2 baldas cromadas

2 baldas cromadas

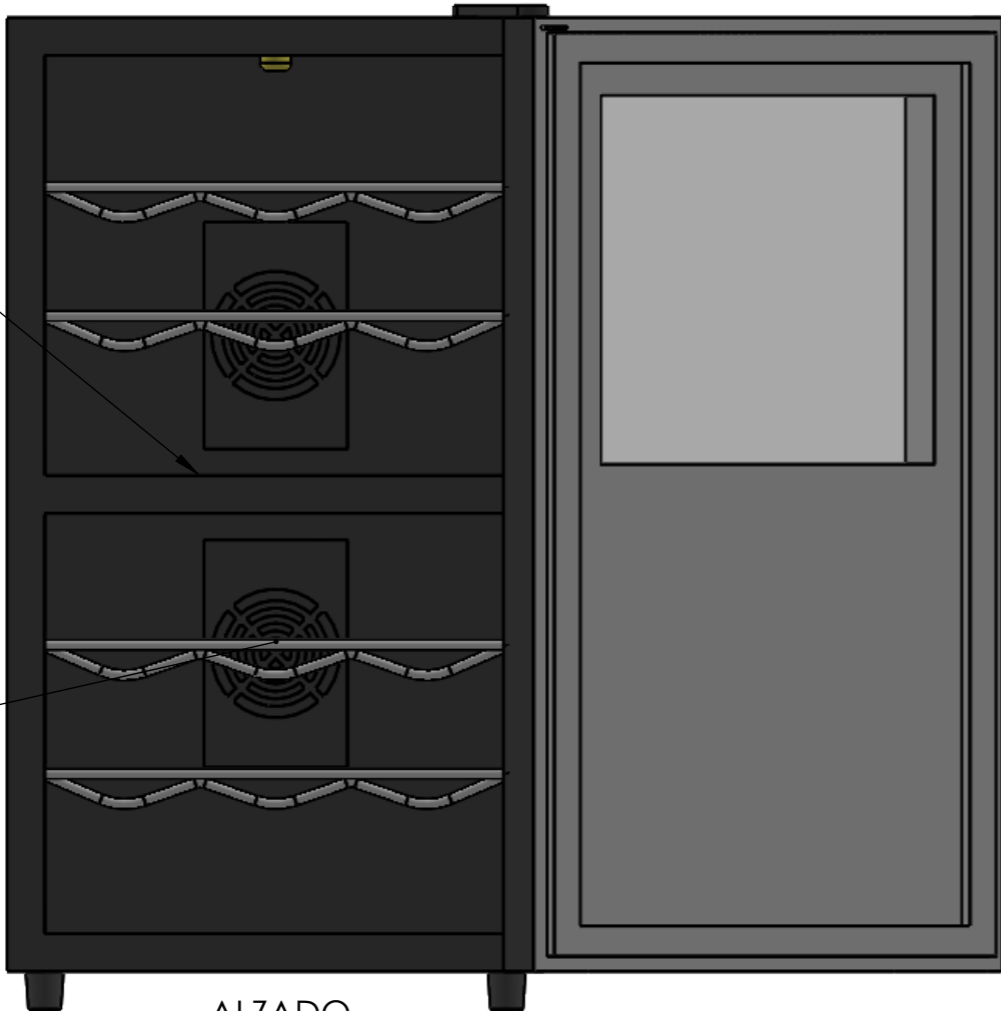

ALZADO

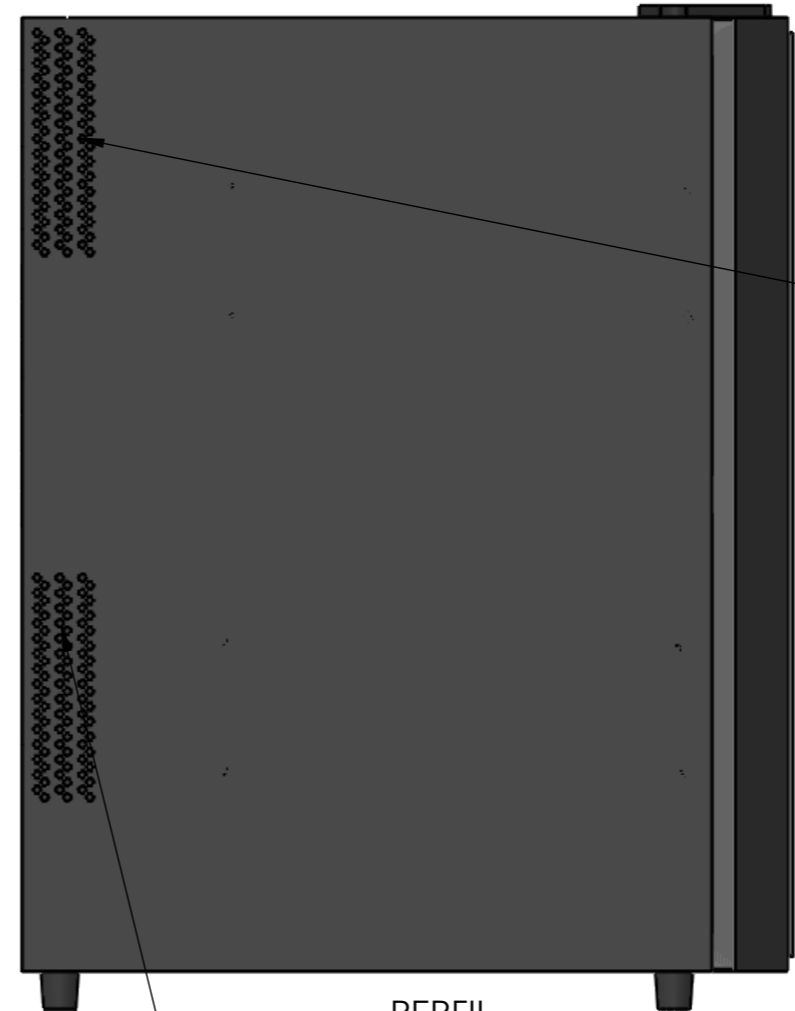

PERFIL

Ventilación

Ventilación

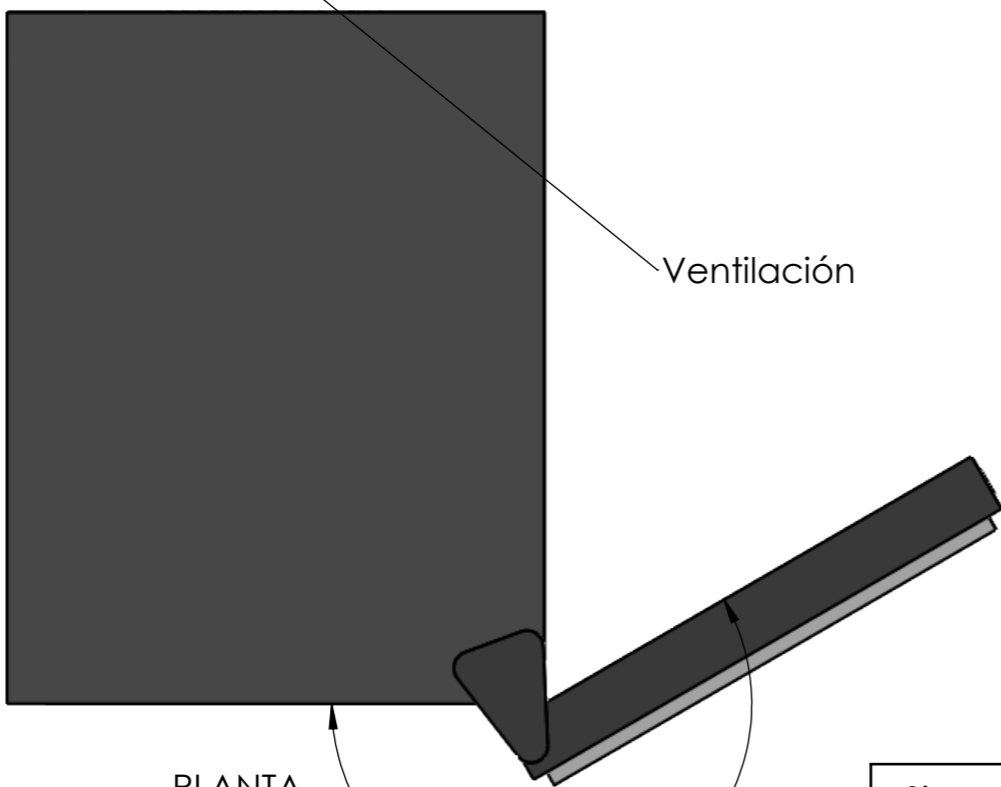
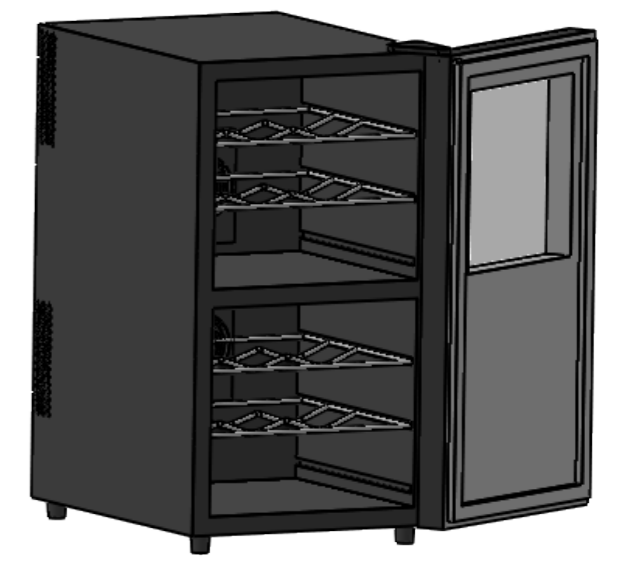

PLANTA

Ventilación

210°max. apertura

DATOS TÉCNICOS

| | |
|----------------------|------------------|
| Volumen | 48L |
| Botellas | 18 |
| Frecuencia | 50-60hz |
| Consumo | 1 (15°C)kw/d |
| Voltaje | 220/240-110/115V |
| Ruido | 38db |
| Humedad interior | >70% RH |
| Sistema de frío | Termoeléctrico |
| Rango de temperatura | 12-18°C/8-18°C |

| | Date | Name |
|-------------|------------------------|-------|
| Design: | 03/12/2018 | Diego |
| Checked: | | Diego |
| Modified: | | Diego |
| Scale: 1:10 | Part name: CV018-2T | |
| Unit: | Top assembly: CV018-2T | |

cavanoa

THE INFORMATION CONTAINED IN THIS DRAWING IS THE SOLE PROPERTY OF CAVANOVA WINE S.L. IN MÁLAGA, SPAIN. ANY REPRODUCTION IN PART OR AS A WHOLE WITHOUT THE WRITTEN PERMISSION OF CAVANOVA WINE S.L. IS PROHIBITED.

Sign:

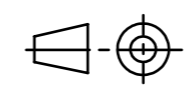

Description:
Apertura de puerta

| |
|---------------------|
| Client: |
| Material: |
| Reference: CV018-2T |
| Count: |
| Pages: 3 OF 4 |

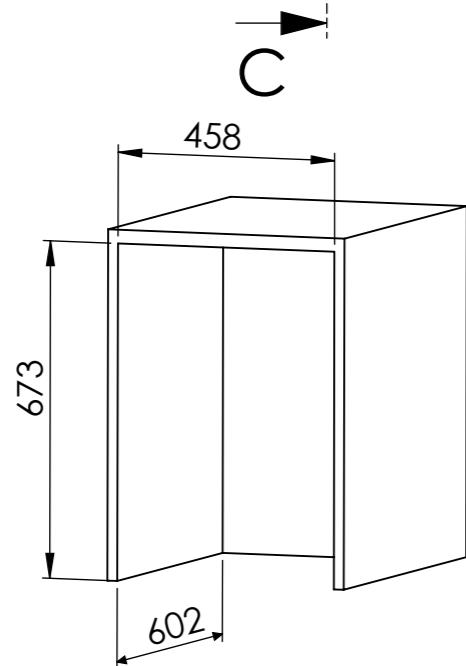
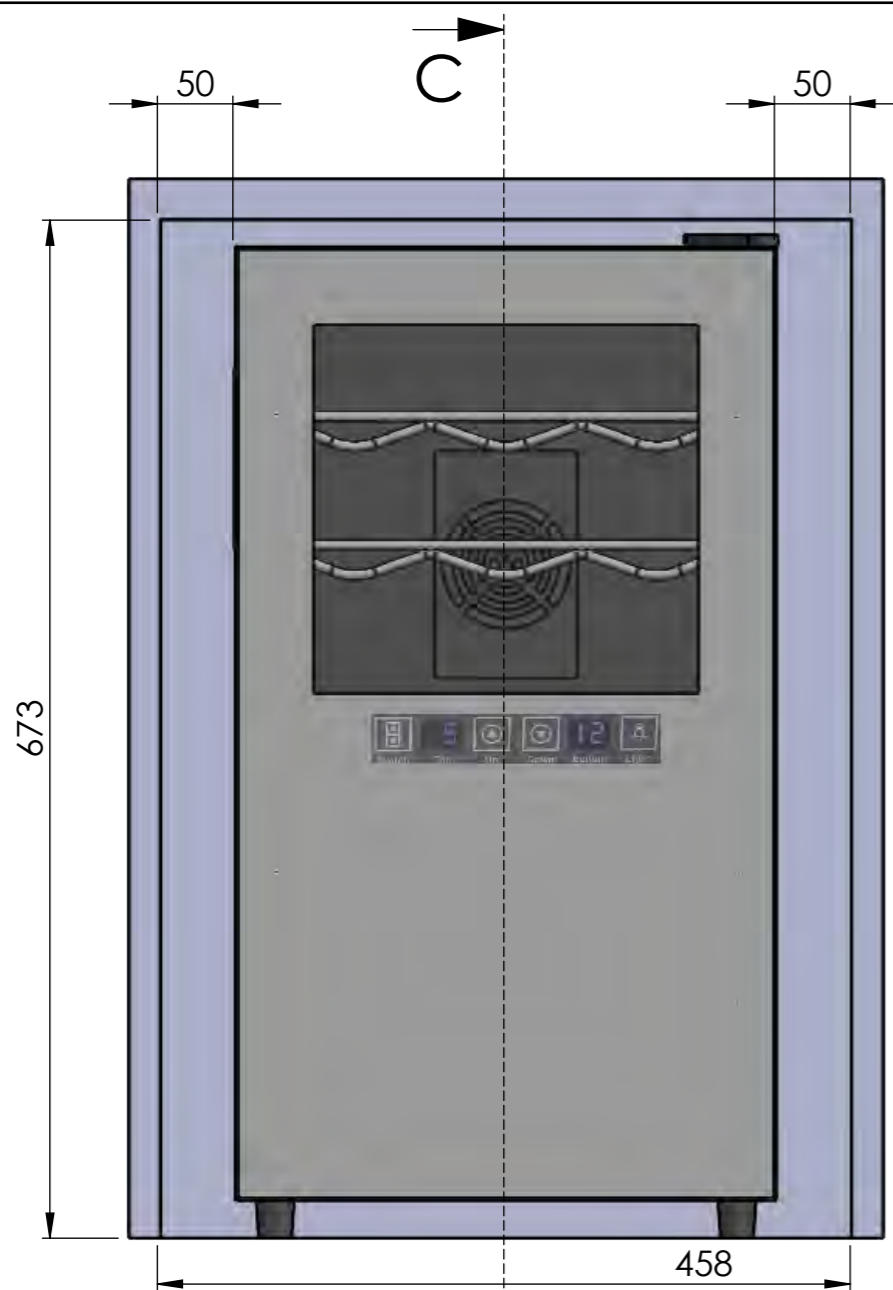

Medidas para hueco

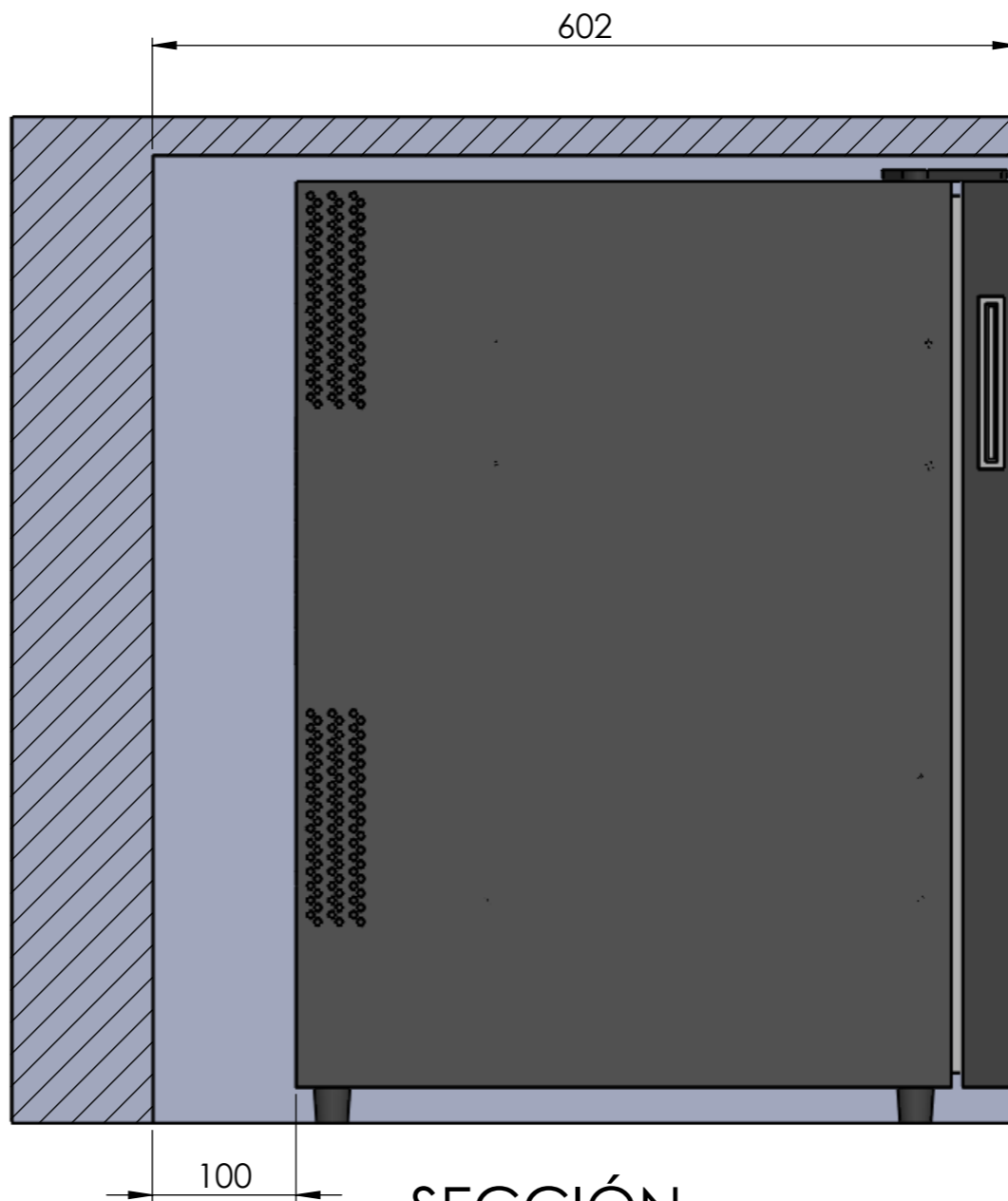

SECCIÓN C-C
ESCALA 1 : 5

| MEDIDAS RECOMENDADAS | |
|----------------------|-------------------------|
| ALTURA | 673mm mín |
| PROFUNDIDAD | 100mm mín (libre atrás) |
| ANCHURA | 50mm por cada lado |

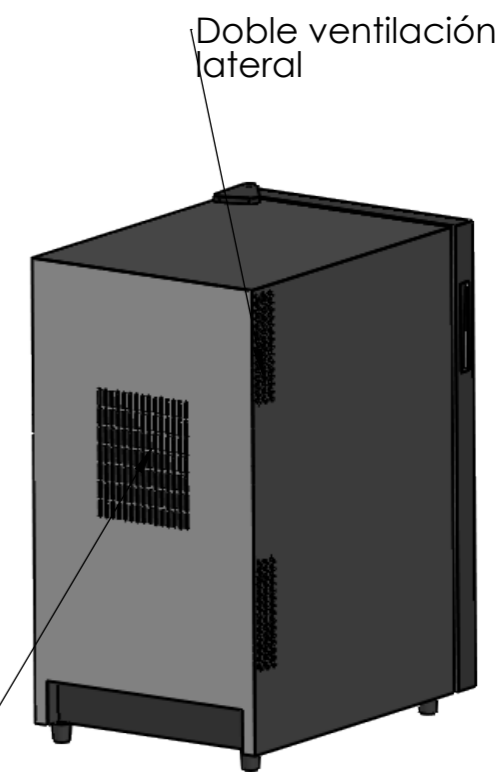

NO OBSTRUIR VENTILACIÓN

Sign:

| Date | Name |
|--|-----------------------------|
| 09/10/2018 | Diego |
| | Diego |
| | Diego |
| Scale: 1:10 | Part name: CV018-2T-ENTORNO |
| Unit: mm | Top assembly: CV018-2T |
| Description: Empotramiento del equipo (built-in) | |

| | |
|---|------------------|
| cavanova | |
| THE INFORMATION CONTAINED IN THIS DRAWING IS THE SOLE PROPERTY OF CAVANOVA WINE S.L. IN MÁLAGA, SPAIN. ANY REPRODUCTION IN PART OR AS A WHOLE WITHOUT THE WRITTEN PERMISSION OF CAVANOVA WINE S.L. IS PROHIBITED. | |
| Client: | Cavanova |
| Material: | Varios |
| Reference: | CV018-2T-ENTORNO |
| Count: | |
| Pages: | 4 OF 4 |