

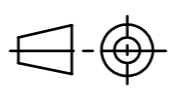

CV004

Notes:

	Date	Name	 <small>THE INFORMATION CONTAINED IN THIS DRAWING IS THE SOLE PROPERTY OF CAVANOVA. ANY REPRODUCTION IN PART OR AS A WHOLE WITHOUT THE WRITTEN PERMISSION OF CAVANOVA IS PROHIBITED.</small>
Design:	03/12/2018	Diego	
Checked:		Diego	
Modified:		Diego	
Scale: 1:10	Part name: CV004		Top assembly: CV004
	Description:		Client:
	Vinoteca para 4 botellas		Material:
			Reference: CV004
			Count:
		Pages: 1 OF 4	

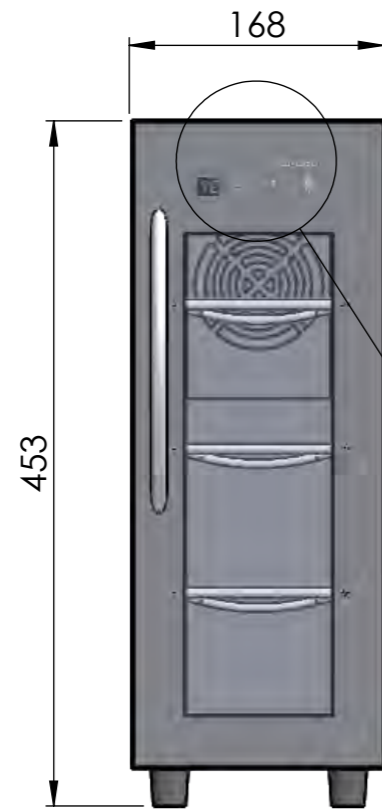

Alzado

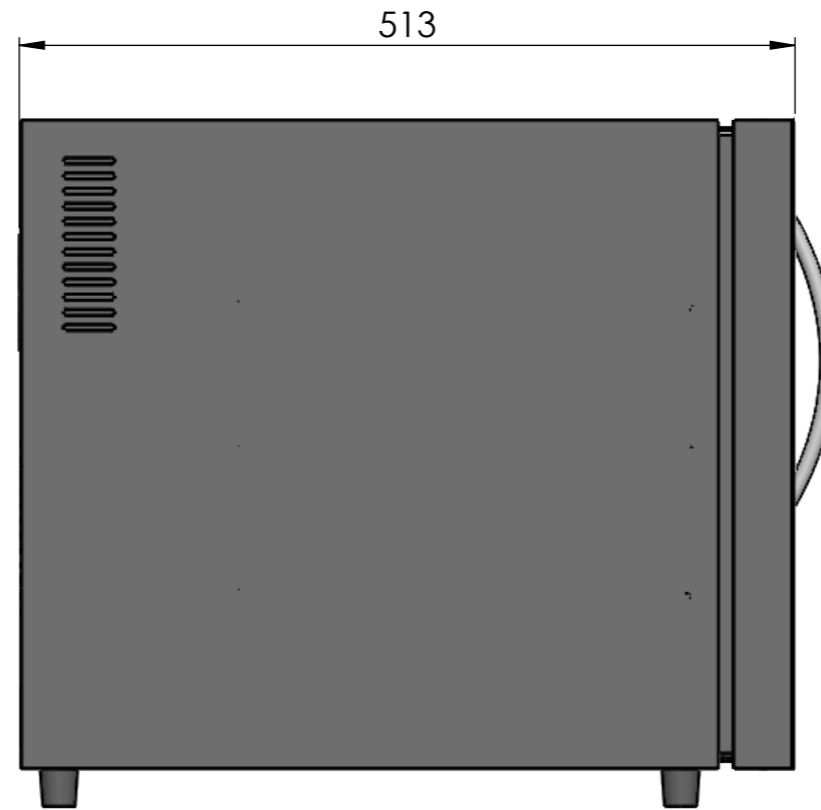

Perfil

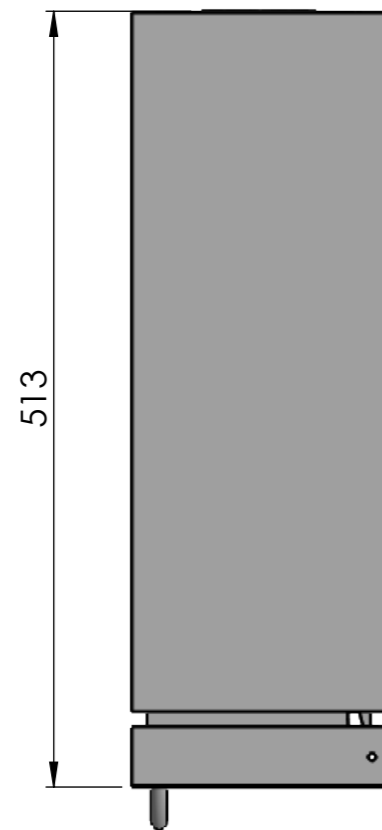

Planta

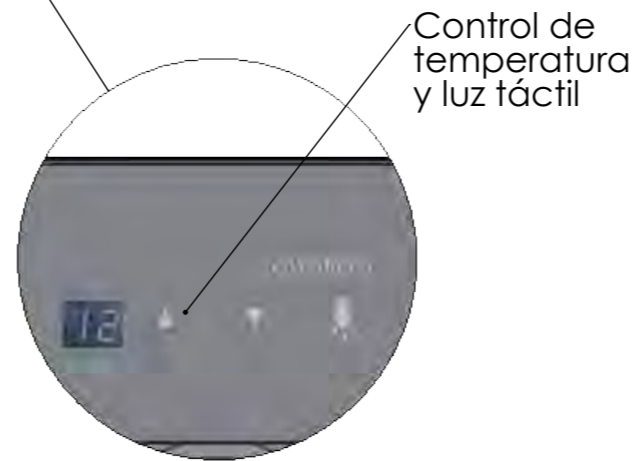

Control de temperatura y luz táctil

DATOS TÉCNICOS	
VOLUMEN	12L
Rango de temperatura	7-18°C
Botellas	4
Frecuencia	50-60Hz
Consumo	0.35(15°C)
Voltaje	220/240-110/115 V
Ruido	38db
Humedad interior	>70%RH
Sistema de frío	Termoeléctrico

Date	Name	cavanova	
Design: 03/12/2018	Diego	<small>THE INFORMATION CONTAINED IN THIS DRAWING IS THE SOLE PROPERTY OF CAVANOVA WINE S.L. IN MÁLAGA, SPAIN. ANY REPRODUCTION IN PART OR AS A WHOLE WITHOUT THE WRITTEN PERMISSION OF CAVANOVA WINE S.L. IS PROHIBITED.</small>	
Checked:	Diego		
Modified:	Diego		
Scale: 1:10	Part name: CV004	Top assembly: CV004	Client:
Unit:			Material:
	Description: Vinoteca para 4 botellas		Reference: CV004
			Count:
			Pages: 2 OF 4

Sign:

3 Baldas cromadas

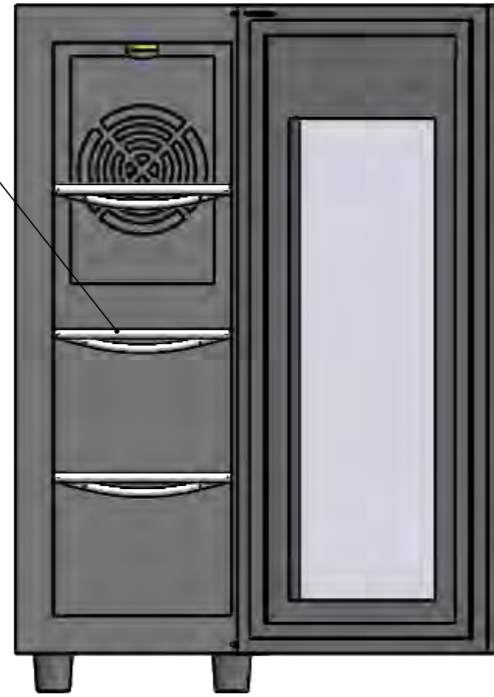

ventilación del equipo

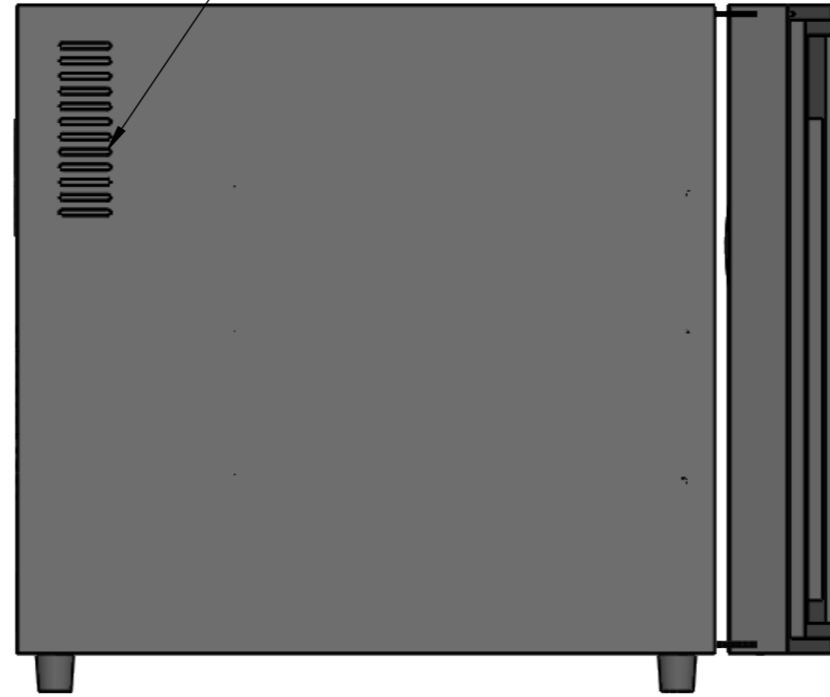

ventilación del equipo

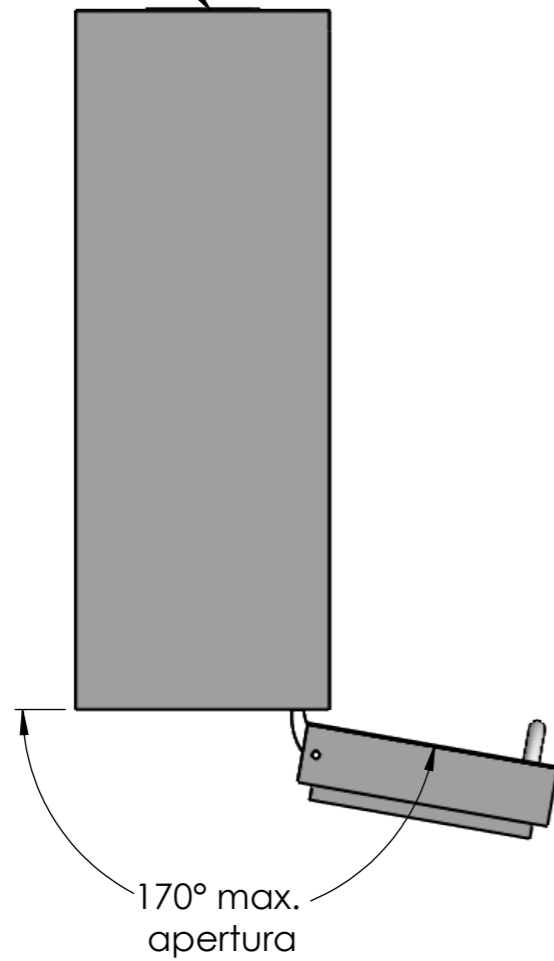

DATOS TÉCNICOS	
VOLUMEN	12L
Rango de temperatura	7-18°C
Botellas	4
Frecuencia	50-60Hz
Consumo	0.35(15°C)
Voltaje	220/240-110/115 V
Ruido	38db
Humedad interior	>70%RH
Sistema de frío	Termoeléctrico

Date	Name	cavanova®	
Design: 03/12/2018	Diego	<small>THE INFORMATION CONTAINED IN THIS DRAWING IS THE SOLE PROPERTY OF CAVANOVA WINE S.L. IN MÁLAGA, SPAIN. ANY REPRODUCTION IN PART OR AS A WHOLE WITHOUT THE WRITTEN PERMISSION OF CAVANOVA WINE S.L. IS PROHIBITED.</small>	
Checked:	Diego		
Modified:	Diego		
Scale: 1:10	Part name: CV004	Top assembly: CV004	Client:
Unit:	Description: Vinoteca para 4 botellas		Material:
			Reference: CV004
			Count:
			Pages: 3 OF 4

Sign:

MEDIDAS RECOMENDADAS	
Altura	463mm min
Anchura	50mm por cada lado
Profundidad	100mm separación

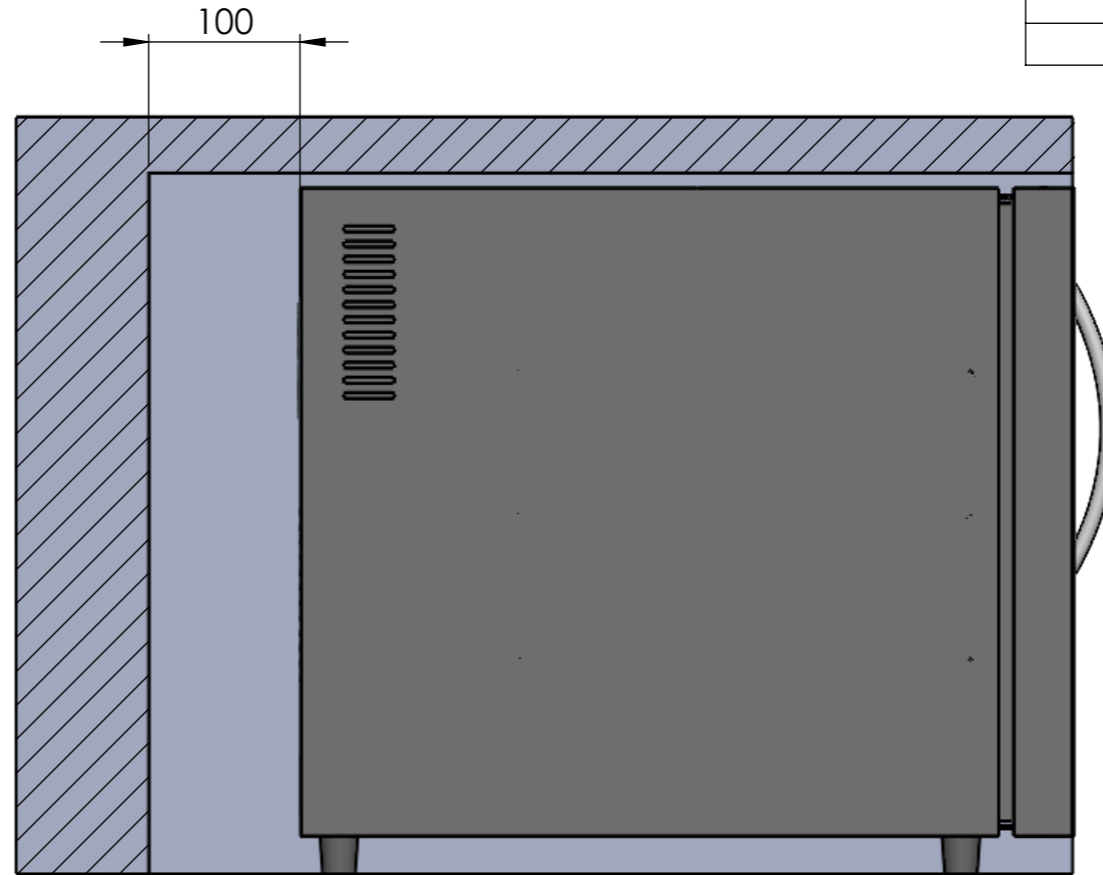
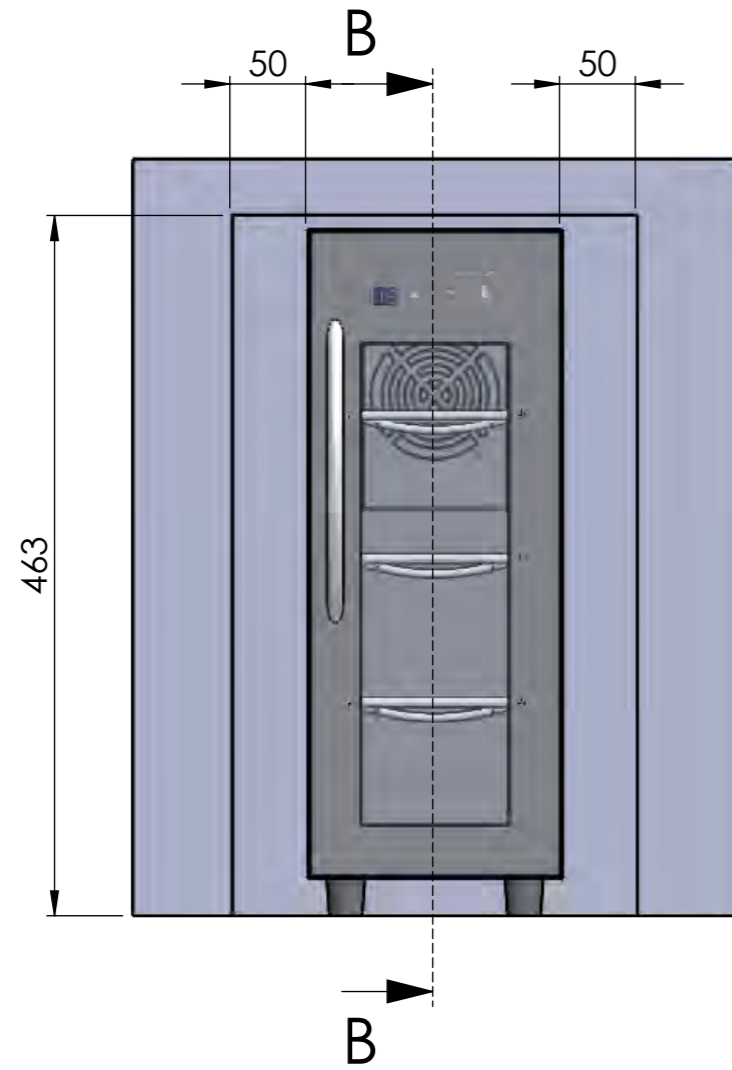

SECCIÓN B-B
ESCALA 1 : 5

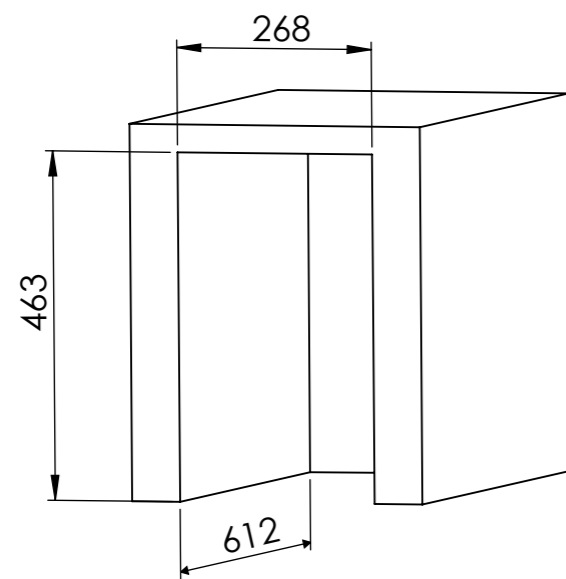
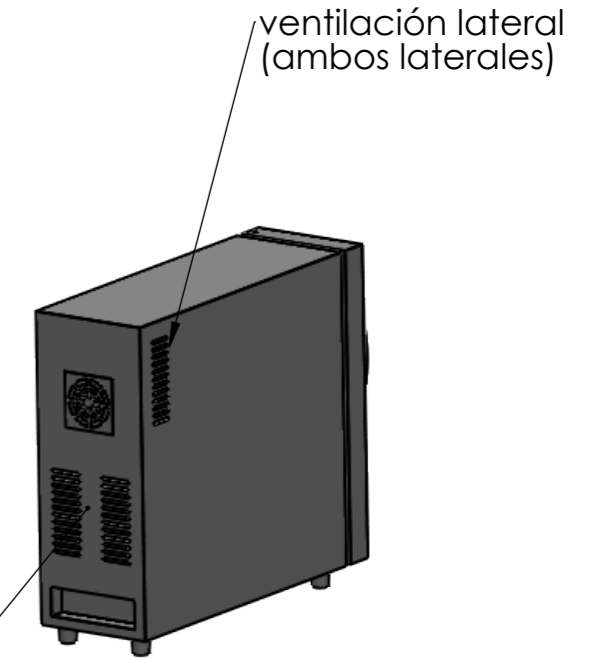

Medidas para hueco

Sign:

Date	Name	cavanova	
Design: 09/10/2018	Diego	<small>THE INFORMATION CONTAINED IN THIS DRAWING IS THE SOLE PROPERTY OF CAVANOVA WINE S.L. IN MÁLAGA, SPAIN. ANY REPRODUCTION IN PART OR AS A WHOLE WITHOUT THE WRITTEN PERMISSION OF CAVANOVA WINE S.L. IS PROHIBITED.</small>	
Checked:	Diego		
Modified:	Diego		
Scale: 1:10 Unit: mm	Part name: CV004-ENTORNO	Top assembly: CV004	Client: Cavanova
	Description: Empotramiento del equipo (built-in)		Material: Varios
			Reference: CV004-ENTORNO
			Count: Pages: 4 OF 4

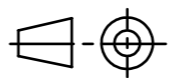

CV008NS

	Date	Name	 <small>THE INFORMATION CONTAINED IN THIS DRAWING IS THE SOLE PROPERTY OF CAVANOVA. ANY REPRODUCTION IN PART OR AS A WHOLE WITHOUT THE WRITTEN PERMISSION OF CAVANOVA IS PROHIBITED.</small>	
Design:	03/12/2018	Diego		
Checked:		Diego		
Modified:		Diego		
Notes:	Scale: 1:10	Part name: CV008NS	Top assembly: CV008NS	Client:
		Description: Vinoteca para 8 botellas		Material:
				Reference: CV008NS
				Count:
				Pages: 1 OF 4

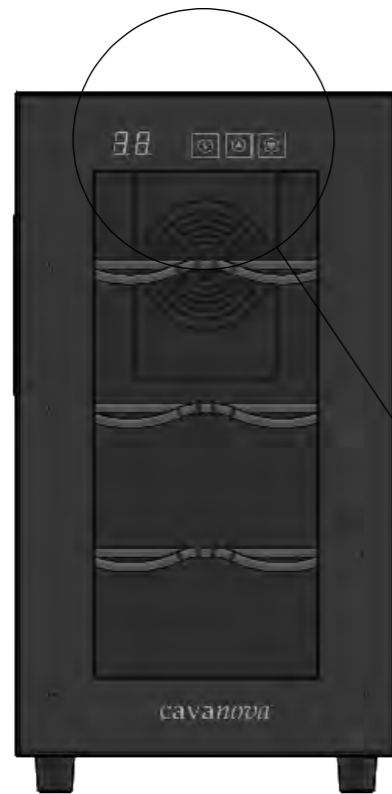

ALZADO

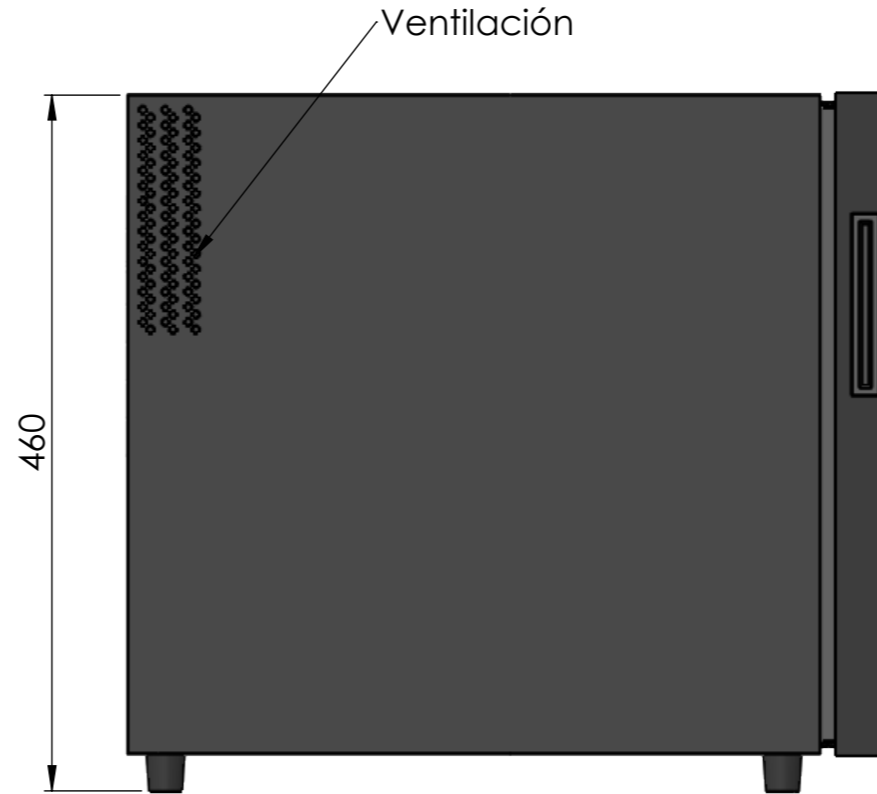

PERFIL

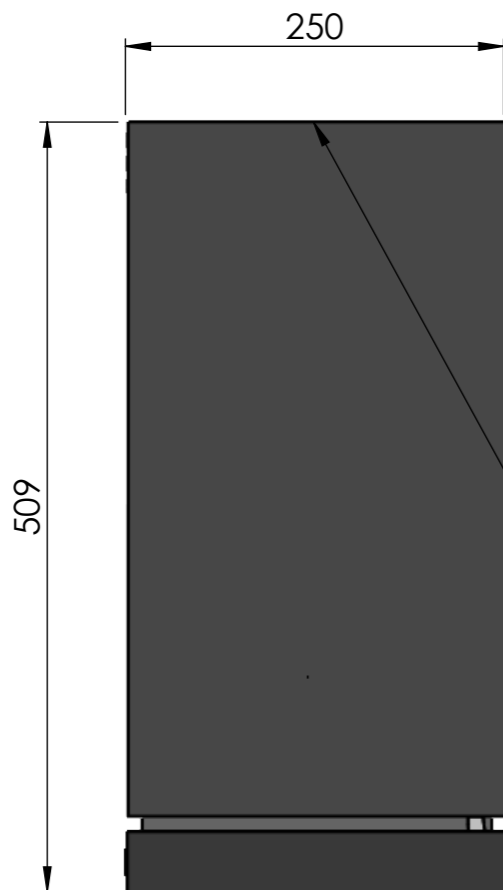

PLANTA

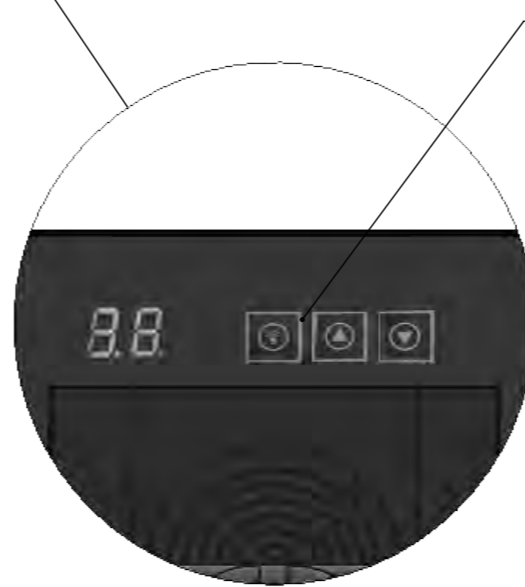

control táctil temperatura y luz



DATOS TÉCNICOS	
Volumen	23L
Botellas	8
Frecuencia	50-60hz
Consumo	0.5(15°C)
Voltaje	220/240-110/115V
Ruido	38db
Humedad interior	>70% RH
Sistema de frío	Termoeléctrico
Rango de temperatura	8-18°C

	Date	Name
Design:	03/12/2018	Diego
Checked:		Diego
Modified:		Diego

cavanova

THE INFORMATION CONTAINED IN THIS DRAWING IS THE SOLE PROPERTY OF CAVANOVA WINE S.L. IN MÁLAGA, SPAIN. ANY REPRODUCTION IN PART OR AS A WHOLE WITHOUT THE WRITTEN PERMISSION OF CAVANOVA WINE S.L. IS PROHIBITED.

Sign:

Scale: 1:10	Part name: CV008NS	Top assembly: CV008NS	Client:
Unit:			Material:
	Description: Vinoteca para 8 botellas		Reference: CV008NS
			Count:
			Pages: 2 OF 4

Client:
Material:
Reference: CV008NS
Count:
Pages: 2 OF 4

4 baldas cromadas



ALZADO

250

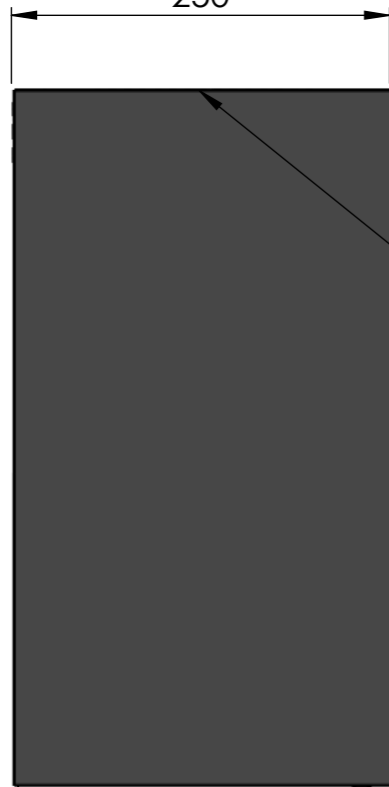

PLANTA

170° max. apertura

Ventilación

Ventilación

460

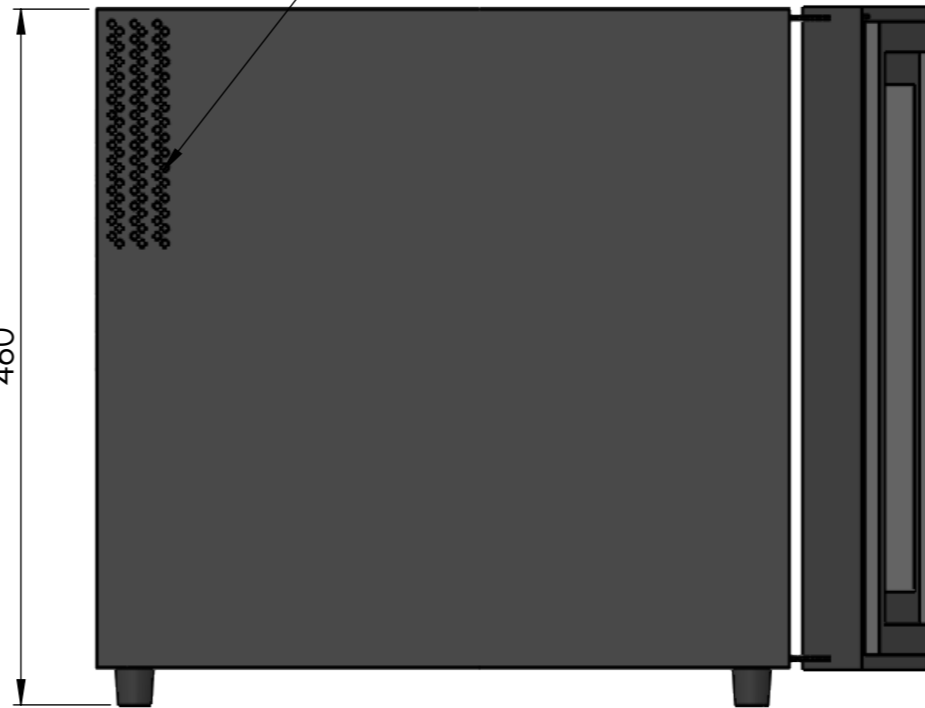

PERFIL

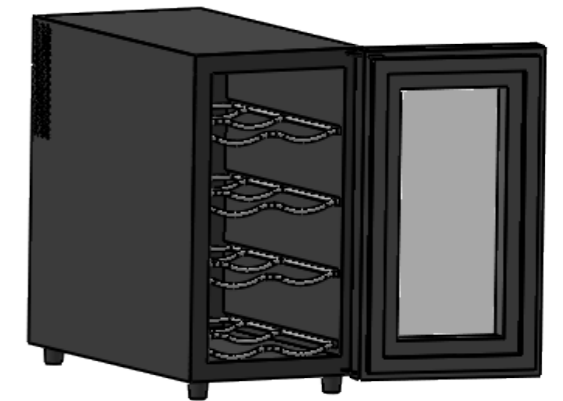

DATOS TÉCNICOS

Volumen	23L
Botellas	8
Frecuencia	50-60hz
Consumo	0.5(15°C)
Voltaje	220/240-110/115V
Ruido	38db
Humedad interior	>70% RH
Sistema de frío	Termoeléctrico
Rango de temperatura	8-18°C

	Date	Name
Design:	03/12/2018	Diego
Checked:		Diego
Modified:		Diego
Scale: 1:10	Part name: CV008NS	
Unit:	Top assembly: CV008NS	

cavano

THE INFORMATION CONTAINED IN THIS DRAWING IS THE SOLE PROPERTY OF CAVANOVA WINE S.L. IN MÁLAGA, SPAIN. ANY REPRODUCTION IN PART OR AS A WHOLE WITHOUT THE WRITTEN PERMISSION OF CAVANOVA WINE S.L. IS PROHIBITED.

Sign:

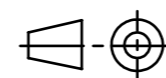

Description:
Apertura de puerta

Client:
Material:
Reference: CV008NS
Count:
Pages: 3 OF 4

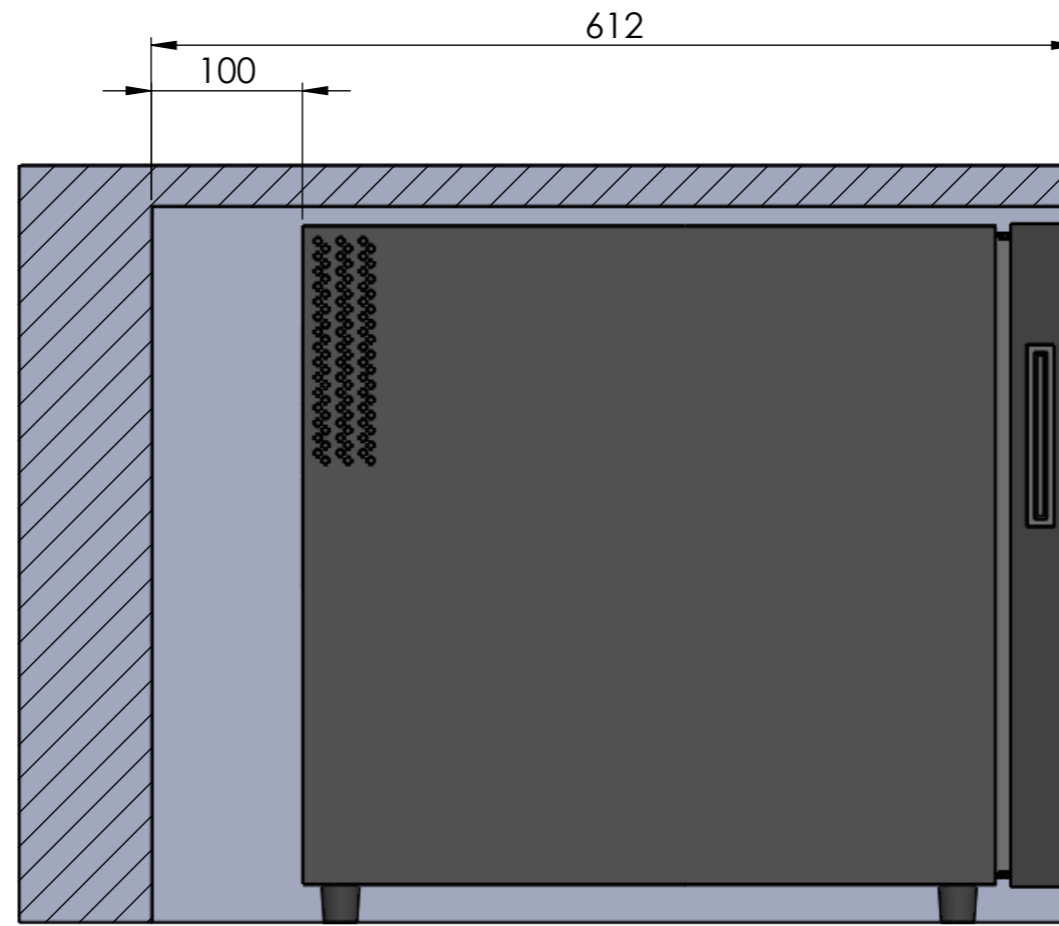
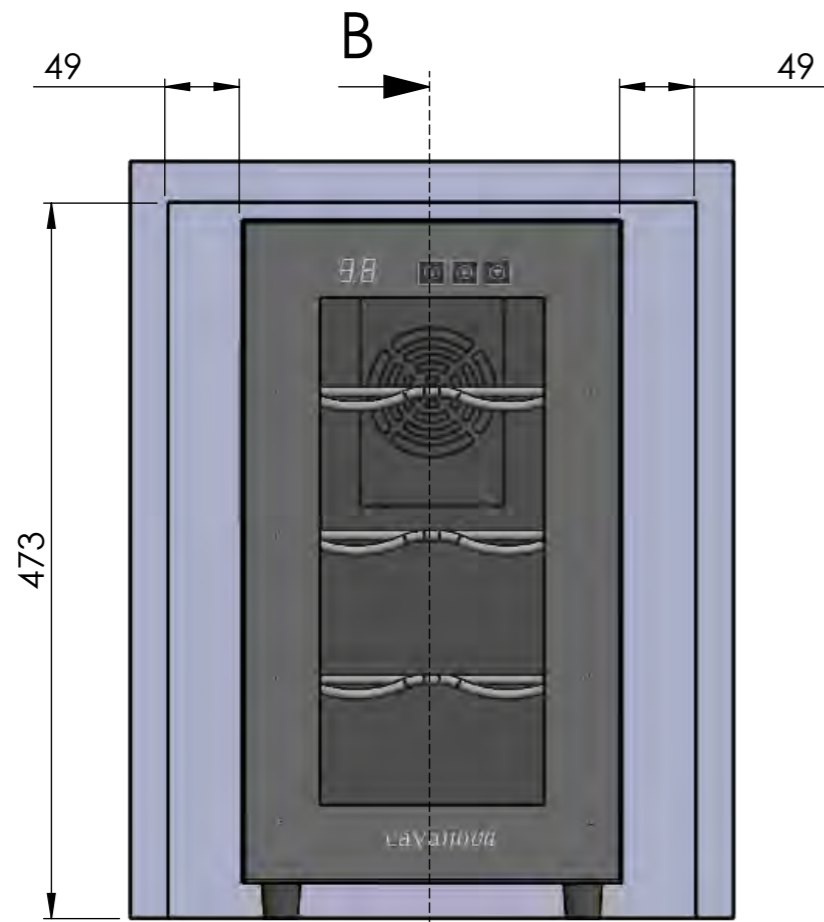

SECCIÓN B-B
ESCALA 1 : 5

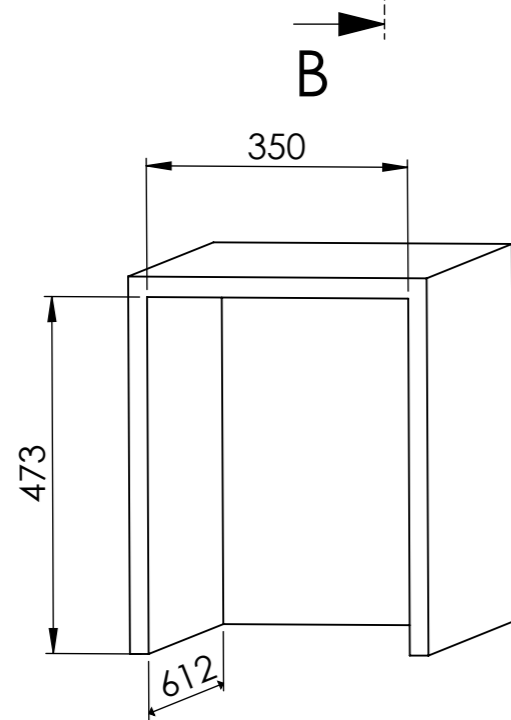

Medidas para hueco

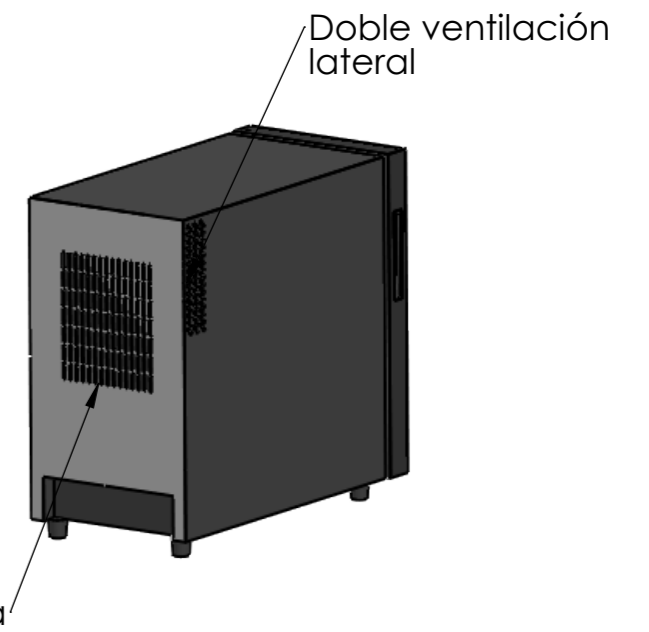

NO OBSTRUIR VENTILACIÓN

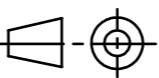
	Date	Name	 <small>THE INFORMATION CONTAINED IN THIS DRAWING IS THE SOLE PROPERTY OF CAVANOVA WINE S.L. IN MÁLAGA, SPAIN. ANY REPRODUCTION IN PART OR AS A WHOLE WITHOUT THE WRITTEN PERMISSION OF CAVANOVA WINE S.L. IS PROHIBITED.</small>	
Design:	09/10/2018	Diego		
Checked:		Diego		
Modified:		Diego		
Sign:	Scale: 1:10	Part name: CV008NS-ENTORNO	Top assembly: CV008ns	Client: Cavanova
	Unit: mm			Material: Varios
	Description: Empotramiento del equipo (built-in)			Reference: CV008NS-ENTORNO
				Count:
				Pages: 4 OF 4

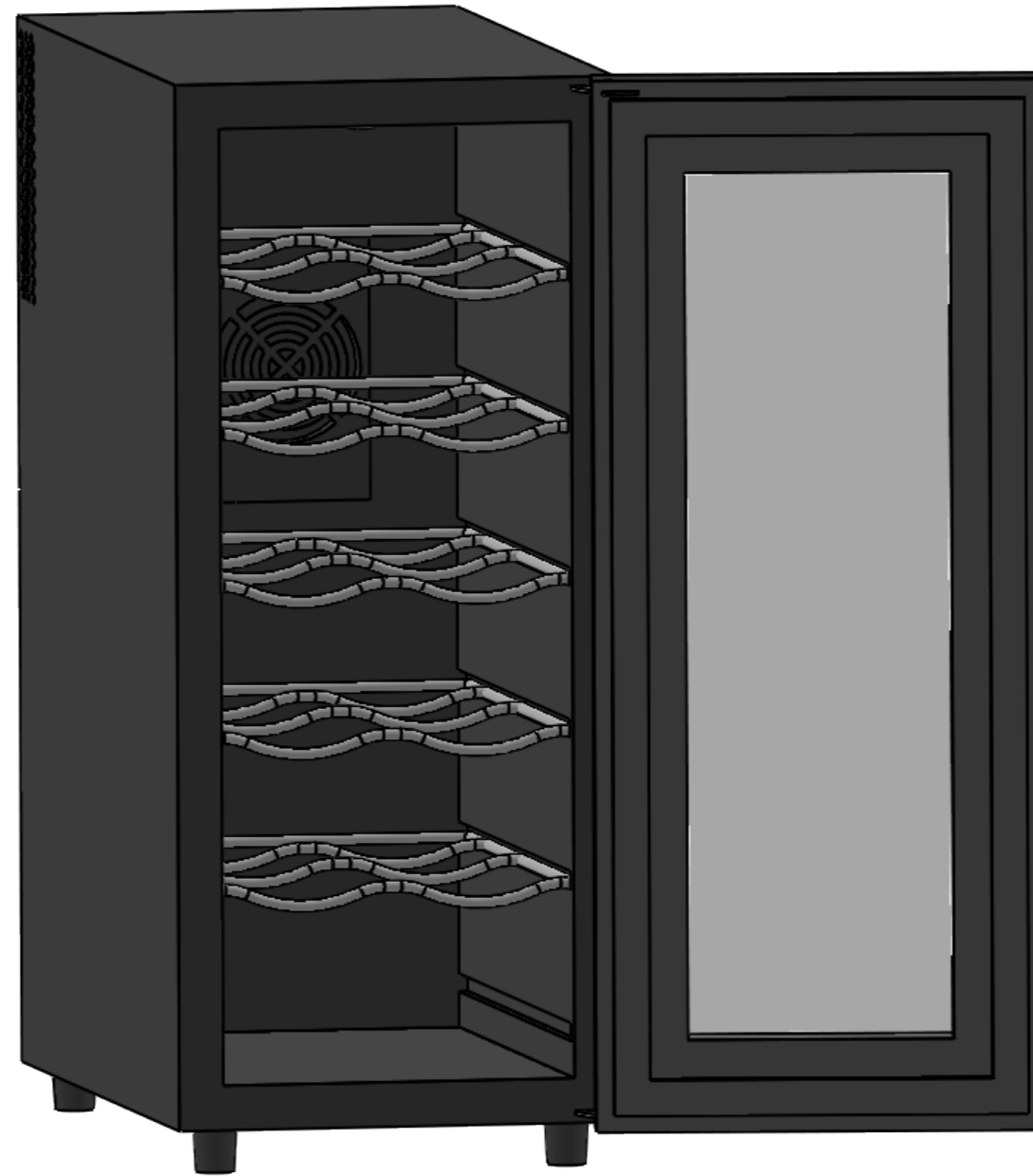
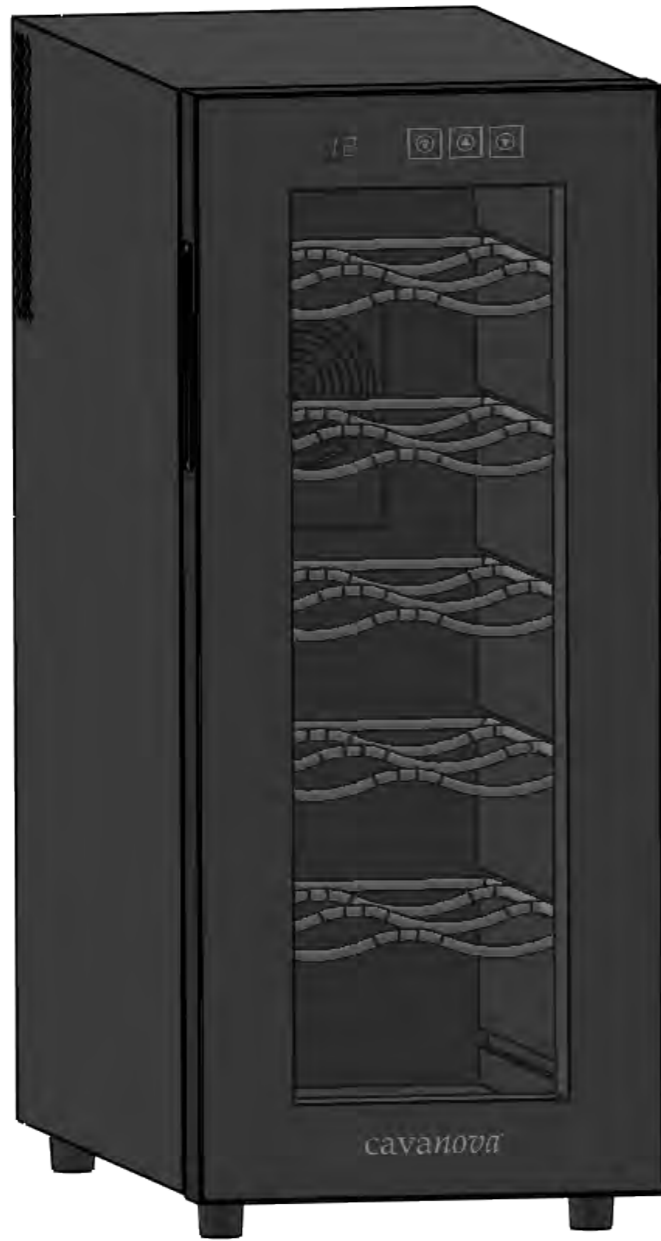

CV012M

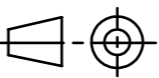
Notes:		Date	Name	 <small>THE INFORMATION CONTAINED IN THIS DRAWING IS THE SOLE PROPERTY OF CAVANOVA. ANY REPRODUCTION IN PART OR AS A WHOLE WITHOUT THE WRITTEN PERMISSION OF CAVANOVA IS PROHIBITED.</small>
	Design:	03/12/2018	Diego	
	Checked:		Diego	
	Modified:		Diego	
	Scale: 1:10	Part name: CV012M	Top assembly: CV012M	Client:
		Description:	Material:	
		Vinoteca para 12botellas	Reference: CV012M	
			Count:	
			Pages: 1 OF 4	



ALZADO

Ventilación

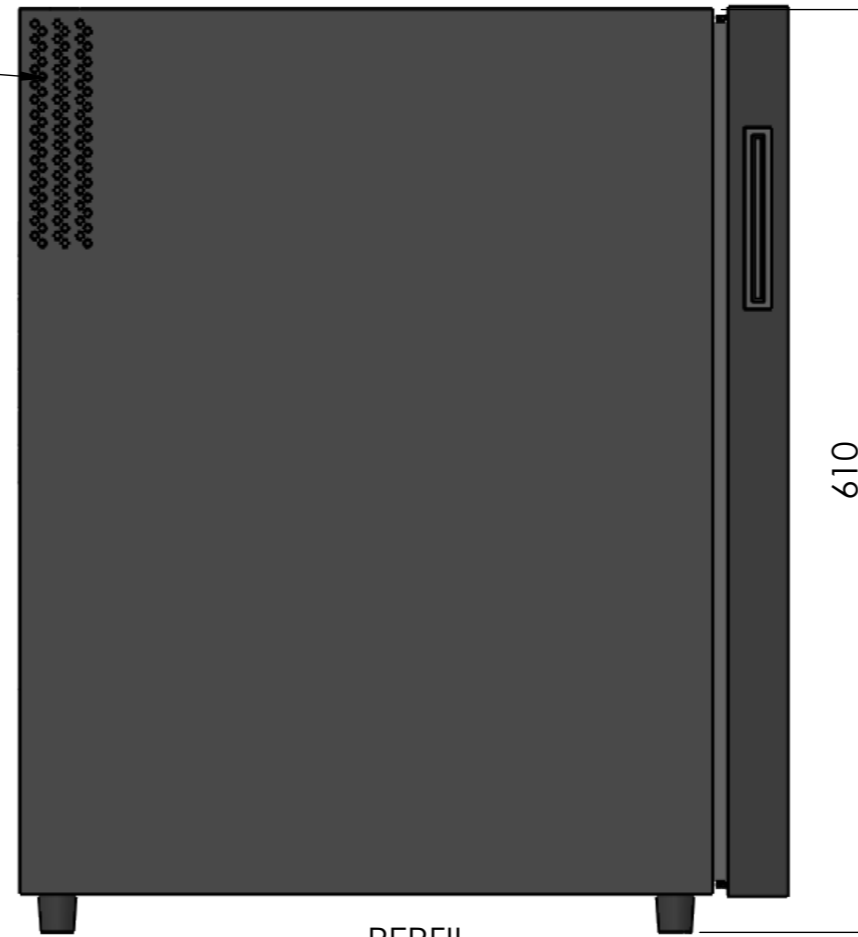

PERFIL

610

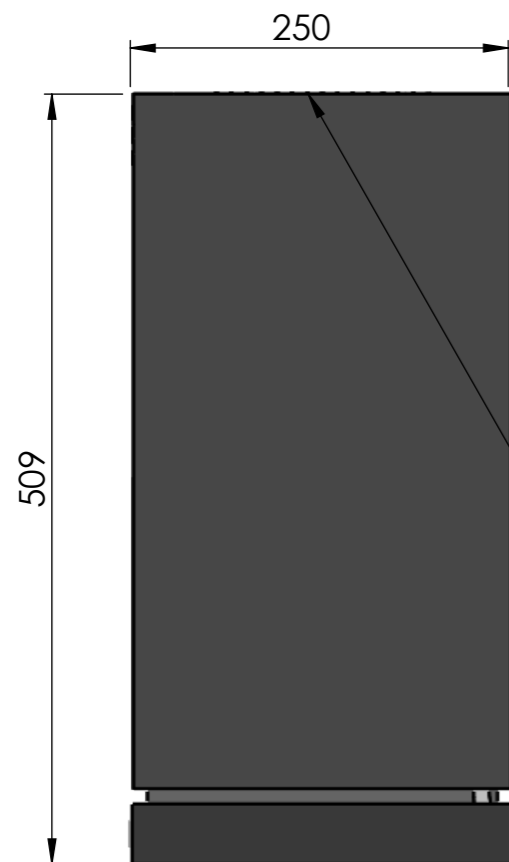

PLANTA

Ventilación



control táctil
temperatura y luz

DATOS TÉCNICOS

Volumen	33L
Botellas	12
Frecuencia	50-60hz
Consumo	0.35(15°C)
Voltaje	220/240-110/115V
Ruido	38db
Humedad interior	>70% RH
Sistema de frío	Termoeléctrico
Rango de temperatura	12-18°C

	Date	Name
Design:	03/12/2018	Diego
Checked:		Diego
Modified:		Diego
Scale: 1:10	Part name: CV012M	
Unit:	Top assembly: CV012M	

cavanoa

THE INFORMATION CONTAINED IN THIS DRAWING IS THE SOLE PROPERTY OF CAVANOVA WINE S.L. IN MÁLAGA, SPAIN. ANY REPRODUCTION IN PART OR AS A WHOLE WITHOUT THE WRITTEN PERMISSION OF CAVANOVA WINE S.L. IS PROHIBITED.

Sign:

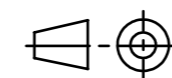

Description:
Vinoteca para 12botellas

Client:
Material:
Reference: CV012M
Count:
Pages: 2 OF 4

6 baldas cromadas

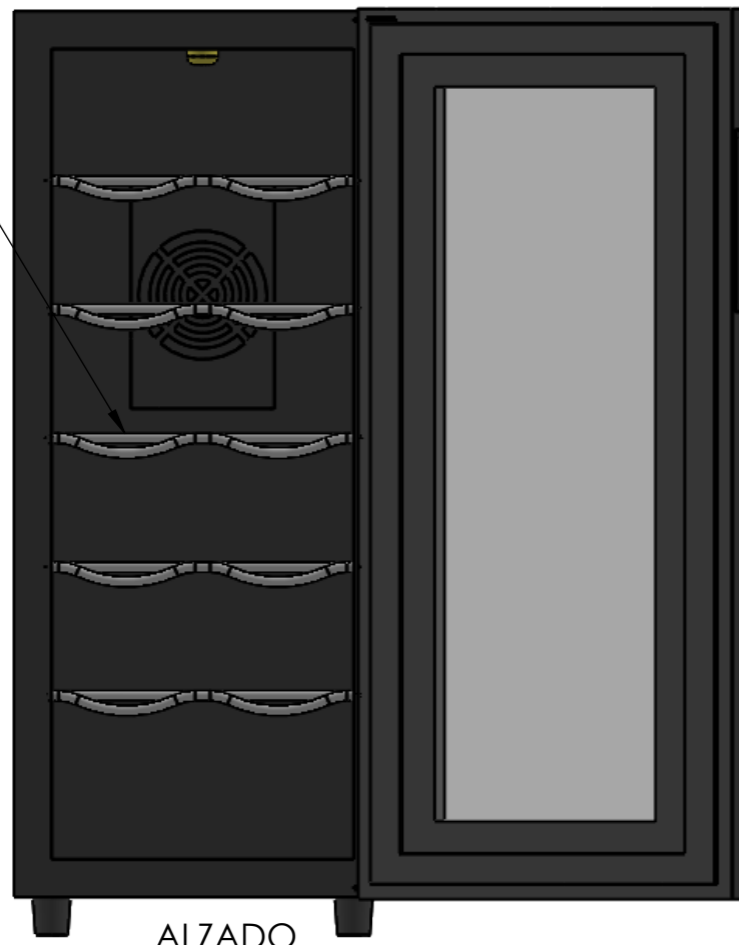

ALZADO

Ventilación

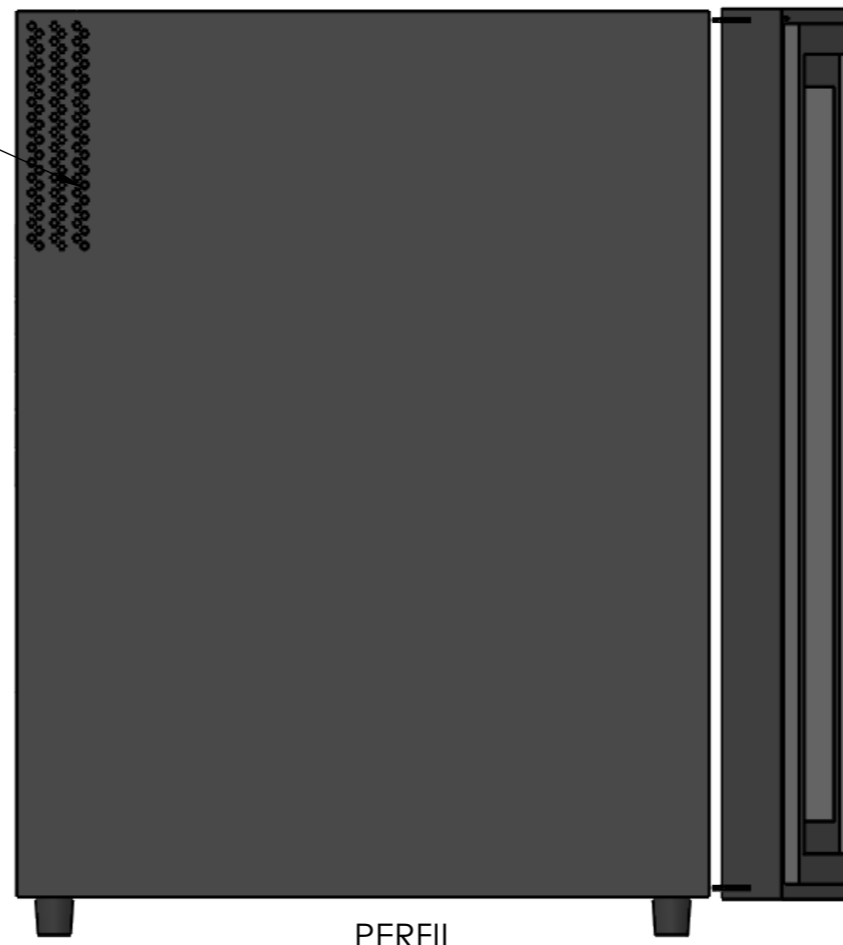

PERFIL

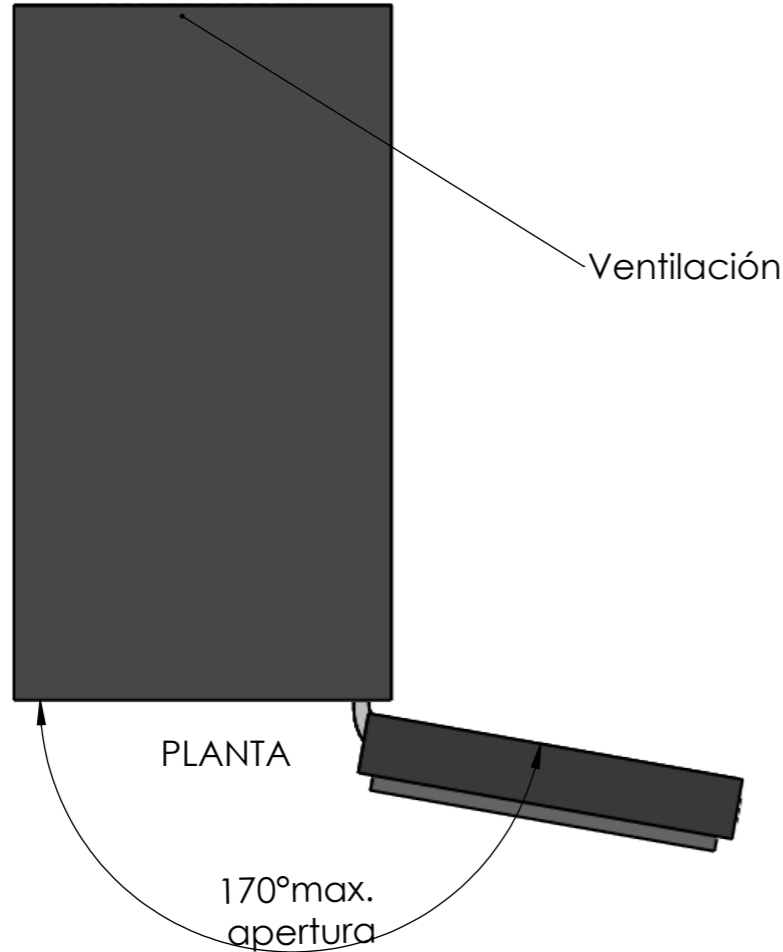
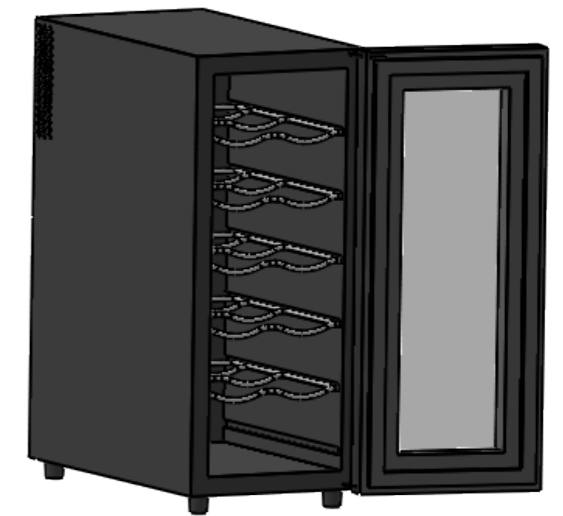

PLANTA

Ventilación

170°max. apertura

DATOS TÉCNICOS

Volumen	33L
Botellas	12
Frecuencia	50-60hz
Consumo	0.35(15°C)
Voltaje	220/240-110/115V
Ruido	38db
Humedad interior	>70% RH
Sistema de frío	Termoeléctrico
Rango de temperatura	12-18°C

	Date	Name
Design:	03/12/2018	Diego
Checked:		Diego
Modified:		Diego
Scale: 1:10	Part name: CV012M	
Unit:	Top assembly: CV012M	

cavanoa

THE INFORMATION CONTAINED IN THIS DRAWING IS THE SOLE PROPERTY OF CAVANOVA WINE S.L. IN MÁLAGA, SPAIN. ANY REPRODUCTION IN PART OR AS A WHOLE WITHOUT THE WRITTEN PERMISSION OF CAVANOVA WINE S.L. IS PROHIBITED.

Sign:

Description:
Apertura de puerta

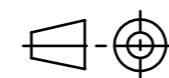

Client:
Material:
Reference: CV012M
Count:
Pages: 3 OF 4

MEDIDAS RECOMENDADAS	
ALTURA	623mm mín
PROFUNDIDAD	100mm mín
ANCHURA	50mm por cada lado

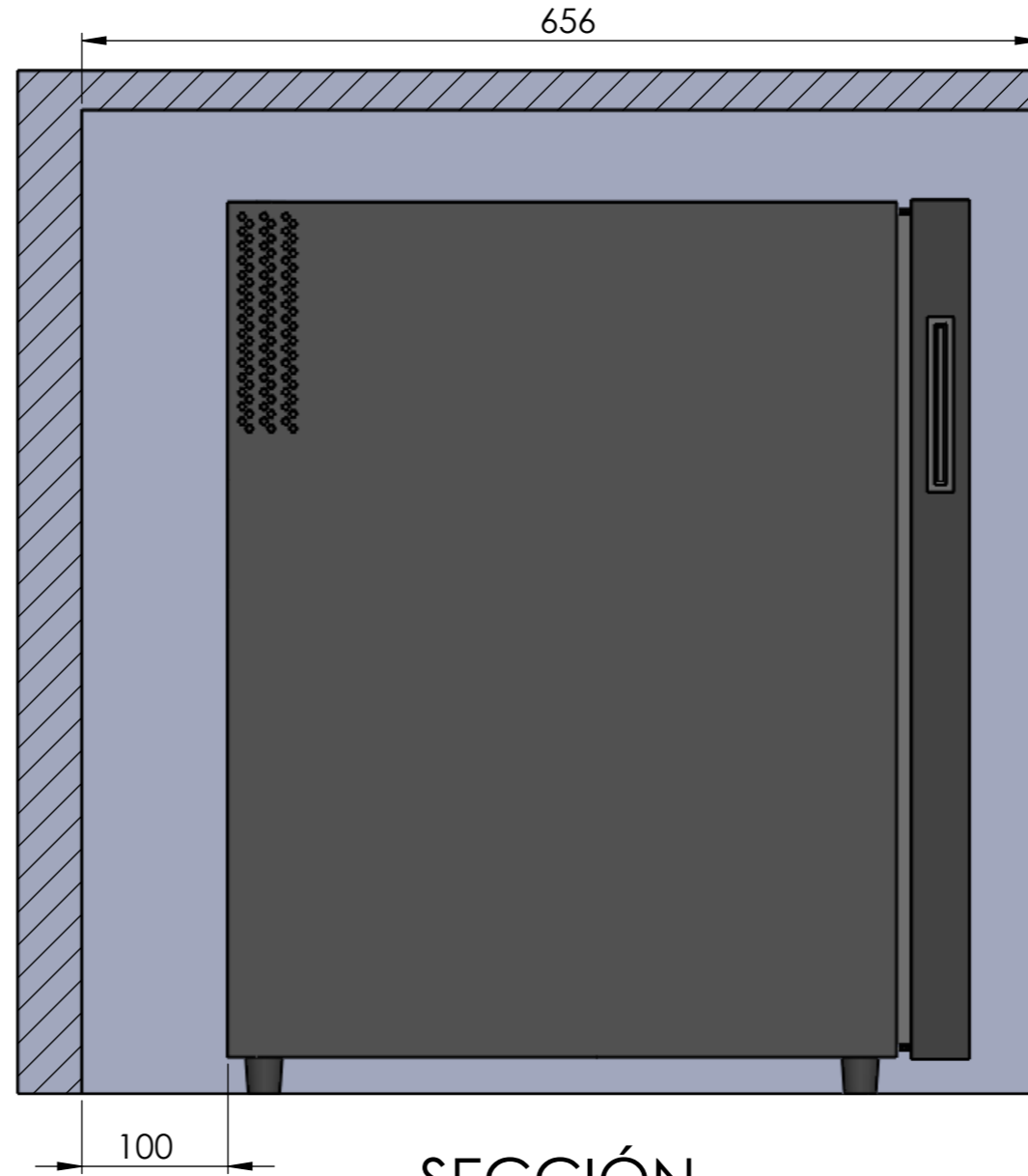
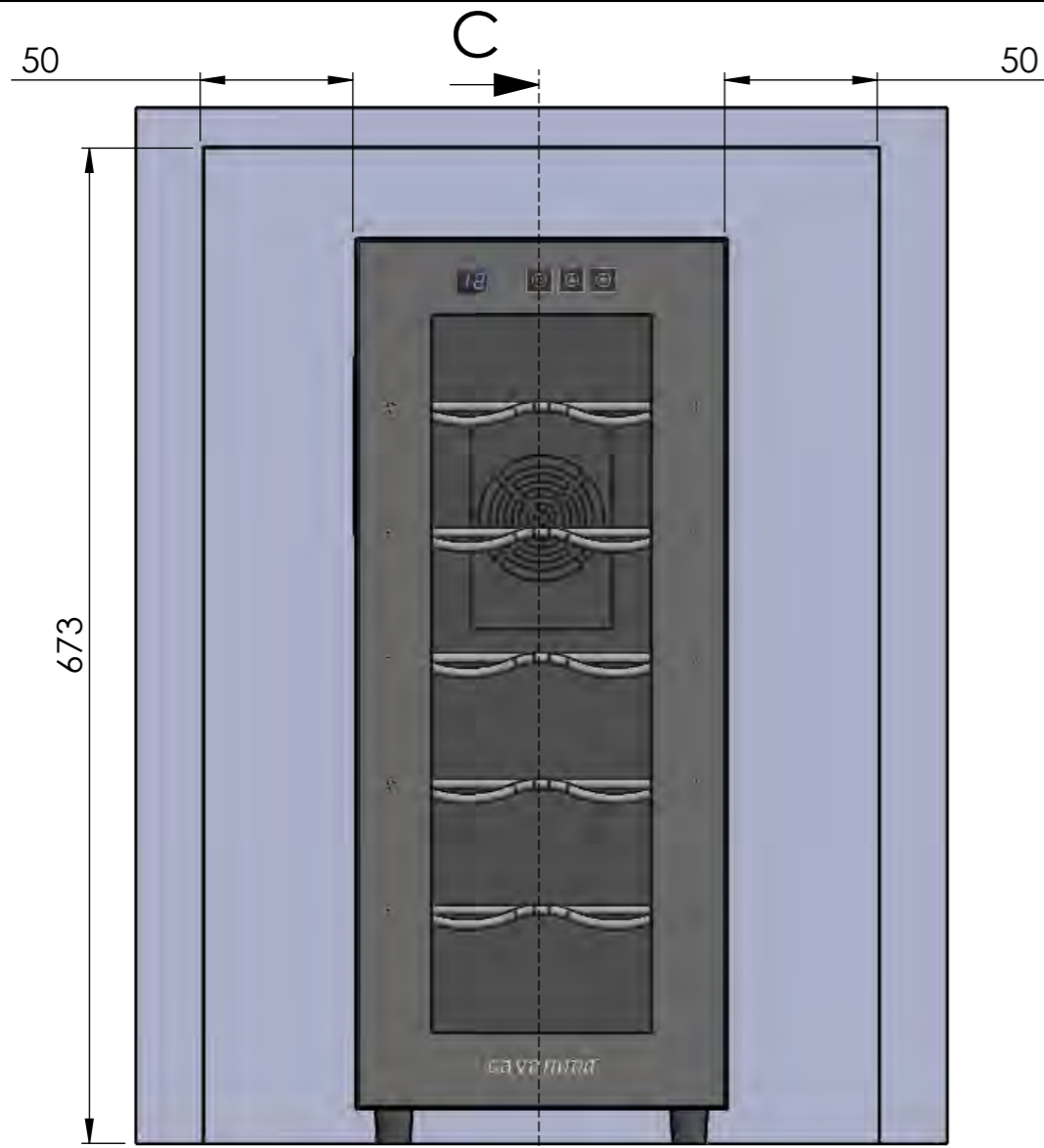

SECCIÓN C-C
ESCALA 1:5

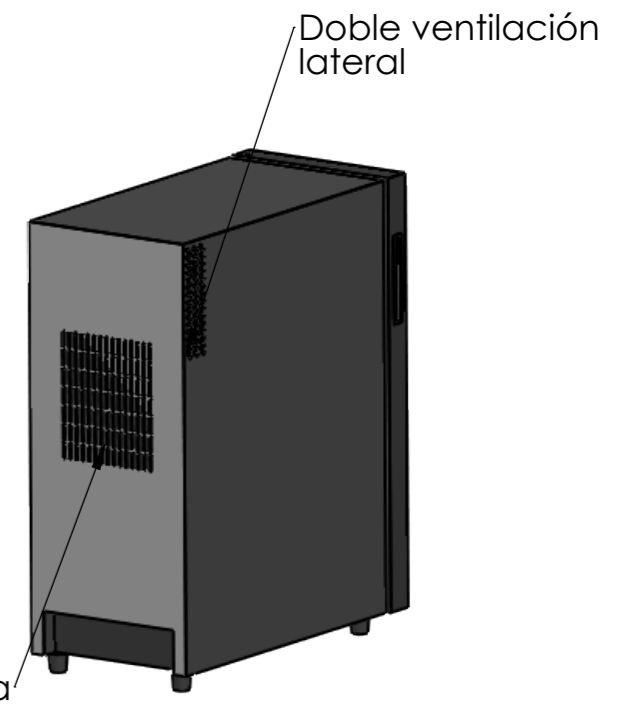

NO OBSTRUIR VENTILACIÓN

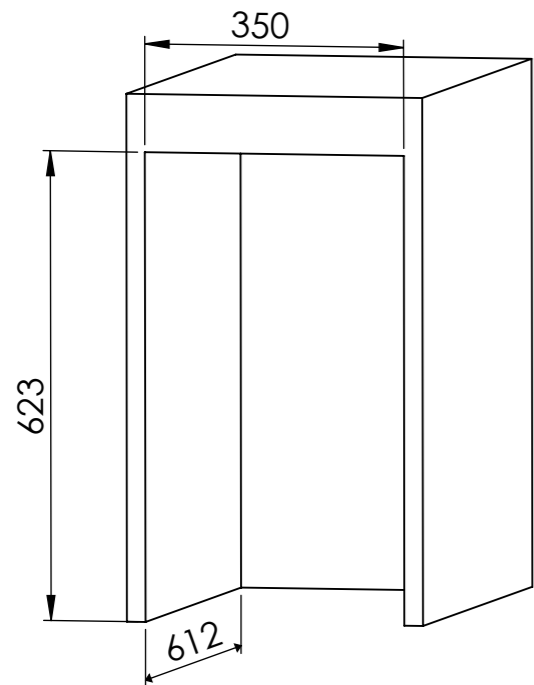

Medidas para hueco

Sign: _____

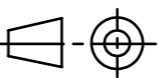
Date	Name	 <small>THE INFORMATION CONTAINED IN THIS DRAWING IS THE SOLE PROPERTY OF CAVANOVA WINE S.L. IN MÁLAGA, SPAIN. ANY REPRODUCTION IN PART OR AS A WHOLE WITHOUT THE WRITTEN PERMISSION OF CAVANOVA WINE S.L. IS PROHIBITED.</small>		
Design: 09/10/2018	Diego			
Checked:	Diego	Part name: CV012M-ENTORNO	Top assembly: CV008ns	Client: Cavanova
Modified:	Diego			Material: Varios
Scale: 1:10		Description: Empotramiento del equipo (built-in)	Reference: CV012M-ENTORNO	
Unit: mm			Count:	
			Pages: 4 OF 4	

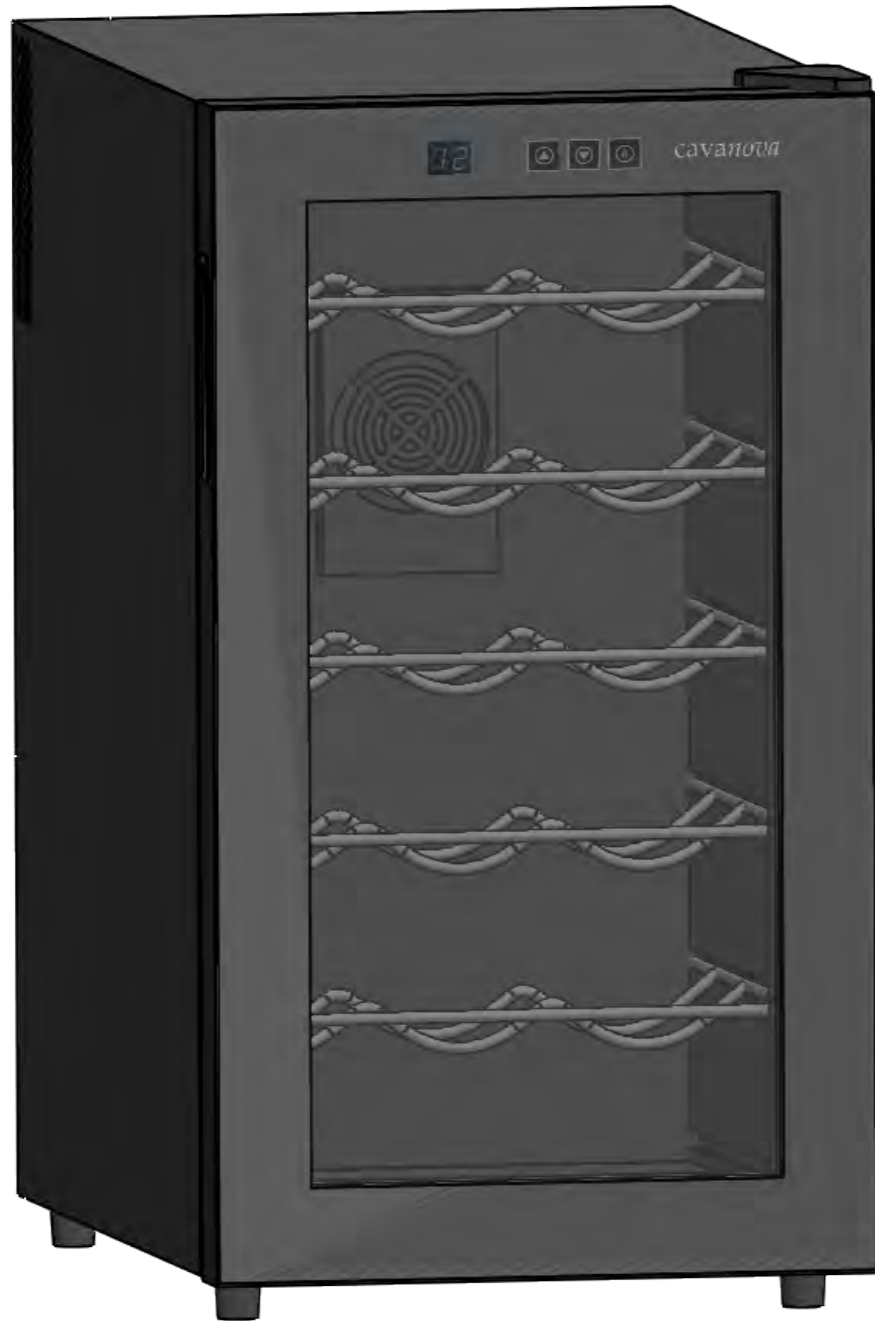

CV018M

Notes:

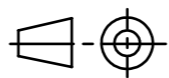
	Date	Name	 <small>THE INFORMATION CONTAINED IN THIS DRAWING IS THE SOLE PROPERTY OF CAVANOVA. ANY REPRODUCTION IN PART OR AS A WHOLE WITHOUT THE WRITTEN PERMISSION OF CAVANOVA IS PROHIBITED.</small>	
Design:	03/12/2018	Diego		
Checked:		Diego		
Modified:		Diego		
Scale:	1:10	Part name: CV018M	Top assembly: CV018M	Client:
	Description:			Material:
	Vinoteca para 18botellas			Reference: CV018M
				Count:
				Pages: 1 OF 4

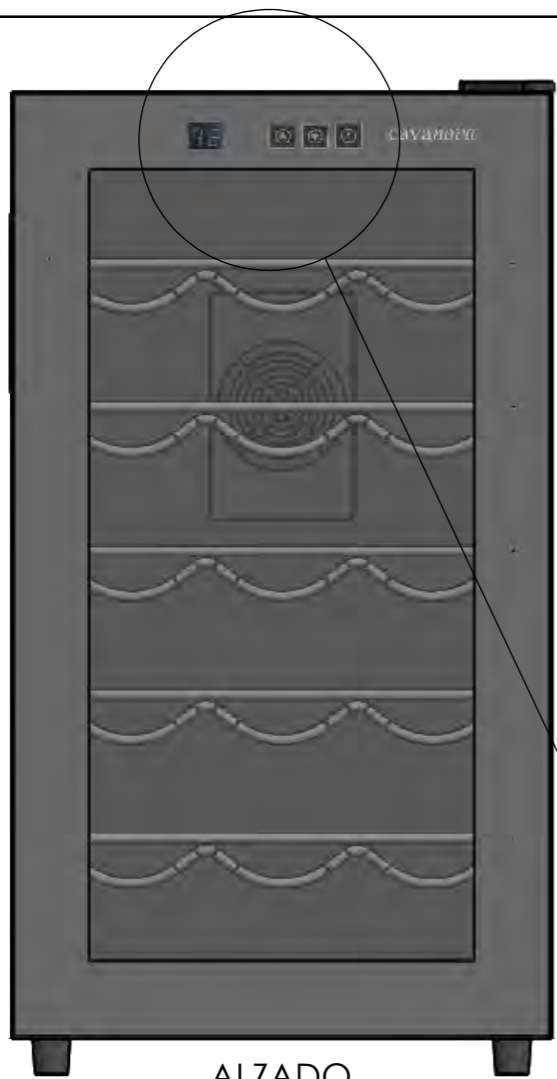

ALZADO
355

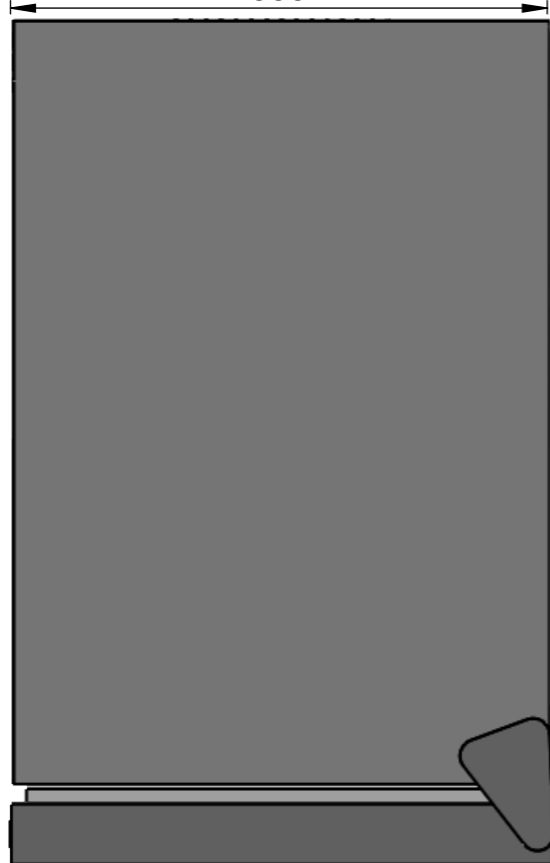

PLANTA

Ventilación

Ventilación

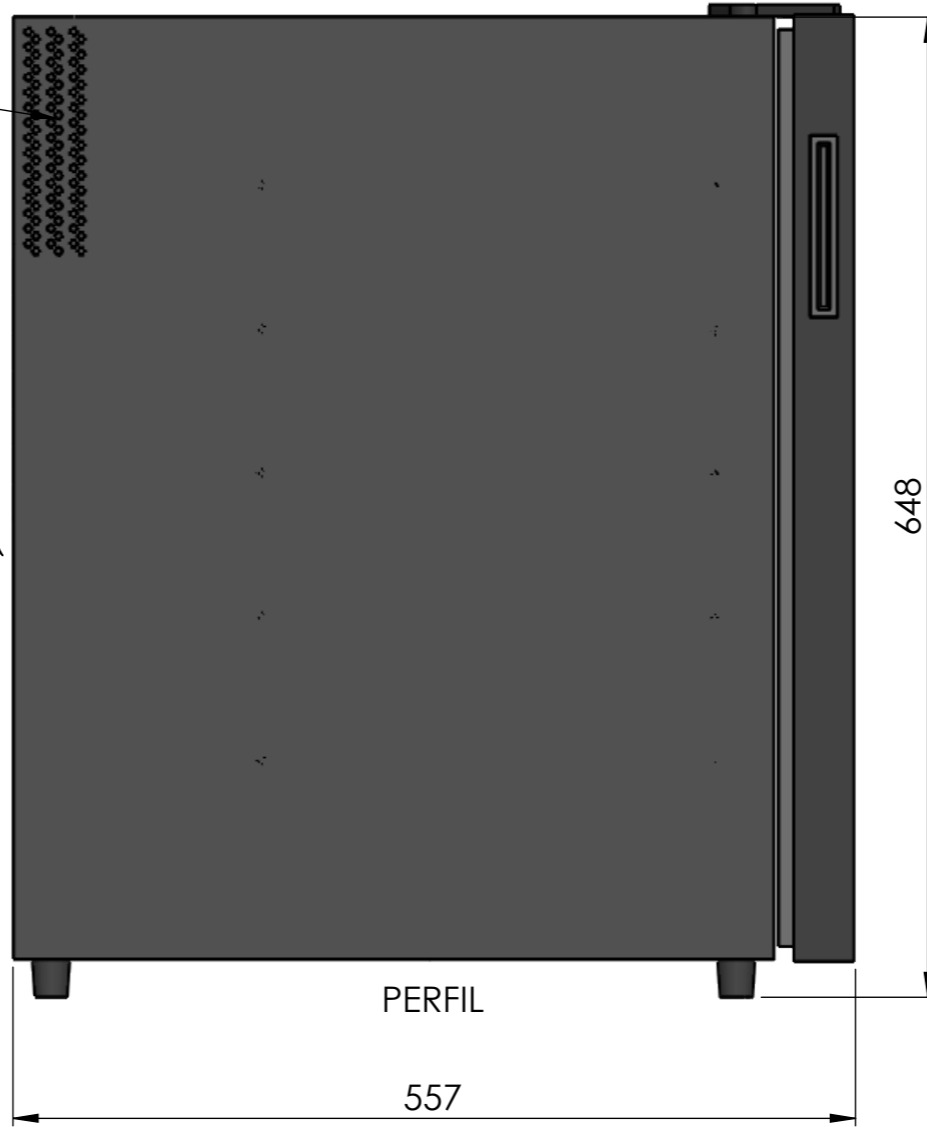

PERFIL

557

648



control táctil
temperatura
y luz

DATOS TÉCNICOS

Volumen	48L
Botellas	18
Frecuencia	50-60hz
Consumo	0.47(15°C)kw/d
Voltaje	220/240-110/115V
Ruido	38db
Humedad interior	>70% RH
Sistema de frío	Termoeléctrico
Rango de temperatura	12-18°C

	Date	Name
Design:	03/12/2018	Diego
Checked:		Diego
Modified:		Diego
Scale: 1:10	Part name: CV018M	
Unit:	Top assembly: CV018M	

cavanova

THE INFORMATION CONTAINED IN THIS DRAWING IS THE SOLE PROPERTY OF CAVANOVA WINE S.L. IN MÁLAGA, SPAIN. ANY REPRODUCTION IN PART OR AS A WHOLE WITHOUT THE WRITTEN PERMISSION OF CAVANOVA WINE S.L. IS PROHIBITED.

Sign:

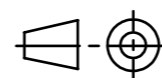

Description:
Vinoteca para 18botellas

Client:
Material:
Reference: CV018M
Count:
Pages: 2 OF 4



ALZADO

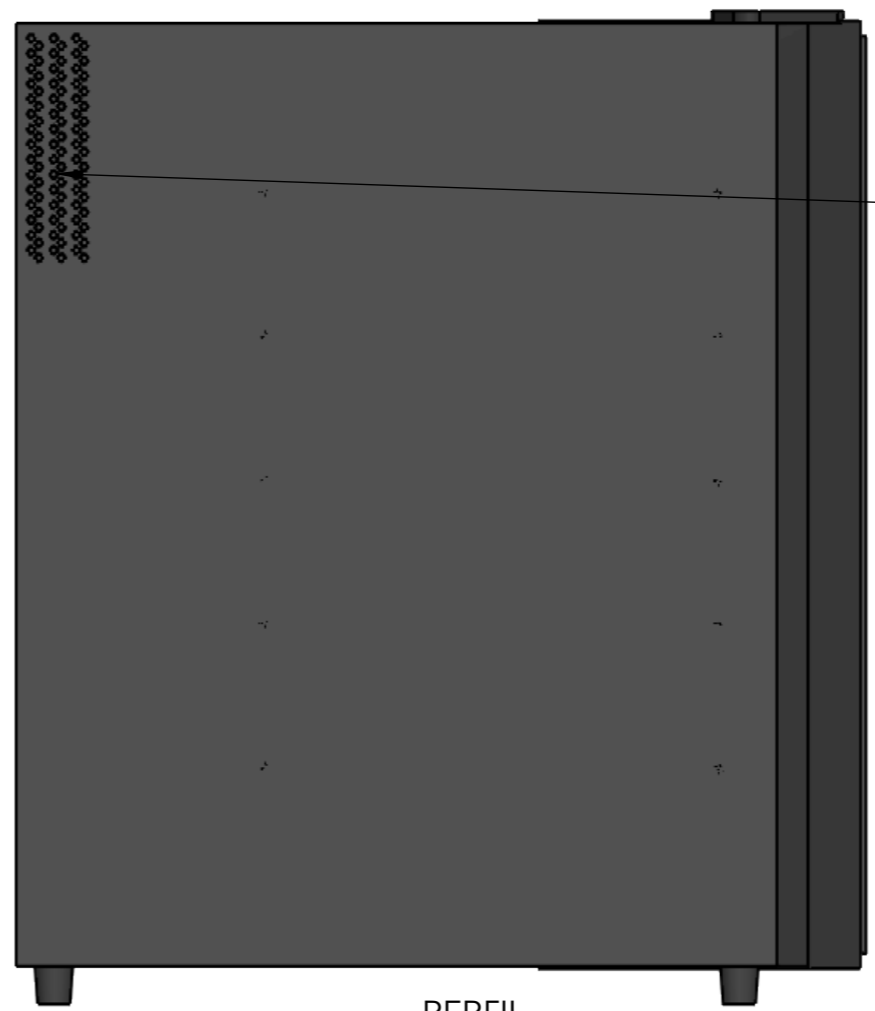

PERFIL

Ventilación

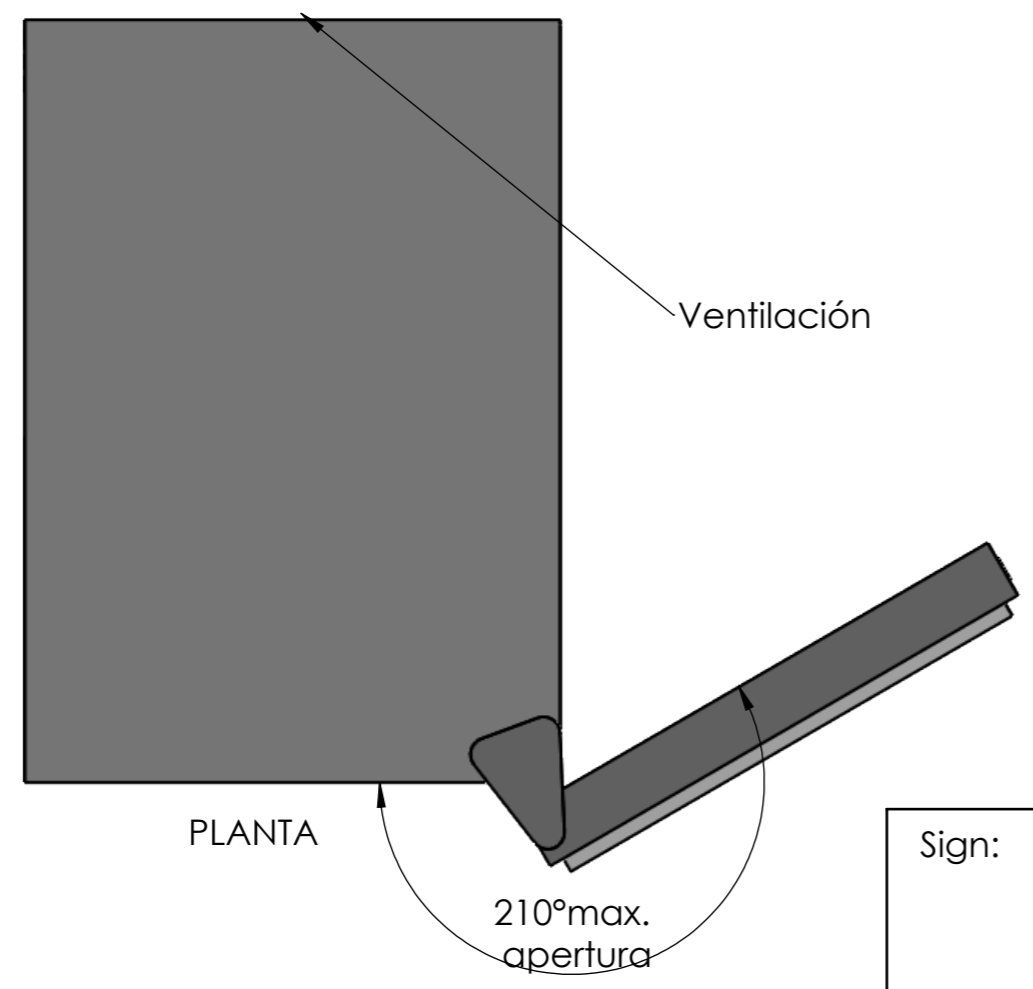

PLANTA

DATOS TÉCNICOS	
Volumen	48L
Botellas	18
Frecuencia	50-60hz
Consumo	0.47(15°C)kw/d
Voltaje	220/240-110/115V
Ruido	38db
Humedad interior	>70% RH
Sistema de frío	Termoeléctrico
Rango de temperatura	12-18°C

	Date	Name
Design:	03/12/2018	Diego
Checked:		Diego
Modified:		Diego
Scale: 1:10	Part name: CV018M	
Unit:	Top assembly: CV018M	

cavanoa
THE INFORMATION CONTAINED IN THIS DRAWING IS THE SOLE PROPERTY OF CAVANOVA WINE S.L. IN MÁLAGA, SPAIN. ANY REPRODUCTION IN PART OR AS A WHOLE WITHOUT THE WRITTEN PERMISSION OF CAVANOVA WINE S.L. IS PROHIBITED.

Sign:

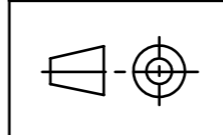

Description:
Apertura de puerta

Client:
Material:
Reference: CV018M
Count:
Pages: 3 OF 4

MEDIDAS RECOMENDADAS	
ALTURA	673mm mín
PROFUNDIDAD	100mm mín (libre atrás)
ANCHURA	50mm por cada lado

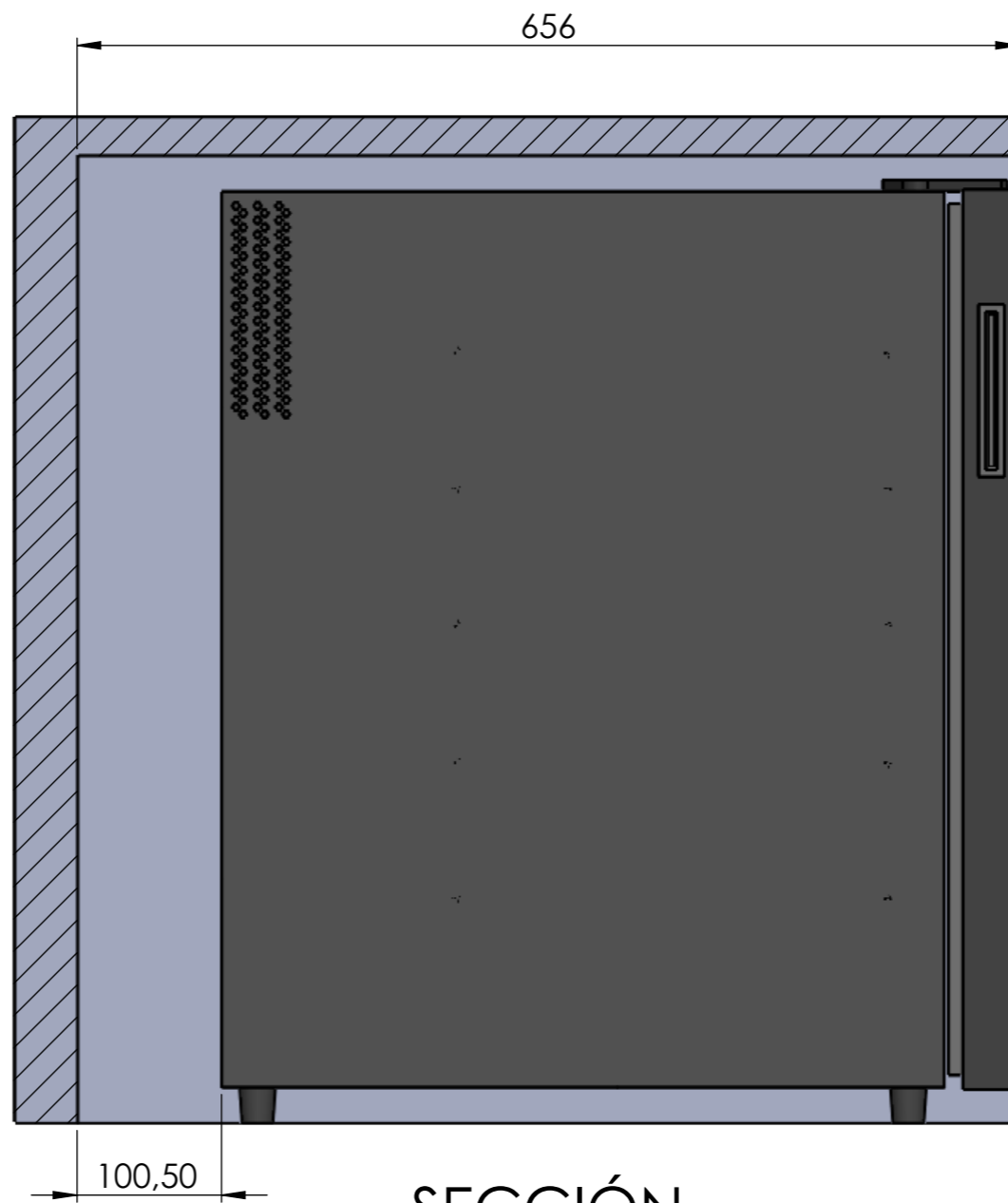
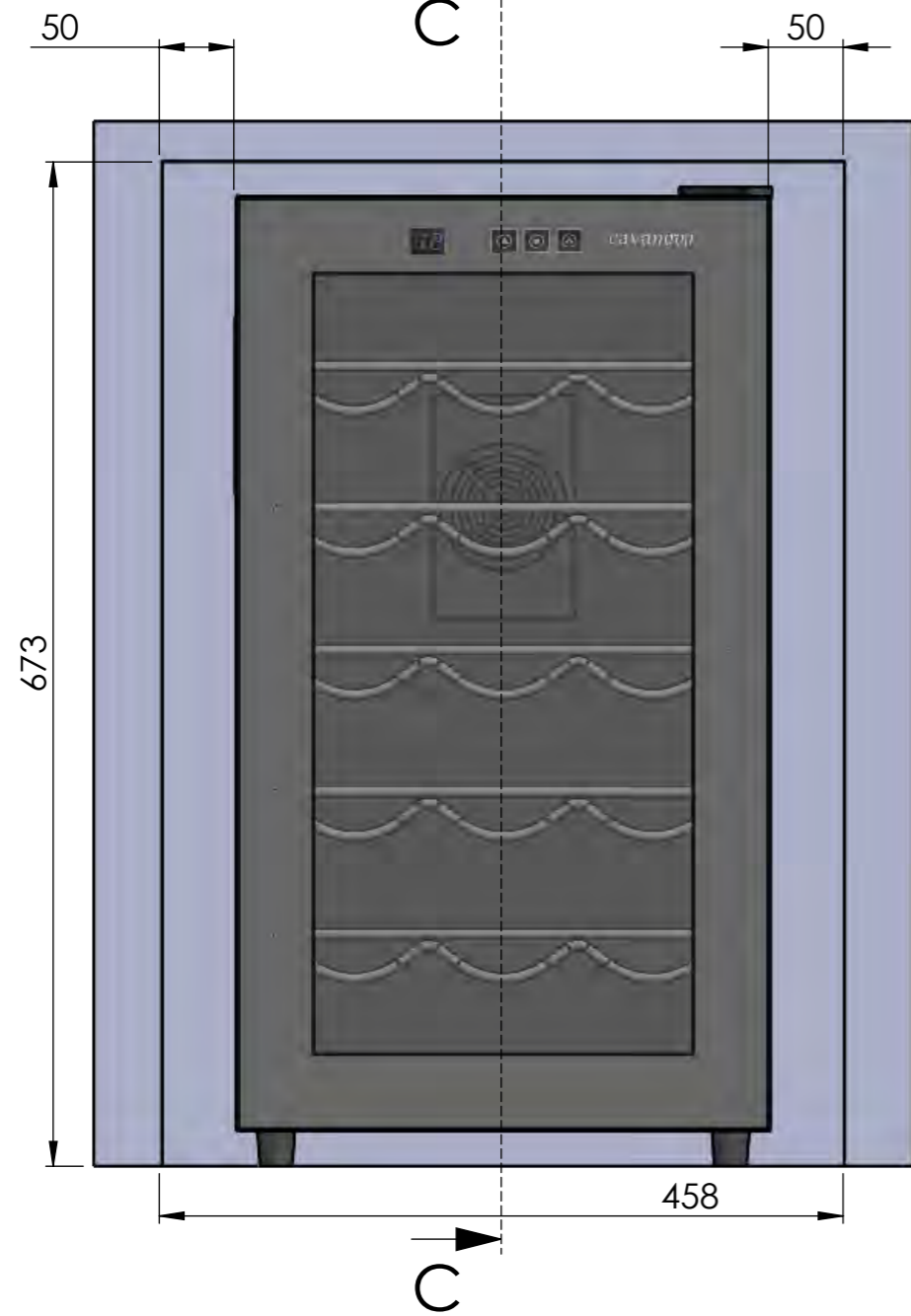

SECCIÓN C-C
ESCALA 1:5

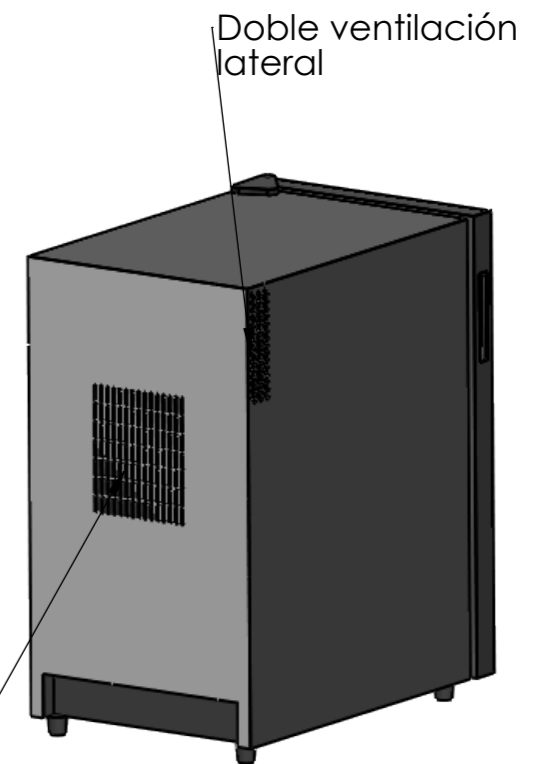

NO OBSTRUIR VENTILACIÓN

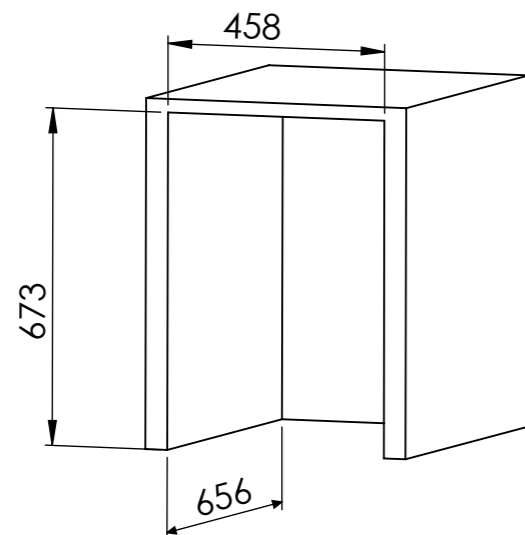

Medidas para hueco

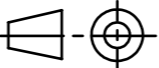
Date	Name	 <small>THE INFORMATION CONTAINED IN THIS DRAWING IS THE SOLE PROPERTY OF CAVANOVA WINE S.L. IN MÁLAGA, SPAIN. ANY REPRODUCTION IN PART OR AS A WHOLE WITHOUT THE WRITTEN PERMISSION OF CAVANOVA WINE S.L. IS PROHIBITED.</small>		
Design:	09/10/2018			Diego
Checked:				Diego
Modified:				Diego
Scale: 1:10	Part name:	Top assembly:	Client: Cavanova	
Unit: mm	CV018M-ENTORNO	CV018M		Material: Varios
Sign:	Description:		Reference: CV018M-ENTORNO	
	Empotramiento del equipo (built-in)		Count:	
			Pages: 4 OF 4	

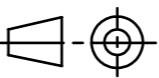

CV028NS

	Date	Name	 <small>THE INFORMATION CONTAINED IN THIS DRAWING IS THE SOLE PROPERTY OF CAVANOVA. ANY REPRODUCTION IN PART OR AS A WHOLE WITHOUT THE WRITTEN PERMISSION OF CAVANOVA IS PROHIBITED.</small>
Design:	03/12/2018	Diego	
Checked:		Diego	
Modified:		Diego	
Notes:	Scale: 1:10	Part name: CV028NS	Top assembly: CV028NS
		Description:	Client:
		Vinoteca para 28botellas	Material:
			Reference: CV028NS
			Count:
			Pages: 1 OF 4

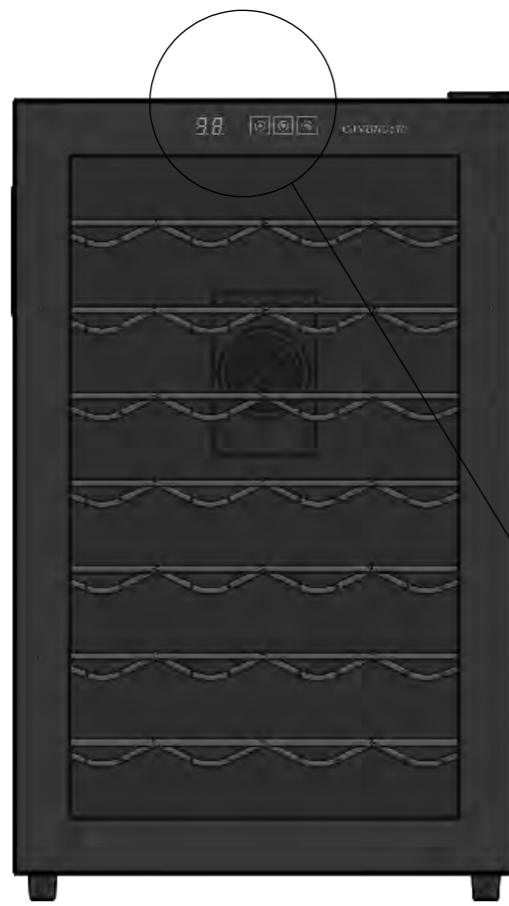

ALZADO

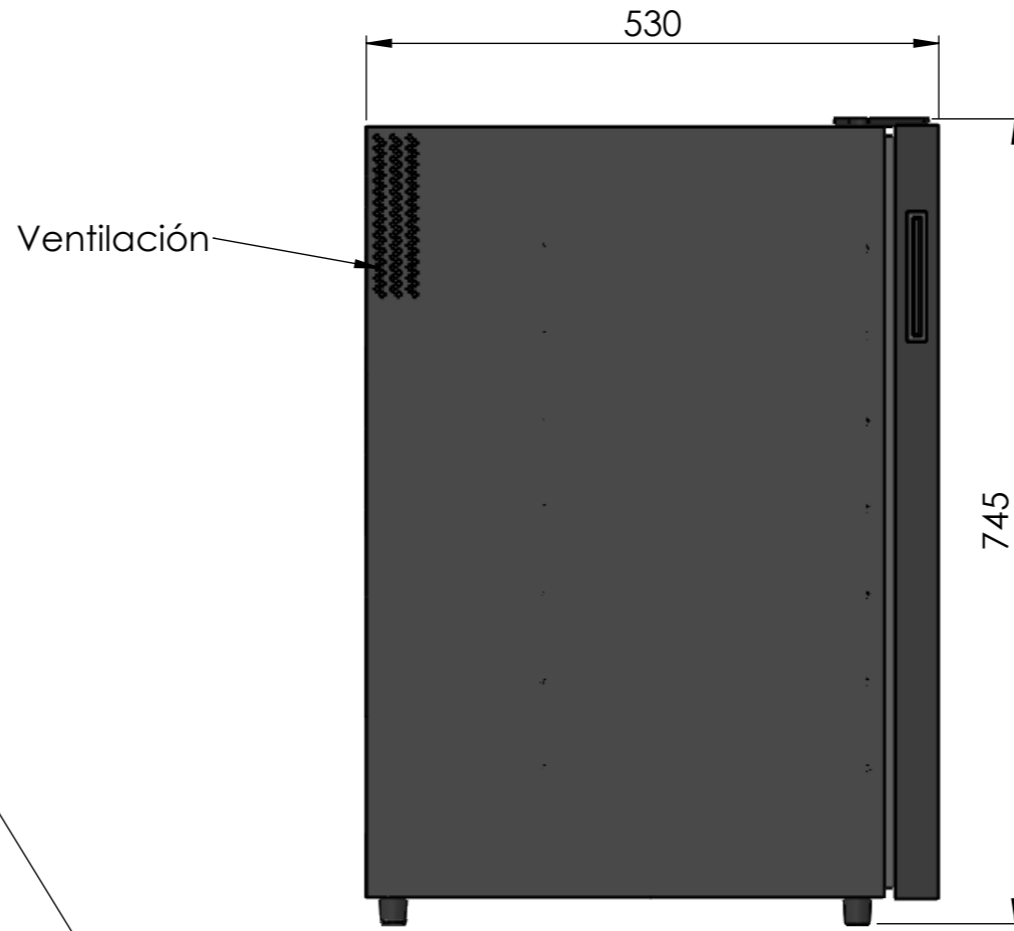

PERFIL

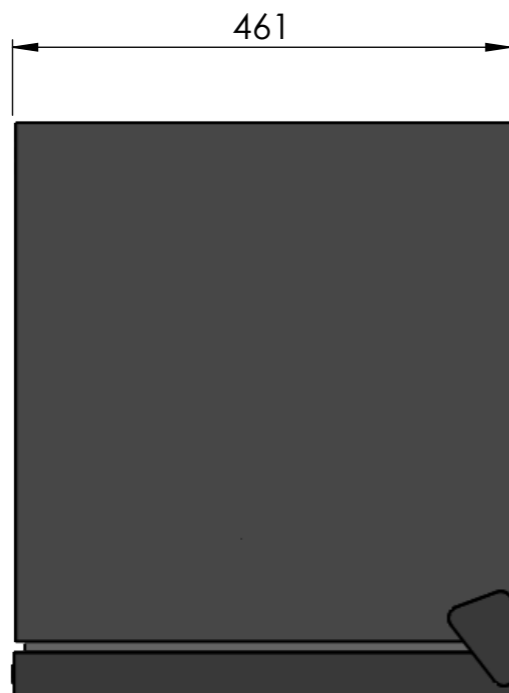

PLANTA



control táctil
temperatura
y luz

DATOS TÉCNICOS	
Volumen	65L
Botellas	28
Frecuencia	50-60hz
Consumo	1(15°C)kw/d
Voltaje	220/240-110/115V
Ruido	38db
Humedad interior	>70% RH
Sistema de frío	Termoeléctrico
Rango de temperatura	12-18°C

	Date	Name
Design:	03/12/2018	Diego
Checked:		Diego
Modified:		Diego

cavanoa

THE INFORMATION CONTAINED IN THIS DRAWING IS THE SOLE PROPERTY OF CAVANOVA WINE S.L. IN MÁLAGA, SPAIN. ANY REPRODUCTION IN PART OR AS A WHOLE WITHOUT THE WRITTEN PERMISSION OF CAVANOVA WINE S.L. IS PROHIBITED.

Sign:

Scale: 1:10
Unit:

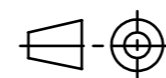

Part name:
CV028NS

Description:
Vinoteca para 28botellas

Top assembly:
CV028NS

Client:
Material:
Reference: CV028NS
Count:
Pages: 2 OF 4

6 baldas cromadas

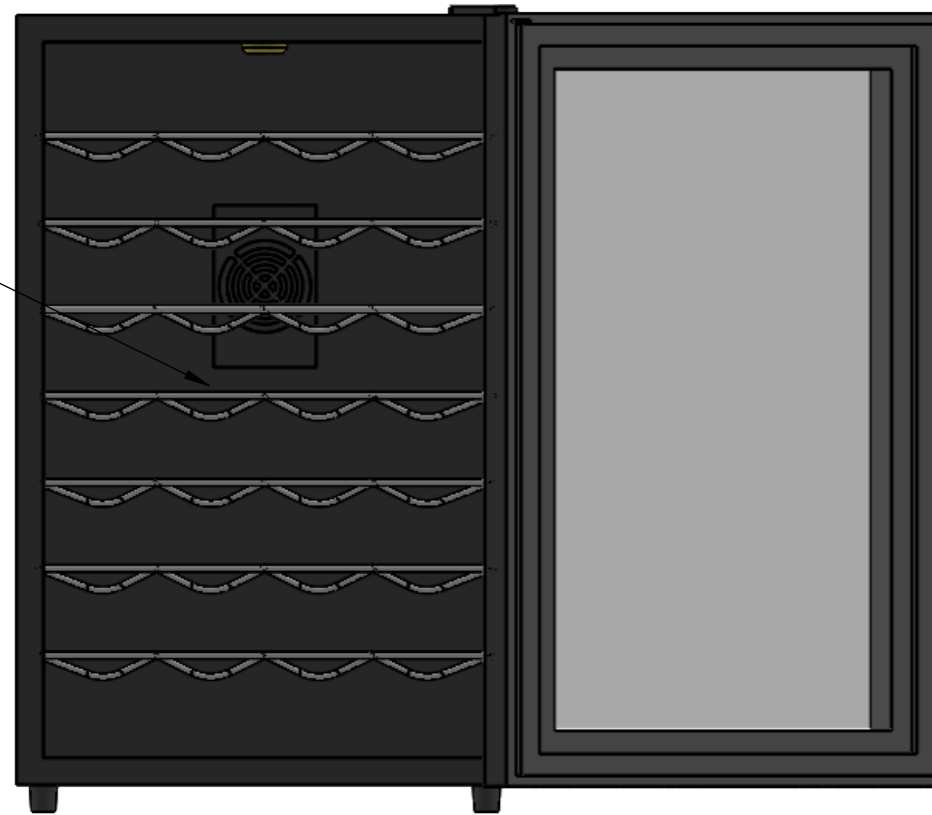

ALZADO

Ventilación

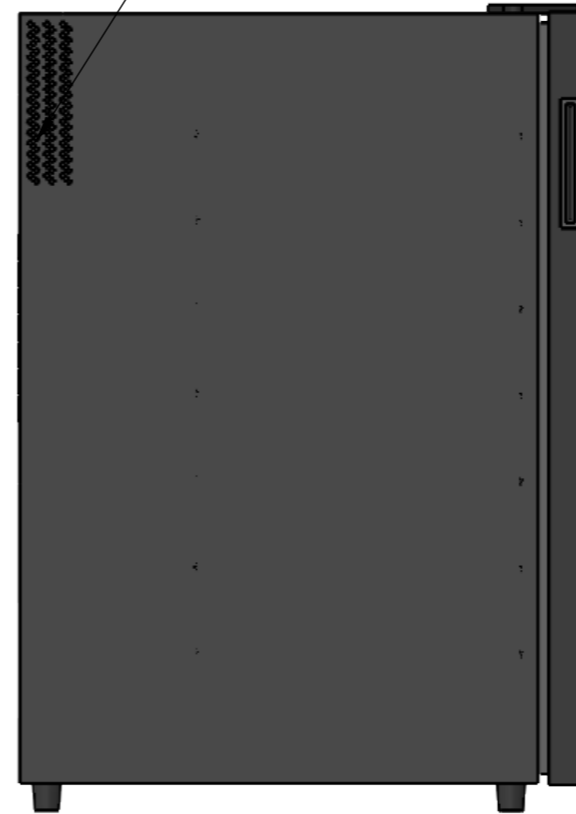

PERFIL

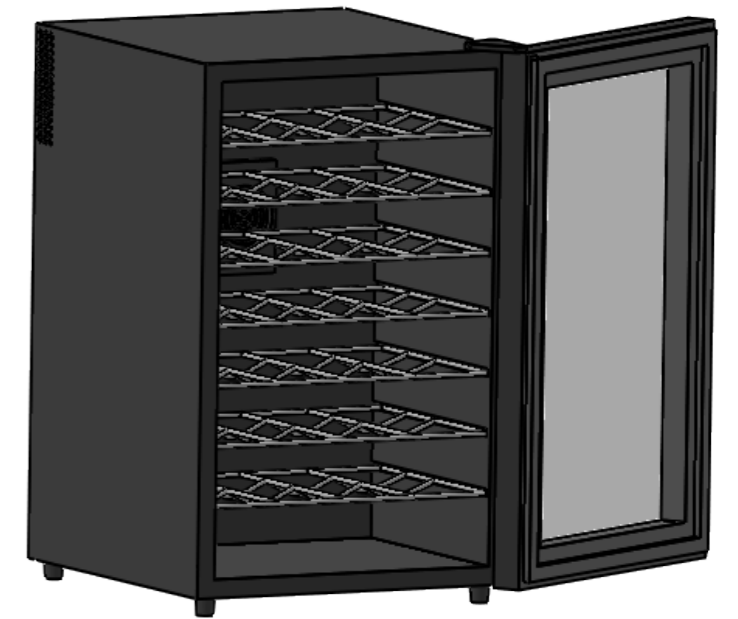

Ventilación

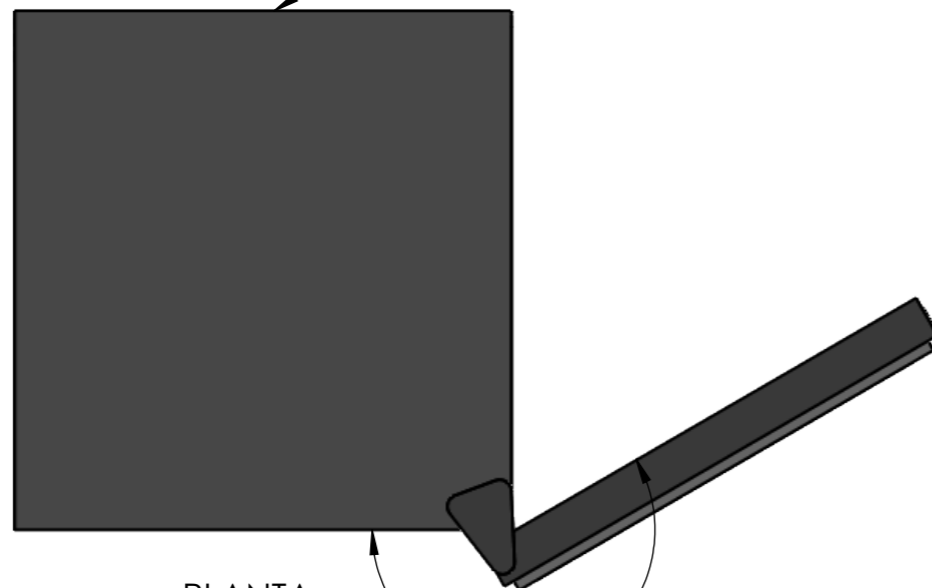

PLANTA

210°max. apertura

DATOS TÉCNICOS

Volumen	65L
Botellas	28
Frecuencia	50-60hz
Consumo	1 (15°C)kw/d
Voltaje	220/240-110/115V
Ruido	38db
Humedad interior	>70% RH
Sistema de frío	Termoeléctrico
Rango de temperatura	12-18°C

	Date	Name
Design:	03/12/2018	Diego
Checked:		Diego
Modified:		Diego
Scale: 1:10	Part name: CV028NS	
Unit:	Top assembly: CV028NS	

cavanoa

THE INFORMATION CONTAINED IN THIS DRAWING IS THE SOLE PROPERTY OF CAVANOVA WINE S.L. IN MÁLAGA, SPAIN. ANY REPRODUCTION IN PART OR AS A WHOLE WITHOUT THE WRITTEN PERMISSION OF CAVANOVA WINE S.L. IS PROHIBITED.

Sign:

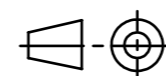

Description:
Vinoteca para 28botellas

Client:
Material:
Reference: CV028NS
Count:
Pages: 3 OF 4

MEDIDAS RECOMENDADAS	
ALTURA	795mm mín
PROFUNDIDAD	100mm mín (libre atrás)
ANCHURA	50mm por cada lado

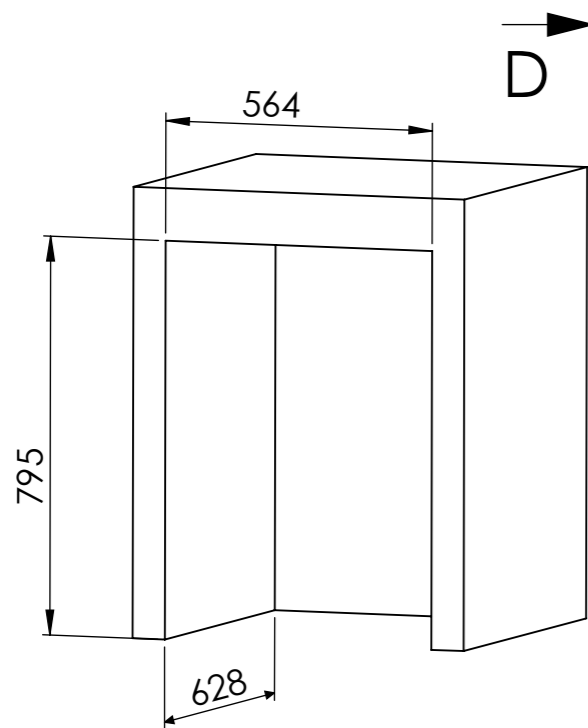
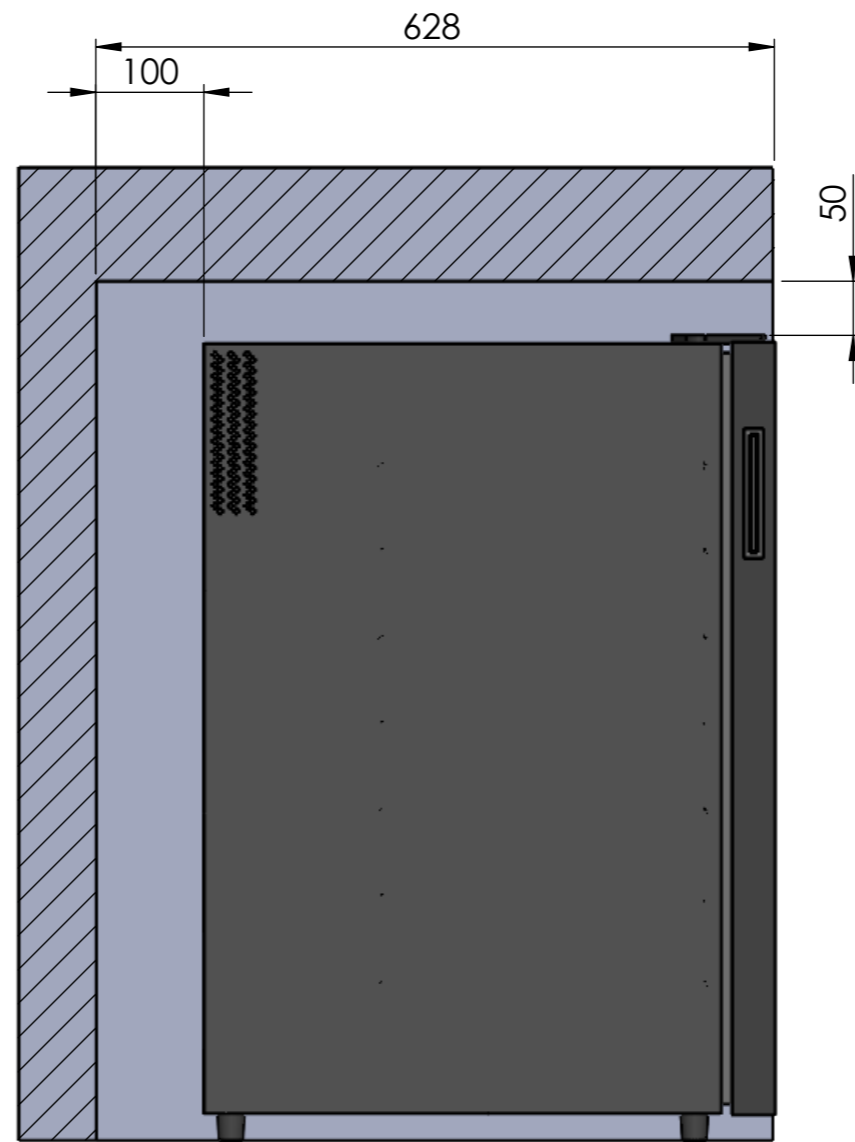
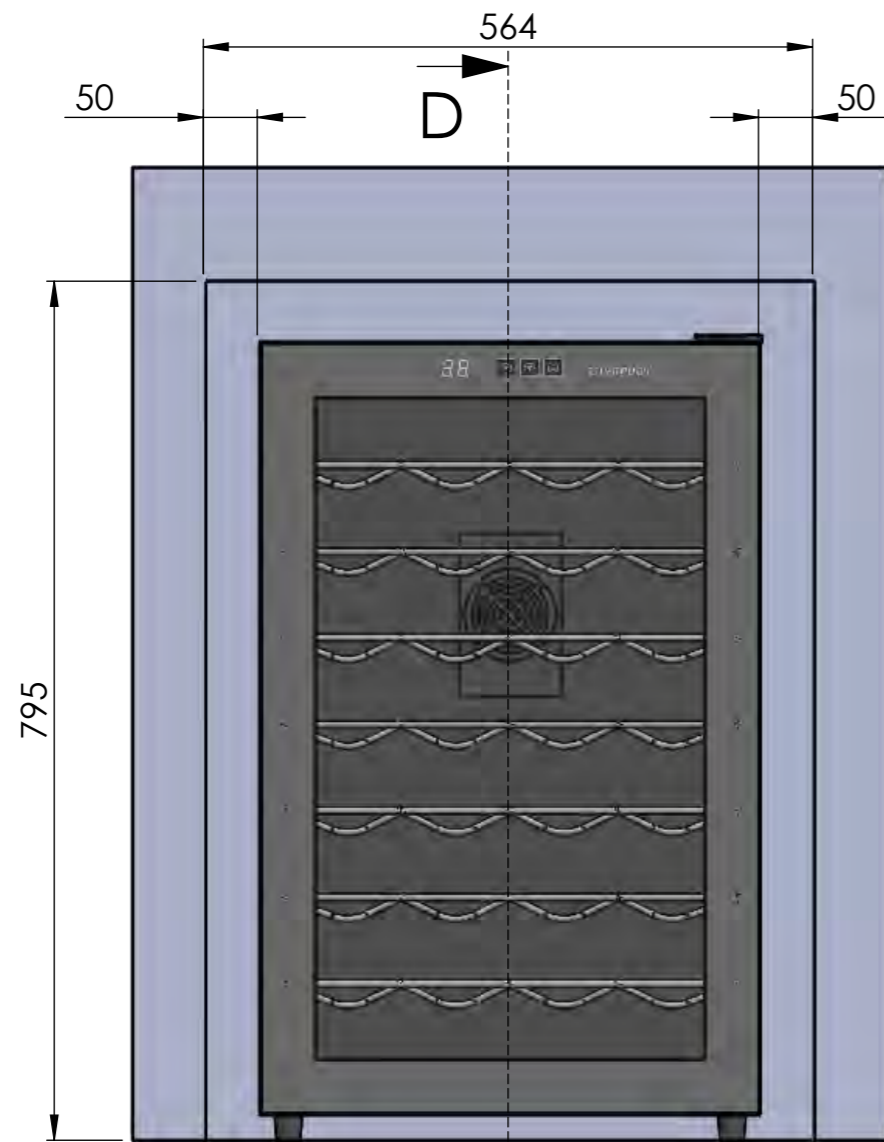

Medidas para hueco

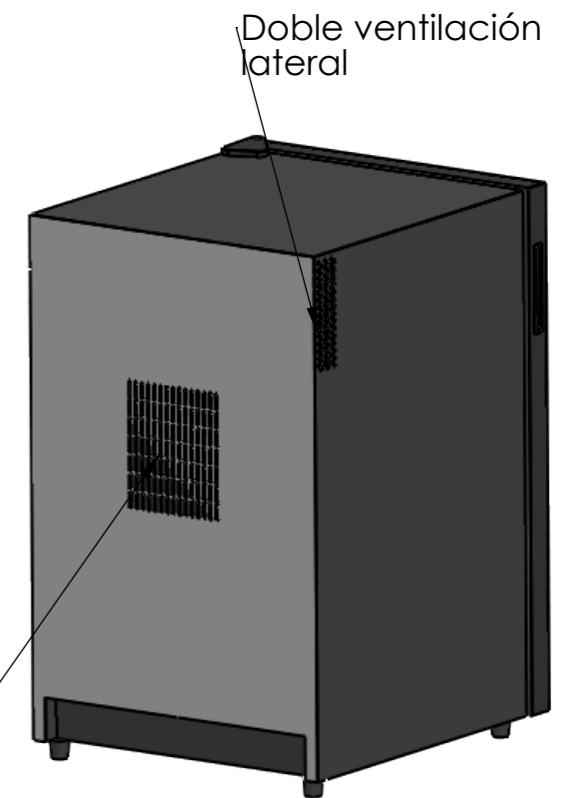

NO OBSTRUIR VENTILACIÓN

Date	Name	cavanova		
Design: 09/10/2018	Diego	<small>THE INFORMATION CONTAINED IN THIS DRAWING IS THE SOLE PROPERTY OF CAVANOVA WINE S.L. IN MÁLAGA, SPAIN. ANY REPRODUCTION IN PART OR AS A WHOLE WITHOUT THE WRITTEN PERMISSION OF CAVANOVA WINE S.L. IS PROHIBITED.</small>		
Checked:	Diego			
Modified:	Diego			
Scale: 1:10	Part name: CV028NS-ENTORNO	Top assembly: CV028NS	Client: Cavanova	
Unit: mm			Material: Varios	
	Description: Empotramiento del equipo (built-in)		Reference: CV028NS-ENTORNO	
			Count:	
			Pages: 4 OF 4	

Sign: