



Catálogo de las  
**MESAS PARA HOSTELERÍA**  
distribuidas en España

Este catálogo agrupa toda la información disponible sobre las [Mesas para Hostelería](#) que se distribuyen en España, según la facilitan sus respectivos fabricantes. Esta información incluye productos, modelos, características técnicas y precios.

Los precios indicados en este catálogo son los Precios de Venta Recomendados por cada fabricante, que puede haberlos actualizado, dejándolos obsoletos. Consúltanos el precio actual.

En todo caso, en la tienda online Hostelería10.com mejoramos con grandes descuentos los precios de todos los productos incluidos en este catálogo.

Las marcas de la sección Mesas para Hostelería que forman parte de este catálogo son:

Ezpeleta

Gayval

Hobeto

Muebles Romero

Resol

Ripay

Sólo una cuidada selección de los mejores productos de este catálogo están incluidos en Hostelería10.com.

Si tienes alguna duda respecto a alguno de estos productos o no encuentras el que buscas, escríbenos a [contacto@hosteleria10.com](mailto:contacto@hosteleria10.com) o llámanos al 91 161 03 04.

Estaremos encantados de atenderle.

## MEET

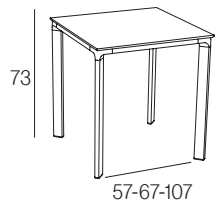

**70x70**

40MEE04	MHK-MEEC07004
40MEE08	MHK-MEEC07008
40MEE06	MHK-MEEC07006
40MEE05	MHK-MEEC07005
40MEE07	MHK-MEEC07007



**80x80**

40MEE14	MHK-MEEC08004
40MEE18	MHK-MEEC08008
40MEE16	MHK-MEEC08006
40MEE15	MHK-MEEC08005
40MEE17	MHK-MEEC08007



**90x90**

40MEE24	MHK-MEEC09004
-	-
40MEE26	MHK-MEEC09006
40MEE25	MHK-MEEC09005
-	-

- white
- sand
- taupe
- anthracite
- moka

Mesa apilable. Estructura de aluminio lacado. Perfil de 58x25x1,6mm con uniones en fundición de aluminio.

Mesa empilhável. Estrutura de alumínio lacado. Perfil de 58x25x1,6mm com uniões em alumínio fundido.

Stackable table. Lacquered aluminium frame. 58x25x1,6mm profiles with die cast aluminium links.

Table empilable. Structure en aluminium laque. Profile de 58x25x1,6mm avec des assemblages en fonte d'aluminium.



## MEET

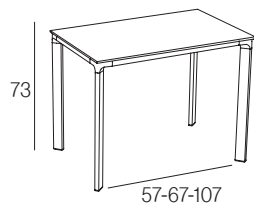

**120x80**

40MEE104	MHK-MEEH12004
40MEE108	MHK-MEEH12008
40MEE106	MHK-MEEH12006
40MEE105	MHK-MEEH12005
40MEE107	MHK-MEEH12007



**160x90**

40MEE204	MHK-MEEH16004
-	-
40MEE206	MHK-MEEH16006
40MEE205	MHK-MEEH16005
-	-



**200x90**

40MEE304	MHK-MEEH20004
-	-
40MEE306	MHK-MEEH20006
40MEE305	MHK-MEEH20005
-	-

- white
- sand
- taupe
- anthracite
- moka

Mesa dining. Estructura de aluminio lacado. Perfil de 58x25x1,6mm con uniones en fundición de aluminio.

Mesa dining. Estrutura de alumínio lacado. Perfil de 58x25x1,6mm com uniões em alumínio fundido.

Dinning table. Lacquered aluminium frame. 58x25x1,6mm profiles with die cast aluminium links.

Table dining. Structure en aluminium laque. Profile de 58x25x1,6mm avec des assemblages en fonte d'aluminium.



## QUATRO FIX

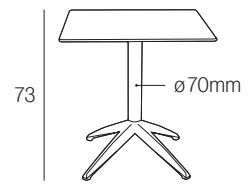

- white
- sand
- taupe
- anthracite
- moka



40QUF00



**60x60**

MHK-QUFC06000



**60x70**

MHK-QUFH06000



**70x70**

MHK-QUFC07000



**80x80**

MHK-QUFC08000



**ø60**

MHK-QUFR06000



**ø70**

MHK-QUFR07000

MHK-QUFC08004

MHK-QUFC08003

MHK-QUFC08001

MHK-QUFC08002

MHK-QUFR06004

MHK-QUFR06003

MHK-QUFR06001

MHK-QUFR06002

MHK-QUFR07004

MHK-QUFR07003

MHK-QUFR07001

MHK-QUFR07002

Mesa fija. Patas de polipropileno reforzado con fibra de vidrio. Tubo de aluminio lacado. Reguladores de altura.

Mesa fixa. Pés de polipropileno reforçado com fibra de vidro. Tubo de alumínio lacado. Reguladores de altura.

Fix table. Legs in Fiberglass reinforced polypropylene. Lacquered aluminium tube. Adjustable leveling feet.

Table fixe. Piétement en polypropylène renforcé avec fibre de verre. Tube aluminium laqué. Pieds sur vérins réglables.

Registered design No. 3184670

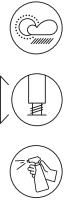

## QUATRO FOLD

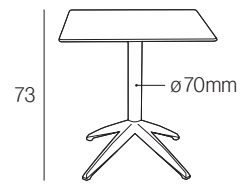

- white
- sand
- taupe
- anthracite
- moka



40QUA00



**60x60**

MHK-QUAC06000



**60x70**

MHK-QUAH06000



**70x70**

MHK-QUAC07000



**ø60**

MHK-QUAR06000



**ø70**

MHK-QUAR07000

MHK-QUAR06004

MHK-QUAR06003

MHK-QUAR06001

MHK-QUAR06002

MHK-QUAR07004

MHK-QUAR07003

MHK-QUAR07001

MHK-QUAR07002

Mesa abatible. Patas de polipropileno reforzado con fibra de vidrio. Tubo de aluminio lacado. Reguladores de altura.

Mesa rebatível. Pés de polipropileno reforçado com fibra de vidro. Tubo de alumínio lacado. Reguladores de altura.

Folding table. Legs in Fiberglass reinforced polypropylene. Lacquered aluminium tube. Adjustable leveling feet.

Table pliante. Piétement en polypropylène renforcé avec fibre de verre. Tube aluminium laqué. Pieds sur vérins réglables.

Registered design No. 3184670

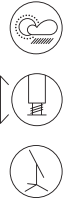

## QUATRO DUO FIX

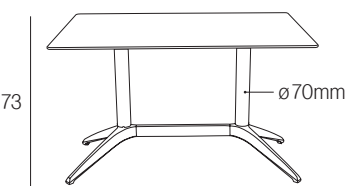

- white
- sand
- taupe
- anthracite
- moka



40QUF000



**120X80**

MHK-QUFH12000



**110X70**

MHK-QUFH11010

40QUF004

40QUF003

40QUF001

40QUF002

MHK-QUFH12004

MHK-QUFH12003

MHK-QUFH12001

MHK-QUFH12002

MHK-QUFH11014

MHK-QUFH11013

MHK-QUFH11011

MHK-QUFH11012



Mesa fija. Patas de polipropileno reforzado con fibra de vidrio. Tubo de aluminio lacado. Reguladores de altura.

Mesa fixa. Pés de polipropileno reforçado com fibra de vidro. Tubo de alumínio lacado. Reguladores de altura.

Fix table. Legs in Fiberglass reinforced polypropylene. Lacquered aluminium tube. Adjustable leveling feet.

Table fixe. Piétement en polypropylène renforcé avec fibre de verre. Tube aluminium laqué. Pieds sur vérins réglables.

Registered design No. 3184670

VIDEO INFO

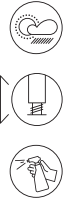



## QUATRO HIGH FIX

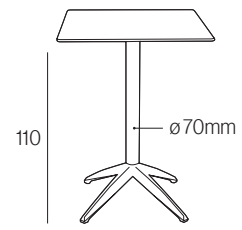

40QUF10  
40QUF14  
40QUF13  
40QUF11  
40QUF12



**60x60**  
MLK-QUFC06010  
MLK-QUFC06014  
MLK-QUFC06013  
MLK-QUFC06011  
MLK-QUFC06012



**60x70**  
MLK-QUFH06010  
MLK-QUFH06014  
MLK-QUFH06013  
MLK-QUFH06011  
MLK-QUFH06012



**70x70**  
MLK-QUFC07010  
MLK-QUFC07014  
MLK-QUFC07013  
MLK-QUFC07011  
MLK-QUFC07012



**ø60**  
MLK-QUFR06010  
MLK-QUFR06014  
MLK-QUFR06013  
MLK-QUFR06011  
MLK-QUFR06012



**ø70**  
MLK-QUFR07010  
MLK-QUFR07014  
MLK-QUFR07013  
MLK-QUFR07011  
MLK-QUFR07012

Mesa alta fija. Patas de polipropileno reforzado con fibra de vidrio. Tubo de aluminio lacado. Reguladores de altura. Pesos para mayor estabilidad.

Mesa alta fixa. Pés de polipropileno reforçado com fibra de vidro. Tubo de alumínio lacado. Reguladores de altura. Pesos para maior estabilidade.

High fix table. Legs in Fiberglass reinforced polypropylene. Lacquered aluminium tube. Adjustable leveling feet. Ballast to add stability.

Table haut fixe. Piètement en polypropylène renforcé avec fibre de verre. Tube aluminium laqué. Pieds sur vérins réglables. Lestes pour la stabilité.

Registered design No. 3184670

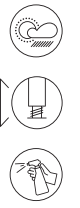

## QUATRO HIGH FOLD

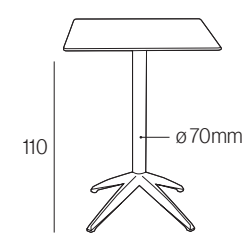

40QUA10  
40QUA14  
40QUA13  
40QUA11  
40QUA12



**60x60**  
MLK-QUAC06000  
MLK-QUAC06004  
MLK-QUAC06003  
MLK-QUAC06001  
MLK-QUAC06002



**ø60**  
MLK-QUAR06000  
MLK-QUAR06004  
MLK-QUAR06003  
MLK-QUAR06001  
MLK-QUAR06002

Mesa alta abatible. Patas de polipropileno reforzado con fibra de vidrio. Tubo de aluminio lacado. Reguladores de altura. Pesos para mayor estabilidad.

Mesa alta rebatível. Pés de polipropileno reforçado com fibra de vidro. Tubo de alumínio lacado. Reguladores de altura. Pesos para maior estabilidade.

High folding table. Legs in Fiberglass reinforced polypropylene. Lacquered aluminium tube. Adjustable leveling feet. Ballast to add stability.

Table haut pliante. Piètement en polypropylène renforcé avec fibre de verre. Tube aluminium laqué. Pieds sur vérins réglables. Lestes pour la stabilité.

Registered design No. 3184670

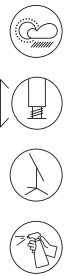

Ballast to add stability.



Adjustable leveling feet.



Tableros - Tamos - Table tops - Plateaux - Pag. 138 - 139

VIDEO INFO



## ONE

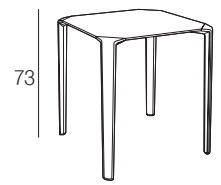

- white
- sand
- taupe
- anthracite
- moka
- cherry

	60x60	70x70	80x80	60x80
42ONE00	MHK-ONEC06000	MHK-ONEC07000	MHK-ONEC08000	MHK-ONEH06000
42ONE05	MHK-ONEC06005	MHK-ONEC07005	MHK-ONEC08005	MHK-ONEH06005
42ONE02	MHK-ONEC06002	MHK-ONEC07002	MHK-ONEC08002	MHK-ONEH06002
42ONE01	MHK-ONEC06001	MHK-ONEC07001	MHK-ONEC08001	MHK-ONEH06001
42ONE04	MHK-ONEC06004	MHK-ONEC07004	MHK-ONEC08004	MHK-ONEH06004
42ONE03	MHK-ONEC06003	MHK-ONEC07003	MHK-ONEC08003	MHK-ONEH06003

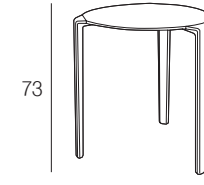

- white
- sand
- taupe
- anthracite
- moka
- cherry

	ø60	ø70
42ONE00	MHK-ONER06000	MHK-ONER07000
42ONE05	MHK-ONER06005	MHK-ONER07005
42ONE02	MHK-ONER06002	MHK-ONER07002
42ONE01	MHK-ONER06001	MHK-ONER07001
42ONE04	MHK-ONER06004	MHK-ONER07004
42ONE03	MHK-ONER06003	MHK-ONER07003

Mesa apilable. Patas de polipropileno reforzado con fibra de vidrio. Inyección por gas.

Mesa empilhável. Pés de polipropileno reforçado com fibra de vidro. Injeção por gás.

Stackable table. Legs in Fiberglass reinforced polypropylene. Gas injection.

Table empilable. Piètement en polypropylène renforcé avec fibre de verre. Injection par gaz.

Registered design No. 2747972

VIDEO INFO



## MONACO T

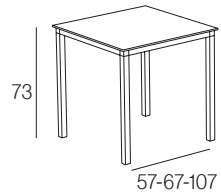

- white
- sand
- taupe
- anthracite
- moka

	70x70	80x80	
40MOT04	MHK-MOTC07004	40MOT14	MHK-MOTC08004
40MOT08	MHK-MOTC07008	40MOT18	MHK-MOTC08008
40MOT06	MHK-MOTC07006	40MOT16	MHK-MOTC08006
40MOT05	MHK-MOTC07005	40MOT15	MHK-MOTC08005
40MOT07	MHK-MOTC07007	40MOT17	MHK-MOTC08007



	120x80
40MOT104	MHK-MOTH12004
40MOT108	MHK-MOTH12008
40MOT106	MHK-MOTH12006
40MOT105	MHK-MKOTH12005
40MOT107	MHK-MOTH12007

Mesa apilable. Estructura de aluminio lacada con uniones de poliamida con fibra de vidrio. Reguladores de altura.

Mesa empilhável. Estrutura lacada com uniões em poliamida com fibra de vidro. Reguladores de altura.

Stackable table. Lacquered aluminium frame with polyamide with fiberglass connecting pieces. Adjustable leveling feet.

Table empilable. Structure en aluminium laqué avec assemblages en polyamide avec fibre de verre. Pieds sur vérins réglables.

Utility model No. U202030013

## URBAN T

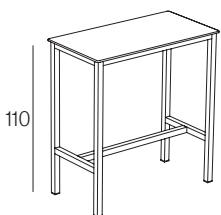

- taupe
- anthracite

	104X55
40URT07	MLK-URTH10407
40URT05	MLK-URTH10405



Mesa alta. Estructura de aluminio lacada con uniones de poliamida con fibra de vidrio. Reguladores de altura.

Mesa alta. Estrutura lacada com uniões em poliamida com fibra de vidro. Reguladores de altura.

High table. Lacquered aluminium frame with polyamide with fiberglass connecting pieces. Adjustable leveling feet.

Table haute. Structure en aluminium laqué avec assemblages en polyamide avec fibre de verre. Pieds sur vérins réglables.

Utility model No. U202030013

## KOS

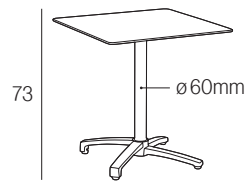

- white
- taupe
- anthracite



42KOS00  
42KOS01  
42KOS02



**60X60**  
MHK-KOSC06000  
MHK-KOSC06001  
MHK-KOSC06002



**60X70**  
MHK-KOSH06000  
MHK-KOSH06001  
MHK-KOSH06002



**70X70**  
MHK-KOSC07000  
MHK-KOSC07001  
MHK-KOSC07002



**Ø60**  
MHK-KOSR06000  
MHK-KOSR06001  
MHK-KOSR06002



**Ø70**  
MHK-KOSR07000  
MHK-KOSR07001  
MHK-KOSR07002

Mesa abatible. Pata aluminio lacado.  
Reguladores de altura.

Mesa rebatível. Pé alumínio lacado.  
Reguladores de altura.

Folding table. Lacquered aluminium leg.  
Adjustable leveling feet.

Table pliante. Pied aluminium laqué.  
Pieds sur vérins réglables.



## KOS DUO

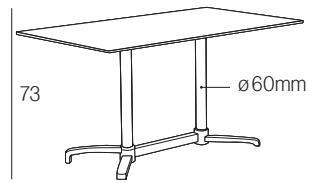

- white
- taupe
- anthracite



42KOS10  
42KOS11  
42KOS12



**120X80**  
MHK-KOSH120010  
MHK-KOSH120011  
MHK-KOSH120012



**110X70**  
MHK-KOSH110010  
MHK-KOSH110011  
MHK-KOSH110012



Mesa abatible. Pata aluminio lacado.  
Reguladores de altura.

Mesa rebatível. Pé alumínio lacado.  
Reguladores de altura.

Folding table. Lacquered aluminium leg.  
Adjustable leveling feet.

Table pliante. Pied aluminium laqué.  
Pieds sur vérins réglables.



## RODAS



- white
- sand
- taupe
- anthracite
- moka



40BRO01  
40SRO00  
40TRO00  
40ARO00  
40MRO00



**70x70**  
MHK-BROC07000  
MHK-SROC07000  
MHK-TROC07000  
MHK-AROC07000  
MHK-MROC07000

Mesa apilable. Tubo acero lacado.  
Mesa empilhável. Tubo aço lacado.

Stackable table. Lacquered steel tube.  
Table empilable. Tube acier laqué.



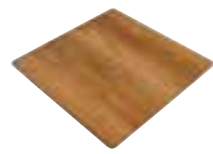

DARK OAK  
093K00

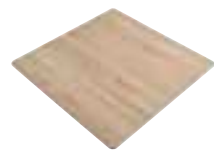

OAK  
092K00

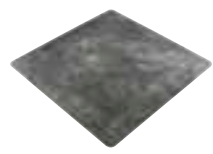

FACTORY  
017K00

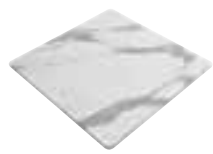

WHITE MARBLE  
013K00

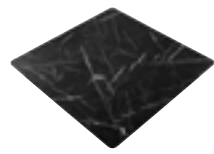

BLACK MARBLE  
094K00

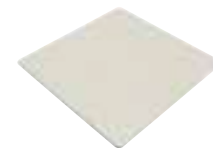

WOODSAND  
014K00



WHITE  
010K00

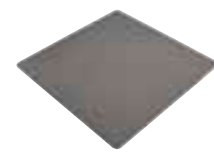

TAUPE  
020K00

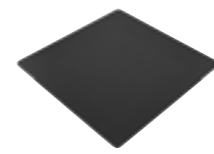

ANTHRACITE  
091K00



CONCRETE  
024K00



CORTEN  
023K00

60x60		45K00C06000-093K00	45K00C06000-092K00	45K00C06000-017K00	45K00C06000-013K00	45K00C06000-094K00
60x60 (one)		45K00C06001-093K00	45K00C06001-092K00	45K00C06001-017K00	45K00C06001-013K00	45K00C06001-094K00
70x70		45K00C07000-093K00	45K00C07000-092K00	45K00C07000-017K00	45K00C07000-013K00	45K00C07000-094K00
70x70 (one)		45K00C07001-093K00	45K00C07001-092K00	45K00C07001-017K00	45K00C07001-013K00	45K00C07001-094K00
80x80		45K00C08000-093K00	45K00C08000-092K00	45K00C08000-017K00	45K00C08000-013K00	45K00C08000-094K00
90x90						
80x80 (one)		45K00C08001-093K00	45K00C08001-092K00	45K00C08001-017K00	45K00C08001-013K00	45K00C08001-094K00
60x70		45K00H06002-093K00	45K00H06002-092K00	45K00H06002-017K00	45K00H06002-013K00	45K00H06002-094K00
110x70		45K00H11000-093K00	45K00H11000-092K00	45K00H11000-017K00	45K00H11000-013K00	45K00H11000-094K00
120x80		45K00H12000-093K00	45K00H12000-092K00	45K00H12000-017K00	45K00H12000-013K00	45K00H12000-094K00
104x55 (urban)		45K00H10400-093K00	45K00H10400-092K00	45K00H10400-017K00	45K00H10400-013K00	45K00H10400-094K00
160x90						
200x90						
ø60		45K00R06000-093K00	45K00R06000-092K00	45K00R06000-017K00	45K00R06000-013K00	45K00R06000-094K00
ø60 (one)		45K00R06001-093K00	45K00R06001-092K00	45K00R06001-017K00	45K00R06001-013K00	45K00R06001-094K00
ø70		45K00R07000-093K00	45K00R07000-092K00	45K00R07000-017K00	45K00R07000-013K00	45K00R07000-094K00
ø70 (one)		45K00R07001-093K00	45K00R07001-092K00	45K00R07001-017K00	45K00R07001-013K00	45K00R07001-094K00
60x80 (one)*		45K00H06001-093K00	45K00H06001-092K00			
45x45						

45K00C06000-014K00	45K00C06000-010K00	45K00C06000-020K00	45K00C06000-091K00	45K00C06000-024K00	45K00C06000-023K00
45K00C06001-014K00	45K00C06001-010K00	45K00C06001-020K00	45K00C06001-091K00	45K00C06001-024K00	45K00C06001-023K00
45K00C07000-014K00	45K00C07000-010K00	45K00C07000-020K00	45K00C07000-091K00	45K00C07000-024K00	45K00C07000-023K00
45K00C07001-014K00	45K00C07001-010K00	45K00C07001-020K00	45K00C07001-091K00	45K00C07001-024K00	45K00C07001-023K00
45K00C08000-014K00	45K00C08000-010K00	45K00C08000-020K00	45K00C08000-091K00	45K00C08000-024K00	45K00C08000-023K00
	45K00C09000-010K00	45K00C09000-020K00	45K00C09000-091K00		
45K00C08001-014K00	45K00C08001-010K00	45K00C08001-020K00	45K00C08001-091K00	45K00C08001-024K00	45K00C08001-023K00
45K00H06002-014K00	45K00H06002-010K00	45K00H06002-020K00	45K00H06002-091K00	45K00H06002-024K00	45K00H06002-023K00
45K00H11000-014K00	45K00H11000-010K00	45K00H11000-020K00	45K00H11000-091K00	45K00H11000-024K00	45K00H11000-023K00
45K00H12000-014K00	45K00H12000-010K00	45K00H12000-020K00	45K00H12000-091K00	45K00H12000-024K00	45K00H12000-023K00
45K00H10400-014K00	45K00H10400-010K00	45K00H10400-020K00	45K00H10400-091K00	45K00H10400-024K00	45K00H10400-023K00
	45K00H16001-010K00	45K00H16001-020K00	45K00H16001-091K00		
	45K00H20000-010K00	45K00H20000-020K00	45K00H20000-091K00		
45K00R06000-014K00	45K00R06000-010K00	45K00R06000-020K00	45K00R06000-091K00	45K00R06000-024K00	45K00R06000-023K00
45K00R06001-014K00	45K00R06001-010K00	45K00R06001-020K00	45K00R06001-091K00	45K00R06001-024K00	45K00R06001-023K00
45K00R07000-014K00	45K00R07000-010K00	45K00R07000-020K00	45K00R07000-091K00	45K00R07000-024K00	45K00R07000-023K00
45K00R07001-014K00	45K00R07001-010K00	45K00R07001-020K00	45K00R07001-091K00	45K00R07001-024K00	45K00R07001-023K00
45K00H06001-014K00	45K00H06001-010K00	45K00H06001-020K00	45K00H06001-091K00		45K00H06001-023K00
	45K00C04501-010K00	45K00C04501-020K00	45K00C04501-091K00		

## COMPACT

Tablero termolaminado compacto decorativo (10mm). Formado en la cara exterior por papel decorativo impregnado y en el interior por papel kraft impregnado con resinas termoestables. A este material se le aplica en la prensa temperatura y presión de forma simultánea para conseguir un tablero compacto de alta densidad.

*Tempo termolaminado compacto decorativo (10mm). A sua face exterior é formada por papel decorativo impregnado e o seu interior por papel kraft impregnado com resinas termoestáveis. O conjunto é prensado por meio de calor e alta pressão de forma simultânea para conseguir um tempo compacto de alta densidade.*

Decorative pressed laminated table top (10mm). Interior composed of thermostable resin kraft paper and surface lined with impregnated decorative paper. The compound is pressed simultaneously at high temperature and pressure to obtain a high density compacted table top.

*Plateau stratifié compact décoratif (10mm). Formé sur sa face extérieure par du papier décoratif imprégné et dans son intérieur par du papier kraft impregné avec des résines thermostables. L'ensemble est ensuite pressé sous l'action de la chaleur et de la haute pression, simultanément, afin d'obtenir un plateau compact de haute densité.*

\*No se recomiendan los colores oscuros para zonas muy soleadas - Não se recomendam cores escuras para zonas muito soalheiras - Dark colors are not recommended for very sunny areas - Les couleurs foncées ne sont pas recommandées pour les zones très ensoleillées

45X45 60x60 60x70 70x70 60x80 80x80 90x90 110x70 120x80 160x90 200x90 ø60 ø70 104x55

MEET			✓		✓	✓		✓	✓	✓			
QUATRO FIX		✓	✓	✓		✓					✓	✓	
QUATRO FOLD		✓	✓	✓							✓	✓	
QUATRO DUO FIX							✓	✓					
QUATRO HIGH FIX		✓	✓	✓							✓	✓	
QUATRO HIGH FOLD		✓									✓		
ONE		✓		✓	✓	✓					✓	✓	
MONACO T				✓		✓		✓					
URBAN													✓
KOS		✓	✓	✓							✓	✓	
KOS DUO							✓	✓					
RODAS				✓									
VILA	✓												

\* Hasta fin de existencias, Limitado ao stock existente, Up to end of stock, Jusqu'à fin de stocks.





## MESA VAN GOGH Fundición de Aluminio

- Ref. 2240 ▶ Ø80
- Ref. 2240 ▶ 60x60
- Ref. 2240 ▶ 70x70
- Ref. 2240 ▶ 80x80

SOLO	MADERA DE PINO O HAYA EN NOGAL	MELAMINA REGRUESADO	METAL MELAMINA	MELAMINA GAMA STUDIO VALKIRIA	GRANITO VERDE GRANITO NEGRO
184,80€	253,40€	Consultar precio			245,00€
184,80€	217,00€	175,00€	180,60€	183,40€	190,40€
200,20€	225,40€	184,80€	191,80€	197,40€	207,20€
212,80€	238,00€	196,00€	204,40€	211,40€	224,00€



## MESA RONDA Fundición de Aluminio

- Ref. 3004 ▶ Ø80
- Ref. 3004 ▶ 60x60
- Ref. 3004 ▶ 70x70
- Ref. 3004 ▶ 80x80

SOLO	MADERA DE PINO O HAYA EN NOGAL	MELAMINA REGRUESADO	METAL MELAMINA	MELAMINA GAMA STUDIO VALKIRIA	GRANITO VERDE GRANITO NEGRO
184,80€	253,40€	Consultar precio			245,00€
184,80€	217,00€	175,00€	180,60€	183,40€	190,40€
200,20€	225,40€	184,80€	191,80€	197,40€	207,20€
212,80€	238,00€	196,00€	204,40€	211,40€	224,00€



## MESA LORCA Hierro Forjado

- Ref. 5615 ▶ 100x60
- Ref. 5615 ▶ 110x70

SOLO	MELAMINA REGRUESADO	METAL MELAMINA	MELAMINA GAMA STUDIO VALKIRIA	GRANITO VERDE GRANITO NEGRO
201,60€				225,40€
231,00€	205,80€	215,60€	228,20€	246,40€



## MESA HAMBURGO Fundición de Hierro

- Ref. 8003 ▶ Ø60
- Ref. 8003 ▶ Ø70

SOLO	SOLO ARO LATÓN	MADERA DE PINO EN NOGAL	FORMICA COMPACT	MELAMINA REGRUESADO	METAL MELAMINA	MELAMINA GAMA STUDIO VALKIRIA
173,60€	306,60€	232,40€	208,60€	Consultar precio		
184,80€	345,80€	256,20€	231,00€	Consultar precio		



## MESA HAMBURGO Fundición de Hierro

- Ref. 8004 ▶ Ø80
- Ref. 8004 ▶ Ø90
- Ref. 8004 ▶ 60x60
- Ref. 8004 ▶ 70x70
- Ref. 8004 ▶ 80x80

SOLO	MADERA DE PINO O HAYA EN NOGAL	FORMICA COMPACT	MELAMINA REGRUESADO	METAL MELAMINA	MELAMINA GAMA STUDIO VALKIRIA
198,80€	284,20€		Consultar precio		
221,20€	312,20€		Consultar precio		
198,80€	238,00€	214,20€	186,20€	193,20€	196,00€
217,00€	249,20€	236,60€	198,80€	207,20€	214,20€
233,80€	264,60€	274,40€	212,80€	222,60€	231,00€



## MESA SANGHAI - V Acero Pintado Negro o Blanco



Ref. 866	▶ 60x60
Ref. 877	▶ 70x70
Ref. 888	▶ 80x80
Ref. 899	▶ 90x90
Ref. 811	▶ 110x70
Ref. 812	▶ 120x80

SOLO	FORMICA COMPACT	MELAMINA REGRUESADO	METAL MELAMINA	MELAMINA GAMA STUDIO VALKIRIA
247,80€	263,20€	235,20€	242,20€	245,00€
266,00€	285,60€	247,80€	256,20€	263,20€
282,80€	323,40€	261,80€	271,60€	280,00€
350,00€	Consultar Precio	291,20€	302,40€	315,00€
309,40€	362,60€	284,20€	294,00€	306,60€
340,20€	393,40€	302,40€	315,00€	327,60€

La mesa Sanghai de 200 x 90 lleva 2 pies en "V" (para tablero melamina regruesado de 38 mm), teniendo un precio de 672 €. Otras medidas consultar precio y tiempo de entrega.

## MESA SANGHAI Acero Pintado Negro o Blanco



Ref. 912	▶ 120x80
----------	----------

SOLO	FORMICA COMPACT	MELAMINA REGRUESADO	METAL MELAMINA	MELAMINA GAMA STUDIO VALKIRIA
343,00€	396,20€	305,20€	317,80€	330,40€

## MESA ALASKA Acero Pintado Negro



Ref. 8000	▶ 70x70
Ref. 8000	▶ 80x80
Ref. 8000	▶ 90x90
Ref. 8000	▶ 110x70
Ref. 8000	▶ 120x80

SOLO	FORMICA COMPACT	MELAMINA REGRUESADO	METAL MELAMINA	MELAMINA GAMA STUDIO VALKIRIA
245,00€	264,60€	226,80€	235,20€	242,20€
261,80€	302,40€	240,80€	250,60€	259,00€
322,00€	Consultar Precio	263,20€	274,40€	287,00€
292,60€	345,80€	267,40€	277,20€	289,80€
323,40€	376,60€	285,60€	298,20€	310,80€

## MESA ALASKA Acero Pintado Negro



Ref. 8000	▶ Ø80
Ref. 8000	▶ Ø90
Ref. 8000	▶ Ø100
Ref. 8000	▶ Ø110
Ref. 8000	▶ Ø120

FORMICA COMPACT	MELAMINA REGRUESADO	METAL MELAMINA	MELAMINA GAMA STUDIO VALKIRIA
296,80€	Consultar precio		
358,40€	Consultar precio		
473,20€	Consultar precio		
490,00€	Consultar precio		
508,20€	Consultar precio		

Tableros redondos, consultar precio y tiempo de entrega.

MESA PICASSO X-4 Baja Pie Acero Pintado Deco Madera Natural o Deco Madera Wengué



- Ref. 355 ▶ 50x50
- Ref. 360 ▶ Ø60
- Ref. 366 ▶ 60x60

SOLO	SOLO ARO LATÓN	FORMICA COMPACT	MELAMINA REGRUESADO	METAL MELAMINA	MELAMINA GAMA STUDIO VALKIRIA
		179,20€	151,20€	158,20€	161,00€
144,20€	277,20€	179,20€	Consultar precio		
163,80€		179,20€	151,20€	158,20€	161,00€

MESA PICASSO X-4 Baja Pie Acero Pintado Negro



- Ref. 355 ▶ 50x50
- Ref. 360 ▶ Ø60
- Ref. 366 ▶ 60x60

SOLO	SOLO ARO LATÓN	FORMICA COMPACT	MELAMINA REGRUESADO	METAL MELAMINA	MELAMINA GAMA STUDIO VALKIRIA
		170,80€	142,80€	149,80€	152,60€
135,80€	268,80€	170,80€	Consultar precio		
155,40€		170,80€	142,80€	149,80€	152,60€

MESA PICASSO X-4 Baja Pie Aluminio Pintado Gris o Blanco



- Ref. 355 ▶ 50x50
- Ref. 360 ▶ Ø60
- Ref. 366 ▶ 60x60

SOLO	SOLO ARO LATÓN	FORMICA COMPACT	MELAMINA REGRUESADO	METAL MELAMINA	MELAMINA GAMA STUDIO VALKIRIA
		193,20€	165,20€	172,20€	175,00€
158,20€	291,20€	193,20€	Consultar precio		
177,80€		193,20€	165,20€	172,20€	175,00€

## MESA PICASSO X-4 Pie Acero Pintado Deco Madera Natural



- Ref. 470 ▶ Ø70
- Ref. 480 ▶ Ø80
- Ref. 466 ▶ 60x60
- Ref. 477 ▶ 70x70

SOLO	SOLO ARO LATÓN	FORMICA COMPACT	MELAMINA REGRUESADO	METAL MELAMINA	MELAMINA GAMA STUDIO VALKIRIA
183,40€	344,40€	229,60€	Consultar precio		
191,80€			Consultar precio		
191,80€		207,20€	179,20€	186,20€	189,00€
210,00€		229,60€	191,80€	200,20€	207,20€

## MESA PICASSO X-4 Pie Acero Pintado Negro



- Ref. 470 ▶ Ø70
- Ref. 480 ▶ Ø80
- Ref. 466 ▶ 60x60
- Ref. 477 ▶ 70x70

SOLO	SOLO ARO LATÓN	FORMICA COMPACT	MELAMINA REGRUESADO	METAL MELAMINA	MELAMINA GAMA STUDIO VALKIRIA
175,00€	336,00€	221,20€	Consultar precio		
183,40€			Consultar precio		
183,40€		198,80€	170,80€	177,80€	180,60€
201,60€		221,20€	183,40€	191,80€	198,80€

## MESA COPENHAGEN Pie Acero Pintado Deco Madera Natural



- Ref. 770 ▶ Ø70
- Ref. 780 ▶ Ø80
- Ref. 766 ▶ 60x60
- Ref. 777 ▶ 70x70

SOLO	SOLO ARO LATÓN	FORMICA COMPACT	MELAMINA REGRUESADO	METAL MELAMINA	MELAMINA GAMA STUDIO VALKIRIA
183,40€	344,40€	229,60€	Consultar precio		
191,80€			Consultar precio		
191,80€		207,20€	179,20€	186,20€	189,00€
210,00€		229,60€	191,80€	200,20€	207,20€

## MESA COPENHAGEN Pie Acero Pintado Negro



- Ref. 770 ▶ Ø70
- Ref. 780 ▶ Ø80
- Ref. 766 ▶ 60x60
- Ref. 777 ▶ 70x70

SOLO	SOLO ARO LATÓN	FORMICA COMPACT	MELAMINA REGRUESADO	METAL MELAMINA	MELAMINA GAMA STUDIO VALKIRIA
175,00€	336,00€	221,20€	Consultar precio		
183,40€			Consultar precio		
183,40€		198,80€	170,80€	177,80€	180,60€
201,60€		221,20€	183,40€	191,80€	198,80€

MESA COLUMBIA Acero Pintado Negro



- Ref. 9000 ▶ Ø60
- Ref. 9000 ▶ Ø70
- Ref. 9000 ▶ Ø80
- Ref. 9000 ▶ Ø90

SOLO	SOLO ARO LATÓN	FORMICA COMPACT	MELAMINA REGRUESADO	METAL MELAMINA	MELAMINA GAMA STUDIO VALKIRIA
205,80€	338,80€	240,80€	Consultar precio		
217,00€	378,00€	263,20€	Consultar precio		
225,40€			Consultar precio		
247,80€			Consultar precio		

MESA COLUMBIA Acero Pintado Negro



- 9000 ▶ 60x60
- 9000 ▶ 70x70
- 9000 ▶ 80x80

SOLO	MADERA DE HAYA EN NOGAL	FORMICA COMPACT	MELAMINA REGRUESADO	METAL MELAMINA	MELAMINA GAMA STUDIO VALKIRIA
225,40€	264,60€	240,80€	212,80€	219,80€	222,60€
243,60€	275,80€	263,20€	225,40€	233,80€	240,80€
260,40€	291,20€	301,00€	239,40€	249,20€	257,60€

MESA COLUMBIA ALTA Acero Pintado Negro



- Ref. 9100 ▶ Ø60
- Ref. 9100 ▶ Ø70

SOLO	SOLO ARO LATÓN	FORMICA COMPACT	MELAMINA REGRUESADO	METAL MELAMINA	MELAMINA GAMA STUDIO VALKIRIA
219,80€	352,80€	254,80€	Consultar precio		
231,00€	392,00€	277,20€	Consultar precio		

MESA COLUMBIA ALTA Acero Pintado Negro



- Ref. 9100 ▶ 60x60
- Ref. 9100 ▶ 70x70

SOLO	MADERA DE HAYA EN NOGAL	FORMICA COMPACT	MELAMINA REGRUESADO	METAL MELAMINA	MELAMINA GAMA STUDIO VALKIRIA
239,40€	278,60€	254,80€	226,80€	233,80€	236,60€
257,60€	289,80€	277,20€	239,40€	247,80€	254,80€

## MESA EROS Acero Pintado Grafito o Negro



- Ref. 6772 ▶ 70x70
- Ref. 6882 ▶ 80x80
- Ref. 6992 ▶ 90x90

SOLO	FORMICA COMPACT	MELAMINA REGRUESADO	METAL MELAMINA	MELAMINA GAMA STUDIO VALKIRIA
196,00€	215,60€	177,80€	186,20€	193,20€
217,00€	257,60€	196,00€	205,80€	214,20€
287,00€	Consultar Precio	228,20€	239,40€	252,00€

## MESA EROS Acero Pintado Grafito o Negro



- Ref. 6112 ▶ 110x70
- Ref. 6112 ▶ 120x80

SOLO	FORMICA COMPACT	MELAMINA REGRUESADO	METAL MELAMINA	MELAMINA GAMA STUDIO VALKIRIA
249,20€	302,40€	224,00€	233,80€	246,40€
285,60€	338,80€	247,80€	260,40€	273,00€

## MESA EROS Armazón Acero Pintado Deco Madera Wengué y Patas Acero Pintado Deco Madera Wengué o Deco Madera Natural.



- Ref. 6772 ▶ 70x70
- Ref. 6882 ▶ 80x80
- Ref. 6992 ▶ 90x90

SOLO	FORMICA COMPACT	MELAMINA REGRUESADO	METAL MELAMINA	MELAMINA GAMA STUDIO VALKIRIA
207,20€	226,80€	189,00€	197,40€	204,40€
232,40€	273,00€	211,40€	221,20€	229,60€
305,20€	Consultar Precio	246,40	257,60€	270,20€

## MESA EROS Armazón Acero Pintado Deco Madera Wengué y Patas Acero Pintado Deco Madera Wengué o Deco Madera Natural.



- Ref. 6112 ▶ 110x70
- Ref. 6112 ▶ 120x80

SOLO	FORMICA COMPACT	MELAMINA REGRUESADO	METAL MELAMINA	MELAMINA GAMA STUDIO VALKIRIA
267,40€	320,60€	242,20€	252,00€	264,60€
303,80€	357,00€	266,00€	278,60€	291,20€

■ Mesas Eros versión Aluminio página 100.



### MESA MÍCHIGAN Acero Pintado Negro



75 cm.

- Ref. 4970 ▶ Ø60
- Ref. 4970 ▶ Ø70
- Ref. 4975 ▶ Ø80

SOLO	SOLO ARO LATÓN	FORMICA COMPACT	MELAMINA REGRUESADO	METAL MELAMINA	MELAMINA GAMA STUDIO VALKIRIA
151,20€	284,20€	186,20€	Consultar precio		
162,40€	323,40€	208,60€	Consultar precio		
184,80€			Consultar precio		

### MESA MÍCHIGAN Acero Pintado Negro



75 cm.

- Ref. 4970 ▶ 60x60
- Ref. 4970 ▶ 70x70
- Ref. 4975 ▶ 80x80
- Ref. 4975 ▶ 90x90

SOLO	FORMICA COMPACT	MELAMINA REGRUESADO	METAL MELAMINA	MELAMINA GAMA STUDIO VALKIRIA
170,80€	186,20€	158,20€	165,20€	168,00€
189,00€	208,60€	170,80€	179,20€	186,20€
219,80€	260,40€	198,80€	208,60€	217,00€
280,00€	Consultar Precio	221,20€	232,40€	245,00€

### MESA MÍCHIGAN Acero Pintado Negro



75 cm.

- Ref. 4971 ▶ 100x60
- Ref. 4971 ▶ 110x70
- Ref. 4971 ▶ 120x80

SOLO	FORMICA COMPACT	MELAMINA REGRUESADO	METAL MELAMINA	MELAMINA GAMA STUDIO VALKIRIA
235,20€				
264,60€	317,80€	239,40€	249,20€	261,80€
295,40€	348,60€	257,60€	270,20€	282,80€

### MESA MÍCHIGAN ALTA Acero Pintado Negro

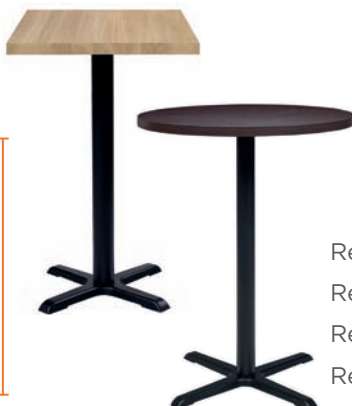

110 cm.

- Ref. 7970 ▶ Ø60
- Ref. 7970 ▶ 60x60
- Ref. 7975 ▶ Ø70
- Ref. 7975 ▶ 70x70

SOLO	SOLO ARO LATÓN	FORMICA COMPACT	MELAMINA REGRUESADO	METAL MELAMINA	MELAMINA GAMA STUDIO VALKIRIA
165,20€	298,20€	200,20€	Consultar precio		
184,80€		200,20€	172,20€	179,20€	182,00€
190,40€	351,40€	236,60€	Consultar precio		
217,00€		236,60€	198,80€	207,20€	214,20€

## MESA MILANO Acero Pintado Negro



75 cm.

- Ref. 4870 ▶ Ø60
- Ref. 4870 ▶ Ø70
- Ref. 4870 ▶ Ø80
- Ref. 4870 ▶ Ø90

SOLO	SOLO ARO LATÓN	MADERA DE PINO EN NOGAL	FORMICA COMPACT	MELAMINA REGRUESADO	METAL MELAMINA	MELAMINA GAMA STUDIO VALKIRIA
193,20€	326,20€	252,00€	228,20€	Consultar precio		
204,40€	365,40€	275,80€	250,60€	Consultar precio		
212,80€		298,20€		Consultar precio		
235,20€		326,20€		Consultar precio		

## MESA MILANO Acero Pintado Negro



75

- Ref. 4870 ▶ 60x60
- Ref. 4870 ▶ 70x70
- Ref. 4870 ▶ 80x80
- Ref. 4870 ▶ 90x90

SOLO	MADERA DE HAYA EN NOGAL	FORMICA COMPACT	MELAMINA REGRUESADO	METAL MELAMINA	MELAMINA GAMA STUDIO VALKIRIA
212,80€	252,00€	228,20€	200,20€	207,20€	210,00€
231,00€	263,20€	250,60€	212,80€	221,20€	228,20€
247,80€	278,60€	288,40€	226,80€	236,60€	245,00€
308,00€	292,60€	Consultar Precio	249,20€	260,40€	273,00€

## MESA MILANO ALTA Acero Pintado Negro



110 cm.

- Ref. 7870 ▶ Ø60
- Ref. 7870 ▶ Ø70

SOLO	SOLO ARO LATÓN	MADERA DE PINO EN NOGAL	FORMICA COMPACT	MELAMINA REGRUESADO	METAL MELAMINA	MELAMINA GAMA STUDIO VALKIRIA
207,20€	340,20€	266,00€	242,20€	Consultar precio		
218,40€	379,40€	289,80€	264,60€	Consultar precio		

## MESA MILANO ALTA Acero Pintado Negro



110 cm.

- Ref. 7870 ▶ 60x60
- Ref. 7870 ▶ 70x70

SOLO	MADERA DE HAYA EN NOGAL	FORMICA COMPACT	MELAMINA REGRUESADO	METAL MELAMINA	MELAMINA GAMA STUDIO VALKIRIA
226,80€	266,00€	242,20€	214,20€	221,20€	224,00€
245,00€	277,20€	264,60€	226,80€	235,20€	242,20€

MESA KOLONIA Acero Pintado Negro o Blanco



- Ref. 9201 ▶ Ø60
- Ref. 9201 ▶ Ø70
- Ref. 9201 ▶ Ø80
- Ref. 9201 ▶ 60x60
- Ref. 9201 ▶ 70x70
- Ref. 9252 ▶ 80x80

SOLO	SOLO ARO LATÓN	MADERA DE PINO O HAYA EN NOGAL	FORMICA COMPACT	MELAMINA REGRUESADO	METAL MELAMINA	MELAMINA GAMA STUDIO VALKIRIA
182,00€	315,00€	240,80€	217,00€	Consultar precio		
193,20€	354,20€	264,60€	239,40€	Consultar precio		
201,60€		287,00€		Consultar precio		
201,60€		240,80€	217,00€	189,00€	196,00€	198,80€
219,80€		252,00€	239,40€	201,60€	210,00€	217,00€
264,60€		295,40€	305,20€	243,60€	253,40€	261,80€

MESA KOLONIA ALTA Acero Pintado Negro o Blanco



- Ref. 9210 ▶ Ø60
- Ref. 9210 ▶ Ø70
- Ref. 9210 ▶ 60x60
- Ref. 9215 ▶ 70x70

SOLO	SOLO ARO LATÓN	MADERA DE PINO O HAYA EN NOGAL	FORMICA COMPACT	MELAMINA REGRUESADO	METAL MELAMINA	MELAMINA GAMA STUDIO VALKIRIA
196,00€	329,00€	254,80€	231,00€	Consultar precio		
207,20€	368,20€	278,60€	253,40€	Consultar precio		
215,60€		254,80€	231,00€	203,00€	210,00€	212,80€
261,80€		294,00€	281,40€	243,60€	252,00€	259,00€

MESA KOLONIA Acero Pintado Negro o Blanco



- Ref. 9202 ▶ 60x60
- Ref. 9202 ▶ 70x70
- Ref. 9202 ▶ 80x80
- Ref. 9052 ▶ 90x90

SOLO	MADERA DE HAYA EN NOGAL	FORMICA COMPACT	MELAMINA REGRUESADO	METAL MELAMINA	MELAMINA GAMA STUDIO VALKIRIA
201,60€	240,80€	217,00€	189,00€	196,00€	198,80€
219,80€	252,00€	239,40€	201,60€	210,00€	217,00€
236,60€	267,40€	277,20€	215,60€	225,40€	233,80€
324,80€	309,40€		266,00€	277,20€	289,80€

MESA KOLONIA ALTA Acero Pintado Negro o Blanco



- Ref. 9220 ▶ 60x60
- Ref. 9220 ▶ 70x70
- Ref. 9225 ▶ 80x80

SOLO	MADERA DE HAYA EN NOGAL	FORMICA COMPACT	MELAMINA REGRUESADO	METAL MELAMINA	MELAMINA GAMA STUDIO VALKIRIA
215,60€	254,80€	231,00€	203,00€	210,00€	212,80€
233,80€	266,00€	253,40€	215,60€	224,00€	231,00€
278,60€	309,40€	319,20€	257,60€	267,40€	275,80€

MESA KOLONIA Acero Pintado Negro o Blanco



- Ref. 9211 ▶ 100x60
- Ref. 9211 ▶ 110x70
- Ref. 9211 ▶ 120x80

SOLO	MADERA DE HAYA EN NOGAL	FORMICA COMPACT	MELAMINA REGRUESADO	METAL MELAMINA	MELAMINA GAMA STUDIO VALKIRIA
310,80€	351,40€				
340,20€	385,00€	393,40€	315,00€	324,80€	337,40€
371,00€	393,40€	424,20€	333,20€	345,80€	358,40€

MESA KOLONIA ALTA Acero Pintado Negro o Blanco



- Ref. 9222 ▶ 100x60
- Ref. 9222 ▶ 110x70
- Ref. 9222 ▶ 120x80

SOLO	MADERA DE HAYA EN NOGAL	FORMICA COMPACT	MELAMINA REGRUESADO	METAL MELAMINA	MELAMINA GAMA STUDIO VALKIRIA
338,80€	379,40€				
368,20€	413,00€	421,40€	343,00€	352,80€	365,40€
399,00€	421,40€	452,20€	361,20€	373,80€	386,40€

TODAS LAS MESAS KOLONIA CON **BASE DE 8MM DE GROSOR** Y CON COLUMNA REDONDA

Los precios pueden estar desactualizados. Llámamos al 91 161 03 04 para consultar los precios en vigor.

## MESA BAVIERA Acero Pintado Negro o Blanco



	SOLO	MADERA DE HAYA EN NOGAL	FORMICA COMPACT	MELAMINA REGRUESADO	METAL MELAMINA	MELAMINA GAMA STUDIO VALKIRIA
Ref. 9102 ▶ 60x60	207,20€	246,40€	222,60€	194,60€	201,60€	204,40€
Ref. 9102 ▶ 70x70	225,40€	257,60€	245,00€	207,20€	215,60€	222,60€
Ref. 9102 ▶ 80x80	242,20€	273,00€	282,80€	221,20€	231,00€	239,40€
Ref. 9152 ▶ 90x90	330,40€	315,00€	Consultar Precio	271,60€	282,80€	295,40€



## MESA BAVIERA ALTA Acero Pintado Negro o Blanco

	SOLO	MADERA DE HAYA EN NOGAL	FORMICA COMPACT	MELAMINA REGRUESADO	METAL MELAMINA	MELAMINA GAMA STUDIO VALKIRIA
Ref. 9120 ▶ 60x60	221,20€	260,40€	236,60€	208,60€	215,60€	218,40€
Ref. 9120 ▶ 70x70	239,40€	271,60€	259,00€	221,20€	229,60€	236,60€
Ref. 9115 ▶ 80x80	284,20€	315,00€	324,80€	263,20€	273,00€	281,40€

## MESA BAVIERA Acero Pintado Negro o Blanco



	SOLO	MADERA DE HAYA EN NOGAL	FORMICA COMPACT	MELAMINA REGRUESADO	METAL MELAMINA	MELAMINA GAMA STUDIO VALKIRIA
Ref. 9111 ▶ 100x60	323,40€	364,00€				
Ref. 9111 ▶ 110x70	352,80€	397,60 €	406,00€	327,60€	337,40€	350,00€
Ref. 9111 ▶ 120x80	383,60€	406,00€	436,80€	345,80€	358,40€	371,00€



## MESA BAVIERA ALTA Acero Pintado Negro o Blanco

	SOLO	MADERA DE HAYA EN NOGAL	FORMICA COMPACT	MELAMINA REGRUESADO	METAL MELAMINA	MELAMINA GAMA STUDIO VALKIRIA
Ref. 9122 ▶ 100x60	351,40€	392,00€				
Ref. 9122 ▶ 110x70	380,80€	425,60€	434,00€	355,60€	365,40€	378,00€
Ref. 9122 ▶ 120x80	411,60€	434,00€	464,80€	373,80€	386,40€	399,00€



TODAS LAS MESAS BAVIERA CON **BASE DE 8MM DE GROSOR** Y CON COLUMNA CUADRADA

Los precios pueden estar desactualizados. Llámanos al 91 161 03 04 para consultar los precios en vigor.

MESA MUNICH Aluminio y Aluminio pintado grafito, negro, gris o blanco.



	SOLO	FORMICA COMPACT	MELAMINA REGRUESADO	METAL MELAMINA	MELAMINA GAMA STUDIO VALKIRIA
Ref. 9805 ▶ 50x50		257,60€	229,60€	236,60€	239,40€
Ref. 9850 ▶ 60x60	242,20€	257,60€	229,60€	236,60€	239,40€
Ref. 9857 ▶ 70x70	260,40€	280,00€	242,20€	250,60€	257,60€

MESA MUNICH Aluminio y Aluminio pintado grafito, negro, gris o blanco.



	SOLO	FORMICA COMPACT	MELAMINA REGRUESADO	METAL MELAMINA	MELAMINA GAMA STUDIO VALKIRIA
Ref. 9866 ▶ 60x60	242,20€	257,60€	229,60€	236,60€	239,40€
Ref. 9877 ▶ 70x70	266,40€	280,00€	242,20€	250,60€	257,60€
Ref. 9888 ▶ 80x80	277,20€	317,80€	256,20€	266,00€	274,40€

Aluminio pintado negro.

Ref. 9855 ▶ 90x90	379,40	Consultar Precio	320,60	331,80	344,40
-------------------	--------	------------------	--------	--------	--------

MESA MUNICH Aluminio y Aluminio pintado grafito, negro, gris o blanco.



	SOLO	FORMICA COMPACT	MELAMINA REGRUESADO	METAL MELAMINA	MELAMINA GAMA STUDIO VALKIRIA
Ref. 9811 ▶ 100x60	390,60€				
Ref. 9811 ▶ 110x70	420,00€	473,20€	394,80€	404,60€	417,20€
Ref. 9811 ▶ 120x80	450,80€	504,00€	413,00€	425,60€	438,20€

Esta mesa se puede fabricar en altura 50 sin incrementar el precio

MESA MUNICH ALTA Aluminio y Aluminio pintado grafito, negro, gris o blanco.



	SOLO	FORMICA COMPACT	MELAMINA REGRUESADO	METAL MELAMINA	MELAMINA GAMA STUDIO VALKIRIA
Ref. 9186 ▶ 60x60	270,20€	285,60€	257,60€	264,60€	267,40€
Ref. 9187 ▶ 70x70	288,40€	308,00€	270,20€	278,60€	285,60€

MESA MUNICH ALTA Aluminio y Aluminio pintado grafito, negro, gris o blanco.



	SOLO	FORMICA COMPACT	MELAMINA REGRUESADO	METAL MELAMINA	MELAMINA GAMA STUDIO VALKIRIA
Ref. 9822 ▶ 100x60	446,60€				
Ref. 9822 ▶ 110x70	476,00€	529,20€	450,80€	460,60€	473,20€
Ref. 9822 ▶ 120x80	506,80€	560,00€	469,00€	481,60€	494,20€



## MESA GRAN ROMA Aluminio pintado grafito, negro, gris o blanco



- Ref. 9545 ▶ Ø60
- Ref. 9545 ▶ Ø70
- Ref. 9545 ▶ Ø80
- Ref. 9545 ▶ 60x60
- Ref. 9545 ▶ 70x70

SOLO	SOLO ARO LATÓN	MADERA DE PINO O HAYA EN NOGAL	FORMICA COMPACT	MELAMINA REGRUESADO	METAL MELAMINA	MELAMINA GAMA STUDIO VALKIRIA
218,40€	351,40€	277,20€	253,40€	Consultar precio		
229,60€	390,60€	301,00€	275,80€	Consultar precio		
238,00€		323,40€	Consultar precio			
238,00€		277,20€	253,40€	225,40€	232,40€	235,20€
256,20€		288,40€	275,80€	238,00€	246,40€	253,40€

Base Ø55 cm.

- Ref. 9800 ▶ 80x80

Aluminio pintado negro.

315,00€		345,80€	355,60€	294,00€	303,80€	312,20€
---------	--	---------	---------	---------	---------	---------

## MESA GRAN ROMA ALTA Aluminio pintado grafito, negro, gris o blanco.



- Ref. 9145 ▶ Ø60
- Ref. 9145 ▶ Ø70
- Ref. 9145 ▶ 60x60

SOLO	SOLO ARO LATÓN	MADERA DE PINO O HAYA EN NOGAL	FORMICA COMPACT	MELAMINA REGRUESADO	METAL MELAMINA	MELAMINA GAMA STUDIO VALKIRIA
246,40€	379,40€	305,20€	281,40€	Consultar precio		
257,60€	418,60€	329,00€	303,80€	Consultar precio		
266,00€		305,20€	281,40€	253,40€	260,40€	263,20€

## MESA GRAN ROMA Aluminio.



- Ref. 9545 ▶ Ø60
- Ref. 9545 ▶ Ø70
- Ref. 9545 ▶ Ø80
- Ref. 9545 ▶ 60x60
- Ref. 9545 ▶ 70x70

SOLO	SOLO ARO LATÓN	MADERA DE PINO O HAYA EN NOGAL	FORMICA COMPACT	MELAMINA REGRUESADO	METAL MELAMINA	MELAMINA GAMA STUDIO VALKIRIA
218,40€	351,40€	277,20€	253,40€	Consultar precio		
229,60€	390,60€	301,00€	275,80€	Consultar precio		
238,00€		323,40€	Consultar precio			
238,00€		277,20€	253,40€	225,40€	232,40€	235,20€
256,20€		288,40€	275,80€	238,00€	246,40€	253,40€

Base Ø55 cm.

- Ref. 9800 ▶ 80x80

## MESA GRAN ROMA ALTA Aluminio.



- Ref. 9145 ▶ Ø60
- Ref. 9145 ▶ Ø70
- Ref. 9145 ▶ 60x60

SOLO	SOLO ARO LATÓN	MADERA DE PINO O HAYA EN NOGAL	FORMICA COMPACT	MELAMINA REGRUESADO	METAL MELAMINA	MELAMINA GAMA STUDIO VALKIRIA
246,40€	379,40€	305,20€	281,40€	Consultar precio		
257,60€	418,60€	329,00€	303,80€	Consultar precio		
266,00€		305,20€	281,40€	253,40€	260,40€	263,20€

### MESA NÁPOLES Acero



Ref. 9650 ▶ Ø60  
Ref. 9650 ▶ Ø70

SOLO	SOLO ARO LATÓN	MADERA DE PINO EN NOGAL	FORMICA COMPACT
175,00€	308,00€	233,80€	210,00€
186,20€	347,20€	257,60€	232,40€

### MESA NÁPOLES Acero



Ref. 9650 ▶ 60x60  
Ref. 9650 ▶ 70x70

SOLO	MADERA DE HAYA EN NOGAL	FORMICA COMPACT	MELAMINA REGRUESADO	METAL MELAMINA	MELAMINA GAMA STUDIO VALKIRIA
194,60€	233,80€	210,00€	182,00€	189,00€	191,80€
212,80€	245,00€	232,40€	194,60€	203,00€	210,00€

### MESA Fundición de Hierro



Ref. 4550 ▶ Ø90  
Ref. 4550 ▶ Ø120  
Ref. 4550 ▶ 80x80  
Ref. 4550 ▶ 90x90

SOLO	MADERA DE PINO O HAYA EN NOGAL	FORMICA COMPACT	MELAMINA REGRUESADO	METAL MELAMINA	MELAMINA GAMA STUDIO VALKIRIA
254,80€	345,80€	Consultar precio			
350,00€	Consultar precio				
267,40€	298,20€	308,00€	246,40€	256,20€	264,60€
327,60€	312,20€	Consultar Precio	268,80€	280,00€	292,60€

La mesa Ref.4550 también se fabrica en gris, aumentando su precio en 5,60€

### MESA Columna de Fundición Torneada Fundición de Hierro



Ref. 4550T ▶ Ø90  
Ref. 4550T ▶ Ø120  
Ref. 4550T ▶ 80x80  
Ref. 4550T ▶ 90x90

SOLO	MADERA DE PINO O HAYA EN NOGAL	FORMICA COMPACT	MELAMINA REGRUESADO	METAL MELAMINA	MELAMINA GAMA STUDIO VALKIRIA
296,80€	387,80€	Consultar precio			
392,00€	Consultar precio				
309,40€	340,20€	350,00€	288,40€	298,20€	306,60€
369,60€	354,20€	Consultar Precio	310,80€	322,00€	334,60€

### MESA ALTA Fundición de Hierro



Ref. 7550 ▶ Ø70  
Ref. 7550 ▶ Ø80  
Ref. 7550 ▶ 70x70

SOLO	SOLO ARO LATÓN	MADERA DE PINO O HAYA EN NOGAL	FORMICA COMPACT	MELAMINA REGRUESADO	METAL MELAMINA	MELAMINA GAMA STUDIO VALKIRIA
238,00€	399,00€	309,40€	284,20€	Consultar precio		
246,40€	Consultar precio					
264,40€		296,80€	284,20€	246,00€	254,80€	261,80€

La mesa Ref. 7550 también se fabrica en gris, aumentando su precio en 7,00€

## MESA Fundición de Hierro



SOLO	SOLO ARO LATÓN	MADERA DE PINO O HAYA EN NOGAL	FORMICA COMPACT	MELAMINA REGRUESADO	METAL MELAMINA	MELAMINA GAMA STUDIO VALKIRIA
175,00€	308,00€	233,80€	210,00€	Consultar precio		
186,20€	347,20€	257,60€	232,40€	Consultar precio		
194,60€		280,00€	Consultar precio			
194,60€		233,80€	210,00€	182,00€	189,00€	191,80€
212,80€		245,00€	232,40€	194,60€	203,00€	210,00€

La mesa Ref.4150 también se fabrica en gris, aumentando su precio en 5,60€

## MESA Columna de Madera Fundición de Hierro



SOLO	SOLO ARO LATÓN	MADERA DE PINO O HAYA EN NOGAL	FORMICA COMPACT	MELAMINA REGRUESADO	METAL MELAMINA	MELAMINA GAMA STUDIO VALKIRIA
200,20€	333,20€	259,00€	235,20€	Consultar precio		
211,40€	372,40€	282,80€	257,60€	Consultar precio		
219,80€		305,20€	Consultar precio			
219,80€		259,00€	235,20€	207,20€	214,20€	217,00€
238,00€		270,20€	257,60€	219,80€	228,20€	235,20€

## MESA Columna de Madera Torneada Fundición de Hierro



SOLO	SOLO ARO LATÓN	MADERA DE PINO O HAYA EN NOGAL	FORMICA COMPACT	MELAMINA REGRUESADO	METAL MELAMINA	MELAMINA GAMA STUDIO VALKIRIA
200,20€	333,20€	259,00€	235,20€	Consultar precio		
211,40€	372,40€	282,80€	257,60€	Consultar precio		
219,80€		305,20€	Consultar precio			
219,80€		259,00€	235,20€	207,20€	214,20€	217,00€
238,00€		270,20€	257,60€	219,80€	228,20€	235,20€

## MESA Columna de Fundición Torneada Fundición de Hierro



SOLO	SOLO ARO LATÓN	MADERA DE PINO O HAYA EN NOGAL	FORMICA COMPACT	MELAMINA REGRUESADO	METAL MELAMINA	MELAMINA GAMA STUDIO VALKIRIA
207,20€	340,20€	266,00€	242,20€	Consultar precio		
218,40€	379,40€	289,80€	264,60€	Consultar precio		
226,80€		312,20€	Consultar precio			
226,80€		266,00€	242,20€	214,20€	221,20€	224,00€
245,00€		277,20€	264,60€	226,80€	235,20€	242,20€

## MESA ALTA Fundición de Hierro



SOLO	SOLO ARO LATÓN	MADERA DE PINO EN NOGAL	FORMICA COMPACT	MELAMINA REGRUESADO	METAL MELAMINA	MELAMINA GAMA STUDIO VALKIRIA
189,00€	322,00€	247,80€	224,00€	Consultar precio		
200,20€	361,20€	271,60€	246,40€	Consultar precio		

La mesa Ref. 7150 también se fabrica en gris, aumentando su precio en 7,00€

MESA Fundición de Hierro



SOLO	SOLO ARO LATÓN	MADERA DE PINO EN NOGAL	FORMICA COMPACT	MELAMINA REGRUESADO	METAL MELAMINA	MELAMINA GAMA STUDIO VALKIRIA
175,00€	308,00€	233,80€	210,00€	Consultar precio		
186,20€	347,20€	257,60€	232,40€	Consultar precio		
194,60€		280,00€		Consultar precio		

MESA Fundición de Hierro

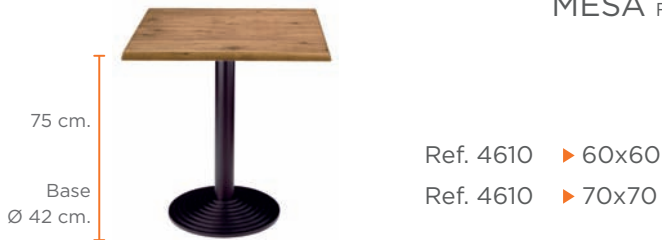

SOLO	MADERA DE HAYA EN NOGAL	FORMICA COMPACT	MELAMINA REGRUESADO	METAL MELAMINA	MELAMINA GAMA STUDIO VALKIRIA
194,60€	233,80€	210,00€	182,00€	189,00€	191,80€
212,80€	245,00€	232,40€	194,60€	203,00€	210,00€

MESA Columna de Madera Fundición de Hierro



SOLO	SOLO ARO LATÓN	MADERA DE PINO EN NOGAL	FORMICA COMPACT	MELAMINA REGRUESADO	METAL MELAMINA	MELAMINA GAMA STUDIO VALKIRIA
200,20€	333,20€	259,00€	235,20€	Consultar precio		
211,40€	372,40€	282,80€	257,60€	Consultar precio		
219,80€		305,20€		Consultar precio		

MESA Columna de Madera Fundición de Hierro



SOLO	MADERA DE HAYA EN NOGAL	FORMICA COMPACT	MELAMINA REGRUESADO	METAL MELAMINA	MELAMINA GAMA STUDIO VALKIRIA
219,80€	259,00€	235,20€	207,20€	214,20€	217,00€
238,00€	270,20€	257,60€	219,80€	228,20€	235,20€

MESA ALTA Fundición de Hierro



SOLO	SOLO ARO LATÓN	MADERA DE PINO EN NOGAL	FORMICA COMPACT	MELAMINA REGRUESADO	METAL MELAMINA	MELAMINA GAMA STUDIO VALKIRIA
189,00€	322,00€	247,80€	224,00€	Consultar precio		
200,20€	361,20€	271,60€	246,40€	Consultar precio		

## MESA ÉPOCA Fundición de Hierro

 <p>75 cm. Base 42x42 cm.</p>	<p>Ref. 4620 ▶ 60x60</p> <p>Ref. 4620 ▶ 70x70</p> <p>Ref. 4620 ▶ 80x80</p> <p>Ref. 4620 ▶ 90x90</p>	SOLO	MADERA DE HAYA EN NOGAL	FORMICA COMPACT	MELAMINA REGRUESADO	METAL MELAMINA	MELAMINA GAMA STUDIO VALKIRIA
		204,40€	243,60€	219,80€	191,80€	198,80€	201,60€
		222,60€	254,80€	242,20€	204,40€	212,80€	219,80€
		239,40€	270,20€	280,00€	218,40€	228,20€	236,60€
		299,60€	284,20€	Consultar Precio	240,80€	252,00€	264,60€

## MESA ÉPOCA Fundición de Hierro

 <p>75 cm. Base 42x42 cm.</p>	<p>Ref. 4620 ▶ Ø90</p> <p>Ref. 4620 ▶ Ø120</p>	SOLO	MADERA DE PINO EN NOGAL
		226,80€	317,80€
		322,00€	

## MESA ÉPOCA Fundición de Hierro

 <p>75 cm. Base 40x55 cm.</p>	<p>Ref. 4640 ▶ 100x60</p> <p>Ref. 4640 ▶ 110x70</p> <p>Ref. 4640 ▶ 120x80</p>	SOLO	MADERA DE HAYA EN NOGAL	FORMICA COMPACT	MELAMINA REGRUESADO	METAL MELAMINA	MELAMINA GAMA STUDIO VALKIRIA
		267,40€	308,00€				
		296,80€	341,60€	350,00€	271,60€	281,40€	294,00€
		327,60€	350,00€	380,80€	289,80€	302,40€	315,00€

Las mesas Ref. 4620 y Ref. 4640 se pueden configurar con columna de madera incrementando su precio 33,60€

## MESA ÉPOCA ALTA Fundición de Hierro

 <p>110 cm. Base 42x42 cm.</p>	<p>Ref. 7620 ▶ 60x60</p> <p>Ref. 7620 ▶ 70x70</p>	SOLO	MADERA DE HAYA EN NOGAL	FORMICA COMPACT	MELAMINA REGRUESADO	METAL MELAMINA	MELAMINA GAMA STUDIO VALKIRIA
		238,00€	277,20€	253,40€	225,40€	232,40€	235,20€
		256,20€	288,40€	275,80€	238,00€	246,40€	253,40€

## MESA ÉPOCA ALTA Columna de madera Fundición de Hierro

 <p>110 cm. Base 42x42 cm.</p>	<p>Ref. 7620M ▶ 60x60</p> <p>Ref. 7620M ▶ 70x70</p>	SOLO	MADERA DE HAYA EN NOGAL	FORMICA COMPACT	MELAMINA REGRUESADO	METAL MELAMINA	MELAMINA GAMA STUDIO VALKIRIA
		271,60€	310,80€	287,00€	259,00€	266,00€	268,80€
		289,80€	322,00€	309,40€	271,60€	280,00€	287,00€



MESA Fundición de Hierro



Ref. 4160 ▶ 60x60  
 Ref. 4160 ▶ 70x70  
 Ref. 4160 ▶ 80x80  
 Ref. 4160 ▶ 90x90

SOLO	MADERA DE HAYA EN NOGAL	FORMICA COMPACT	MELAMINA REGRUESADO	METAL MELAMINA	MELAMINA GAMA STUDIO VALKIRIA
204,40€	243,60€	219,80€	191,80€	198,80€	201,60€
222,60€	254,80€	242,20€	204,40€	212,80€	219,80€
239,40€	270,20€	280,00€	218,40€	228,20€	236,60€
299,60€	284,20€	Consultar Precio	240,80€	252,00€	264,60€

MESA Fundición de Hierro



Ref. 4160 ▶ Ø80  
 Ref. 4160 ▶ Ø90  
 Ref. 4160 ▶ Ø120

SOLO	MADERA DE PINO EN NOGAL
204,40€	289,80€
226,80€	317,80€
322,00€	

MESA Fundición de Hierro



Ref. 4140 ▶ 100x60  
 Ref. 4140 ▶ 110x70  
 Ref. 4140 ▶ 120x80

SOLO	MADERA DE HAYA EN NOGAL	FORMICA COMPACT	MELAMINA REGRUESADO	METAL MELAMINA	MELAMINA GAMA STUDIO VALKIRIA
267,40€	308,00€				
296,80€	341,60€	350,00€	271,60€	281,40€	294,00€
327,60€	350,00€	380,80€	289,80€	302,40€	315,00€

Las mesas Ref. 4160 y 4140 se pueden configurar con columna de madera incrementando su precio 33,60€

MESA ALTA Fundición de Hierro



Ref. 7660 ▶ 60x60  
 Ref. 7660 ▶ 70x70

SOLO	MADERA DE HAYA EN NOGAL	FORMICA COMPACT	MELAMINA REGRUESADO	METAL MELAMINA	MELAMINA GAMA STUDIO VALKIRIA
218,40€	257,60€	233,80€	205,80€	212,80€	215,60€
236,60€	268,80€	256,20€	218,40€	226,80€	233,80€

MESA ALTA Columna de Madera Fundición de Hierro



Ref. 7660M ▶ 60x60  
 Ref. 7660M ▶ 70x70

SOLO	MADERA DE HAYA EN NOGAL	FORMICA COMPACT	MELAMINA REGRUESADO	METAL MELAMINA	MELAMINA GAMA STUDIO VALKIRIA
252,00€	291,20€	267,40€	239,40€	246,40€	249,20€
270,20€	302,40€	289,80€	252,00€	260,40€	267,40€

## MESA OSLO Fundición de Hierro



SOLO	SOLO ARO LATÓN	MADERA DE PINO O HAYA EN NOGAL	FORMICA COMPACT	MELAMINA REGRUESADO	METAL MELAMINA	MELAMINA GAMA STUDIO VALKIRIA
170,80€	303,80€	229,60€	205,80€	Consultar precio		
182,00€	343,00€	253,40€	228,20€	Consultar precio		
190,40€		275,80€		Consultar precio		

## MESA OSLO Fundición de Hierro



SOLO	MADERA DE PINO O HAYA EN NOGAL	FORMICA COMPACT	MELAMINA REGRUESADO	METAL MELAMINA	MELAMINA GAMA STUDIO VALKIRIA
194,60€	280,00€		Consultar precio		
217,00€	280,00€		Consultar precio		
194,60€	233,80€	210,00€	182,00€	189,00€	191,80€
212,80€	245,00€	232,40€	194,60€	203,00€	210,00€
229,60€	260,40€	270,20€	208,60€	218,40€	226,80€
289,80€	274,40€	Consultar Precio	231,00€	242,20€	254,80€

Para configurar las mesas Oslo con Ref. 4770 y 4760 con columna de Madera incrementar el precio 25,20€ y para la Ref. 4780, 50,40€

## MESA OSLO Fundición de Hierro



SOLO	MADERA DE HAYA EN NOGAL	FORMICA COMPACT	MELAMINA REGRUESADO	METAL MELAMINA	MELAMINA GAMA STUDIO VALKIRIA
260,40€	301,00€				
289,80€	334,60€	343,00€	264,60€	274,40€	287,00€
320,60€	343,00€	373,80€	282,80€	295,40€	308,00€

## MESA OSLO ALTA Fundición de Hierro



SOLO	SOLO ARO LATÓN	MADERA DE PINO EN NOGAL	FORMICA COMPACT	MELAMINA REGRUESADO	METAL MELAMINA	MELAMINA GAMA STUDIO VALKIRIA
184,80€	317,80€	243,60€	219,80€	Consultar precio		

## MESA OSLO ALTA Fundición de Hierro



SOLO	SOLO ARO LATÓN	MADERA DE PINO O HAYA EN NOGAL	FORMICA COMPACT	MELAMINA REGRUESADO	METAL MELAMINA	MELAMINA GAMA STUDIO VALKIRIA
200,20€	361,20€	271,60€	246,40€	Consultar precio		
208,60€		247,80€	224,00€	196,00€	203,00€	205,80€
226,80€		259,00€	246,40€	208,60€	217,00€	224,00€

### MESA ORLEANS Columna de Fundición Torneada Fundición de Hierro



	SOLO	MADERA DE PINO O HAYA EN NOGAL	FORMICA COMPACT	MELAMINA REGRUESADO	METAL MELAMINA	MELAMINA GAMA STUDIO VALKIRIA
Ref. 8155T ▶ Ø80	235,20€	320,60€	Consultar precio			
Ref. 8155T ▶ Ø90	257,60€	348,60€	Consultar precio			
Ref. 8155T ▶ 60x60	235,20€	274,40€	250,60€	222,60€	229,60€	232,40€
Ref. 8155T ▶ 70x70	253,40€	285,60€	273,00€	235,20€	243,60€	250,60€
Ref. 8155T ▶ 80x80	270,20€	301,00€	310,80€	249,20€	259,00€	267,40€
Ref. 8155T ▶ 90x90	330,40€	315,00€	Consultar Precio	271,60€	282,80€	295,40€

### MESA ANTICUARIO Fundición de Hierro



	SOLO	MADERA DE PINO O HAYA EN NOGAL	FORMICA COMPACT	MELAMINA REGRUESADO	METAL MELAMINA	MELAMINA GAMA STUDIO VALKIRIA
Ref. 6004 ▶ Ø80	229,60€	315,00€	Consultar precio			
Ref. 6004 ▶ Ø90	252,00€	343,00€	Consultar precio			
Ref. 6004 ▶ Ø120	347,20€		Consultar precio			
Ref. 6004 ▶ 60x60	229,60€	268,80€	245,00€	217,00€	224,00€	226,80€
Ref. 6004 ▶ 70x70	247,80€	280,00€	267,40€	229,60€	238,00€	245,00€
Ref. 6004 ▶ 80x80	264,60€	295,40€	305,20€	243,60€	253,40€	261,80€
Ref. 6004 ▶ 90x90	324,80€	309,40€	Consultar Precio	266,00€	277,20€	289,80€

### MESA ANTICUARIO Fundición de Hierro



	SOLO	MADERA DE HAYA EN NOGAL	FORMICA COMPACT	MELAMINA REGRUESADO	METAL MELAMINA	MELAMINA GAMA STUDIO VALKIRIA
Ref. 6010 ▶ 100x60	327,60€	368,20€				
Ref. 6010 ▶ 110x70	357,00€	401,80€	410,20€	331,80€	341,60€	354,20€
Ref. 6010 ▶ 120x80	387,80€	410,20€	441,00€	350,00€	362,60€	375,20€

### MESA ANTICUARIO ALTA Fundición de Hierro



	SOLO	SOLO ARO LATÓN	MADERA DE PINO O HAYA EN NOGAL	FORMICA COMPACT	MELAMINA REGRUESADO	METAL MELAMINA	MELAMINA GAMA STUDIO VALKIRIA
Ref. 7164 ▶ Ø70	240,80€	401,80€	312,20€	287,00€	Consultar precio		
Ref. 7164 ▶ Ø80	249,20€		334,60€	Consultar precio			
Ref. 7164 ▶ 60x60	249,20€		288,40€	264,60€	236,60€	243,60€	246,40€
Ref. 7164 ▶ 70x70	267,40€		299,60€	287,00€	249,20€	257,60€	264,60€



## MESA PARISINO Fundición de Hierro

SOLO	SOLO ARO LATÓN	MADERA DE PINO EN NOGAL	FORMICA COMPACT	MELAMINA REGRUESADO	METAL MELAMINA	MELAMINA GAMA STUDIO VALKIRIA
179,20€	312,20€	238,00€	214,20€	Consultar precio		
190,40€	351,40€	261,80€	236,60€	Consultar precio		



## MESA PARÍS Fundición de Hierro

SOLO	SOLO ARO LATÓN	MADERA DE PINO EN NOGAL	FORMICA COMPACT	MELAMINA REGRUESADO	METAL MELAMINA	MELAMINA GAMA STUDIO VALKIRIA
194,60€	327,60€	253,40€	229,60€	Consultar precio		
205,80€	366,80€	277,20€	252,00€	Consultar precio		
214,20€		299,60€		Consultar precio		

## MESA PARÍS Fundición de Hierro



- Ref. 7004 ▶ Ø80
- Ref. 7004 ▶ Ø90
- Ref. 7004 ▶ 60x60
- Ref. 7004 ▶ 70x70
- Ref. 7004 ▶ 80x80
- Ref. 7004 ▶ 90x90

SOLO	MADERA DE PINO O HAYA EN NOGAL	FORMICA COMPACT	MELAMINA REGRUESADO	METAL MELAMINA	MELAMINA GAMA STUDIO VALKIRIA
219,80€	305,20€		Consultar precio		
242,20€	333,20€		Consultar precio		
219,80€	259,00€	235,20€	207,20€	214,20€	217,00€
238,00€	270,20€	257,60€	219,80€	228,20€	235,20€
254,80€	285,60€	295,40€	233,80€	243,60€	252,00€
315,00€	299,60€	Consultar Precio	256,20€	267,40€	280,00€



## MESA PARÍS ALTA Fundición de Hierro

SOLO	SOLO ARO LATÓN	MADERA DE PINO EN NOGAL	FORMICA COMPACT	MELAMINA REGRUESADO	METAL MELAMINA	MELAMINA GAMA STUDIO VALKIRIA
205,80€	338,80€	264,60€	240,80€	Consultar precio		
217,00€	378,00€	288,40€	263,20€	Consultar precio		



## MESA PARÍS ALTA Fundición de Hierro

- Ref. 7114 ▶ 60x60
- Ref. 7114 ▶ 70x70

SOLO	MADERA DE HAYA EN NOGAL	FORMICA COMPACT	MELAMINA REGRUESADO	METAL MELAMINA	MELAMINA GAMA STUDIO VALKIRIA
239,40€	278,60€	254,80€	226,80€	233,80€	236,60€
257,60€	289,80€	277,20€	239,40€	247,80€	254,80€

MESA GRECO Fundición de Hierro o Fundición Aluminio



SOLO	SOLO ARO LATÓN	MADERA DE PINO EN NOGAL	FORMICA COMPACT	MELAMINA REGRUESADO	METAL MELAMINA	MELAMINA GAMA STUDIO VALKIRIA
151,20€	257,60€	197,40€	179,20€	Consultar precio		
159,60€	288,40€	217,00€	196,00€	Consultar precio		
166,60€		235,20€		Consultar precio		

MESA GRECO Fundición de Hierro o Fundición Aluminio



SOLO	MADERA DE PINO O HAYA EN NOGAL	FORMICA COMPACT	MELAMINA REGRUESADO	METAL MELAMINA	MELAMINA GAMA STUDIO VALKIRIA
207,20€	280,00€		Consultar precio		
282,80€			Consultar precio		
189,00€	219,80€	201,60€	179,20€	184,80€	186,20€
203,00€	229,60€	218,40€	189,00€	196,00€	201,60€
217,00€	240,80€	249,20€	200,20€	207,20€	214,20€
264,60€	252,00€	Consultar Precio	218,40€	226,80€	236,60€

MESA GRECO Fundición Aluminio



SOLO	MADERA DE HAYA EN NOGAL	FORMICA COMPACT	MELAMINA REGRUESADO	METAL MELAMINA	MELAMINA GAMA STUDIO VALKIRIA
236,60€	268,80€				
260,40€	296,80€	302,40€	240,80€	247,80€	257,60€
285,60€	302,40€	327,60€	254,80€	264,60€	274,40€

MESA BULEVAR Fundición de Aluminio



SOLO	SOLO ARO LATÓN	MADERA DE PINO EN NOGAL	FORMICA COMPACT	MELAMINA REGRUESADO	METAL MELAMINA	MELAMINA GAMA STUDIO VALKIRIA
121,80€	228,20€	168,00€	149,80€	Consultar precio		
130,20€	259,00€	187,60€	168,00€	Consultar precio		

MESA BULEVAR Fundición de Aluminio



SOLO	MADERA DE PINO O HAYA EN NOGAL	FORMICA COMPACT	MELAMINA REGRUESADO	METAL MELAMINA	MELAMINA GAMA STUDIO VALKIRIA
161,00€	229,60€		Consultar precio		
161,00€	191,80€	173,60€	151,20€	156,80€	158,20€
175,00€	201,60€	190,40€	161,00€	168,00€	173,60€

## MESA MARBELLA Fundición de Hierro



Ref. 1003 ▶ Ø60  
Ref. 1003 ▶ Ø70  
Ref. 1003 ▶ Ø80

SOLO	SOLO ARO LATÓN	MADERA DE PINO EN NOGAL	FORMICA COMPACT	MELAMINA REGRUESADO	METAL MELAMINA	MELAMINA GAMA STUDIO VALKIRIA
180,60€	313,60€	239,40€	215,60€	Consultar precio		
191,80€	352,80€	263,20€	238,00€	Consultar precio		
200,20€		285,60€		Consultar precio		

## MESA MARBELLA Fundición de Hierro



Ref. 1004 ▶ Ø80  
Ref. 1004 ▶ Ø90

SOLO	MADERA DE PINO EN NOGAL	MELAMINA REGRUESADO	METAL MELAMINA	MELAMINA GAMA STUDIO VALKIRIA
225,40€	310,80€	Consultar precio		
247,80€	338,80€	Consultar precio		

## MESA MARBELLA Fundición de Hierro



Ref. 1004 ▶ 60x60  
Ref. 1004 ▶ 70x70  
Ref. 1004 ▶ 80x80  
Ref. 1004 ▶ 90x90

SOLO	MADERA DE HAYA EN NOGAL	FORMICA COMPACT	MELAMINA REGRUESADO	METAL MELAMINA	MELAMINA GAMA STUDIO VALKIRIA
225,40€	264,60€	240,80€	212,80€	219,80€	222,60€
243,60€	275,80€	263,20€	225,40€	233,80€	240,80€
260,40€	291,20€	301,00€	239,40€	249,20€	257,60€
320,60€	305,20€	Consultar Precio	261,80€	273,00€	285,60€

## MESA MARBELLA ALTA Fundición de Hierro



Ref. 7103 ▶ Ø60  
Ref. 7103 ▶ Ø70

SOLO	SOLO ARO LATÓN	MADERA DE PINO EN NOGAL	FORMICA COMPACT	MELAMINA REGRUESADO	METAL MELAMINA	MELAMINA GAMA STUDIO VALKIRIA
207,20€	340,20€	266,00€	242,20€	Consultar precio		
218,40€	379,40€	289,80€	264,60€	Consultar precio		

## MESA MARBELLA ALTA Fundición de Hierro



Ref. 7104 ▶ 60x60  
Ref. 7104 ▶ 70x70

SOLO	MADERA DE HAYA EN NOGAL	FORMICA COMPACT	MELAMINA REGRUESADO	METAL MELAMINA	MELAMINA GAMA STUDIO VALKIRIA
261,80€	301,00€	277,20€	249,20€	256,20€	259,00€
280,00€	312,20€	299,60€	261,80€	270,20€	277,20€



MESA GALA Bastidor Aluminio Pintado Negro Patas Haya



FORMICA <sup>®</sup> COMPACT 60x60	FORMICA <sup>®</sup> COMPACT 70x70	FORMICA <sup>®</sup> COMPACT 80x80	FORMICA <sup>®</sup> COMPACT 110x70	FORMICA <sup>®</sup> COMPACT 120x80
278,60€	301,00€	338,80€	379,40€	417,20€
Ref. 566	Ref. 577	Ref. 588	Ref. 511	Ref. 511

MESA GALA Bastidor Aluminio Pintado Blanco Patas Haya Lacado Blanco



FORMICA <sup>®</sup> COMPACT 60x60	FORMICA <sup>®</sup> COMPACT 70x70	FORMICA <sup>®</sup> COMPACT 80x80	FORMICA <sup>®</sup> COMPACT 110x70	FORMICA <sup>®</sup> COMPACT 120x80
292,60€	315,00€	352,80€	393,40€	431,20€
Ref. 566	Ref. 577	Ref. 588	Ref. 511	Ref. 511

MESA CÓNICA Madera regruessada en Haya



NOGAL 70x70	NOGAL 80x80	NOGAL 90x90	NOGAL 110x70	NOGAL 120x80
285,60€	301,00€	326,20€	371,00€	397,60€
Ref. 7702	Ref. 8802	Ref. 9902	Ref. 11002	Ref. 12002

MESA CLASSIC Madera regruessada en Haya



NOGAL 70x70	NOGAL 80x80	NOGAL 90x90	NOGAL 110x70	NOGAL 120x80
285,60€	301,00€	326,20€	371,00€	397,60€
Ref. 7700	Ref. 8800	Ref. 9900	Ref. 11000	Ref. 12000

MESA ESPACIO



MÉDULA ANTRACITA

90 x 50

247,80 €

Ref. 4290

MESA ESPACIO



MÉDULA ANTRACITA

69 x 69

240,80 €

Ref. 4240

MESA ESPACIO

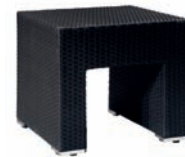

MÉDULA ANTRACITA

50 x 50

193,20 €

Ref. 4340

MESA ESPACIO



MÉDULA BLANCO

90 x 50

247,80 €

Ref. 4290

MESA ESPACIO



MÉDULA BLANCO

69 x 69

240,80 €

Ref. 4240

MESA ESPACIO



MÉDULA BLANCO

50 x 50

193,20 €

Ref. 4340

MESA ESPACIO



MÉDULA CAFÉ

90 x 50

247,80 €

Ref. 4290

MESA ESPACIO



MÉDULA CAFÉ

69 x 69

240,80 €

Ref. 4240

MESA ESPACIO



MÉDULA CAFÉ

50 x 50

193,20 €

Ref. 4340

MESA ESPACIO



MÉDULA MOKA

90 x 50

247,80 €

Ref. 4290

MESA ESPACIO



MÉDULA MOKA

69 x 69

240,80 €

Ref. 4240

MESA ESPACIO



MÉDULA MOKA

50 x 50

193,20 €

Ref. 4340

MESA ESPACIO



MÉDULA CENIZA

69 x 69

228,20 €

Ref. 4240

MESA ESPACIO



MÉDULA CENIZA

50 x 50

183,40 €

Ref. 4340

## MESA MUNICH Aluminio y Aluminio pintado grafito, negro, gris o blanco.



Ref. 9805 ▶ 50x50

Ref. 9850 ▶ 60x60

SOLO	FORMICA COMPACT
	257,60€
242,20€	257,60€

## MESA MUNICH Aluminio y Aluminio pintado grafito, negro, gris o blanco.



Ref. 9866 ▶ 60x60

Ref. 9877 ▶ 70x70

Ref. 9888 ▶ 80x80

Ref. 9855 ▶ 90x90

SOLO	FORMICA COMPACT
	257,60€
242,20€	257,60€
260,40€	280,00€
277,20€	317,80€
379,40€	Consultar Precio

## MESA MUNICH ALTA Aluminio y Aluminio pintado grafito, negro, gris o blanco.



Ref. 9186 ▶ 60x60

Ref. 9187 ▶ 70x70

SOLO	FORMICA COMPACT
	285,60€
270,20€	285,60€
288,40€	308,00€

## MESA MUNICH Aluminio y Aluminio pintado grafito, negro, gris o blanco.



Ref. 9811 ▶ 100x60

Ref. 9811 ▶ 110x70

Ref. 9811 ▶ 120x80

SOLO	FORMICA COMPACT
390,60€	
420,00€	473,20€
450,80€	504,00€

## MESA MUNICH ALTA Aluminio y Aluminio pintado grafito, negro, gris o blanco.



Ref. 9822 ▶ 100x60

Ref. 9822 ▶ 110x70

Ref. 9822 ▶ 120x80

SOLO	FORMICA COMPACT
446,60€	
476,00€	529,20€
506,80€	560,00€

 Bastidor de Aluminio para reforzar tablero:  
80x80 y 90x90 - 56 €

 Bastidor de Aluminio para reforzar tablero:  
110x70 y 120x80 - 63 €

Los precios pueden estar desactualizados. Llámamos al 91 161 03 04 para consultar los precios en vigor.

MESA MUNICH Columna Médula Antracita o Blanco



	SOLO	FORMICA COMPACT
Ref. 9866 ▶ 60x60	253,40€	268,80€
Ref. 9877 ▶ 70x70	271,60€	291,20€
Ref. 9888 ▶ 80x80	288,40€	329,00€
Ref. 9855 ▶ 90x90	390,60€	Consultar Precio

MESA MUNICH ALTA Columna Médula Antracita o Blanco



	SOLO	FORMICA COMPACT
Ref. 9186 ▶ 60x60	287,00€	302,40€
Ref. 9187 ▶ 70x70	305,20€	324,80€

MESA MUNICH Columna Médula Antracita o Blanco



	SOLO	FORMICA COMPACT
Ref. 9811 ▶ 100x60	413,00€	
Ref. 9811 ▶ 110x70	442,40€	495,60€
Ref. 9811 ▶ 120x80	473,20€	526,40€

MESA MUNICH ALTA Columna Médula Antracita o Blanco



	SOLO	FORMICA COMPACT
Ref. 9822 ▶ 100x60	480,20€	
Ref. 9822 ▶ 110x70	509,60€	562,80€
Ref. 9822 ▶ 120x80	540,40€	593,60€

MESA GRAN MUNICH ALTA Columna Médula Antracita

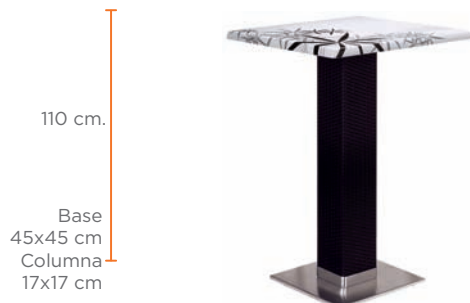

	SOLO	FORMICA COMPACT
Ref. 9188 ▶ 60x60	394,80€	410,20€
Ref. 9189 ▶ 70x70	413,00€	432,60€

 Bastidor de Aluminio para reforzar tablero: 80x80 y 90x90 - 56 €

 Bastidor de Aluminio para reforzar tablero: 110x70 y 120x80 - 63 €

Los precios pueden estar desactualizados. Llámamos al 91 161 03 04 para consultar los precios en vigor.

## MESA GRAN ROMA Aluminio



Ref. 9545 ▶ Ø60	
Ref. 9545 ▶ Ø70	
Ref. 9545 ▶ Ø80	
Ref. 9545 ▶ 60x60	
Ref. 9545 ▶ 70x70	

SOLO	FORMICA COMPACT
218,40€	253,40€
229,60€	275,80€
238,00€	Consultar Precio
238,00€	253,40€
256,20€	275,80€

Ref. 9800 ▶ 80x80	315,00€	355,60€
-------------------	---------	---------

## MESA GRAN ROMA ALTA Aluminio



Ref. 9145 ▶ Ø60	
Ref. 9145 ▶ Ø70	
Ref. 9145 ▶ 60x60	

SOLO	FORMICA COMPACT
246,40€	281,40€
257,60€	303,80€
266,00€	281,40€

## MESA ROMA Aluminio



Ref. 9550 ▶ Ø60	
Ref. 9550 ▶ Ø70	
Ref. 9550 ▶ Ø80	

INOX REPULSADO	SOLO	FORMICA COMPACT
187,60€	203,00€	238,00€
	214,20€	260,40€
	222,60€	Consultar Precio

## MESA ROMA ALTA Aluminio



Ref. 9150 ▶ Ø60	
Ref. 9150 ▶ Ø70	

INOX REPULSADO	SOLO	FORMICA COMPACT
203,00€	218,40€	253,40€
	229,60€	275,80€

## MESA ROMA Columna Médula Antracita, Café o Blanco



Ref. 9550 ▶ Ø60	
Ref. 9550 ▶ Ø70	
Ref. 9550 ▶ Ø80	

INOX REPULSADO	SOLO	FORMICA COMPACT
198,80€	214,20€	249,20€
	225,40€	271,60€
	233,80€	Consultar Precio



MESA ROMA ALTA Columna Médula Antracita, Café o Blanco

Ref. 9150 ▶ Ø60  
Ref. 9150 ▶ Ø70

INOX REPULSADO	SOLO	FORMICA COMPACT
219,80€	235,20€	270,20€
	246,40€	292,60€



MESA ROMA Aluminio

Ref. 9555 ▶ 60x60  
Ref. 9555 ▶ 70x70

SOLO	FORMICA COMPACT
233,80€	249,20€
252,00€	271,60€



MESA ROMA Columna Médula Antracita, Café o Blanco

Ref. 9555 ▶ 60x60  
Ref. 9555 ▶ 70x70

SOLO	FORMICA COMPACT
245,00€	260,40€
263,20€	282,80€



MESA ROMA ALTA Aluminio

Ref. 9155 ▶ 60x60  
Ref. 9155 ▶ 70x70

SOLO	FORMICA COMPACT
249,20€	264,60€
267,40€	287,00€



MESA ROMA ALTA Columna Médula Antracita, Café o Blanco

Ref. 9155 ▶ 60x60  
Ref. 9155 ▶ 70x70

SOLO	FORMICA COMPACT
266,00€	281,40€
284,20€	303,80€



## MESA NORUEGA ABATIBLE Aluminio Pintado Gris, Grafito, Negro, Blanco o Taupe



	SOLO	FORMICA COMPACT
Ref. 9466 ▶ 60x60	219,80€	235,20€
Ref. 9477 ▶ 70x70	238,00€	257,60€
Ref. 9488 ▶ 80x80	296,80€	337,40€

La mesa Noruega 80x80 lleva incorporados contrapesos, 4 unidades.

## MESA NORUEGA ABATIBLE ALTA Aluminio Pintado Gris, Grafito, Negro, Blanco o Taupe



	SOLO	FORMICA COMPACT
Ref. 9147 ▶ Ø60	214,20€	249,20€
Ref. 9147 ▶ Ø70	225,40€	271,60€
Ref. 9147 ▶ 60x60	233,80€	249,20€

Contrapesos, 4 unidades 42 €

## MESA NORUEGA ABATIBLE Aluminio Pintado Gris, Grafito, Negro, Blanco o Taupe



	SOLO	FORMICA COMPACT
Ref. 9411 ▶ 110x70	390,60€	443,80€
Ref. 9411 ▶ 120x80	421,40€	474,60€

## MESA FINLANDIA ABATIBLE Aluminio Pintado Grafito o Negro



	SOLO	FORMICA COMPACT
Ref. 5000 ▶ 60x60	222,60€	238,00€
Ref. 5000 ▶ 70x70	240,80€	260,40€
Ref. 5000 ▶ 80x80	257,60€	298,20€



MESA OSLO Aluminio Pintado Gris o Grafito

Ref. 9760 ▶ Ø60  
Ref. 9770 ▶ Ø70

INOX REPULSADO	SOLO	FORMICA COMPACT
145,60€	161,00€	196,00€
	172,20€	218,40€



MESA OSLO Aluminio Pintado Gris o Grafito

Ref. 9707 ▶ Ø70  
Ref. 9780 ▶ Ø80  
Ref. 9766 ▶ 60x60  
Ref. 9777 ▶ 70x70  
Ref. 9788 ▶ 80x80

SOLO	FORMICA COMPACT
183,40€	229,60€
191,80€	Consultar Precio
191,80€	207,20€
210,00€	229,60€
226,80€	267,40€



MESA OSLO ABATIBLE Aluminio Pintado Gris o Grafito

Ref. 9766AB ▶ 60x60  
Ref. 9777AB ▶ 70x70  
Ref. 9788AB ▶ 80x80

SOLO	FORMICA COMPACT
219,80€	235,20€
238,00€	257,60€
254,80€	295,40€



MESA OSLO Aluminio Pintado Gris o Grafito

Ref. 9711 ▶ 100x60  
Ref. 9711 ▶ 110x70  
Ref. 9711 ▶ 120x80

SOLO	FORMICA COMPACT
268,80€	
298,20€	351,40€
329,00€	382,20€

Contrapeso para pie Mod. Oslo Ref. 9760, 9770, 9707, 9780, 9766, 9777 y 9788: 22,40€  
Contrapeso para pie Mod. Oslo Ref. 9711: 44,80€



MESA OSLO ABATIBLE Aluminio Pintado Gris o Grafito

Ref. 9711AB ▶ 100x60  
Ref. 9711AB ▶ 110x70  
Ref. 9711AB ▶ 120x80

SOLO	FORMICA COMPACT
319,20€	
348,60€	401,80€
379,40€	432,60€

Contrapeso para pie Mod. Oslo Ref. 9760, 9770, 9707, 9780, 9766, 9777 y 9788: 22,40€  
Contrapeso para pie Mod. Oslo Ref. 9711: 44,80€

Bastidor de Aluminio para reforzar tablero:  
80x80 y 90x90 - 56 €

Bastidor de Aluminio para reforzar tablero:  
110x70 y 120x80 - 63 €

Los precios pueden estar desactualizados. Llámanos al 91 161 03 04 para consultar los precios en vigor.



MESA OSLO ALTA Aluminio Pintado Gris o Grafito

- Ref. 7760 ▶ Ø60
- Ref. 7770 ▶ Ø70
- Ref. 7766 ▶ 60x60

INOX REPULSADO	SOLO	FORMICA COMPACT
161,00€	176,40€	211,40€
	187,60€	233,80€
	196,00€	211,40€



MESA OSLO ALTA ABATIBLE Aluminio Pintado Gris o Grafito

- Ref. 7760AB ▶ Ø60
- Ref. 7770AB ▶ Ø70
- Ref. 7766AB ▶ 60x60

INOX REPULSADO	SOLO	FORMICA COMPACT
189,00€	204,40€	239,40€
	215,60€	261,80€
	224,00€	239,40€



MESA MANILA Aluminio Pintado Deco-Bambú

- Ref. 5370 ▶ Ø70
- Ref. 5380 ▶ Ø80
- Ref. 5377 ▶ 70x70
- Ref. 5388 ▶ 80x80

SOLO	FORMICA COMPACT
207,20€	253,40€
215,60€	Consultar Precio
233,80€	253,40€
250,60€	291,20€



MESA MANILA Aluminio Pintado Deco-Nogal

- Ref. 5370 ▶ Ø70
- Ref. 5380 ▶ Ø80
- Ref. 5377 ▶ 70x70
- Ref. 5388 ▶ 80x80

SOLO	FORMICA COMPACT
207,20€	253,40€
215,60€	Consultar Precio
233,80€	253,40€
250,60€	291,20€

MESA EROS Aluminio Pintado Gris, Negro, Grafito o Blanco



	SOLO	FORMICA COMPACT	MELAMINA REGRUESADO	METAL MELAMINA
Ref. 677 ▶ 70x70	226,80€	246,40€	208,60€	217,00€
Ref. 688 ▶ 80x80	245,00€	285,60€	224,00€	233,80€
Ref. 699 ▶ 90x90	312,20€	Consultar Precio	253,40€	264,60€

MESA EROS Aluminio Pintado Gris, Negro, Grafito o Blanco



	SOLO	FORMICA COMPACT	MELAMINA REGRUESADO	METAL MELAMINA
Ref. 611 ▶ 110x70	274,40€	327,60€	249,20€	259,00€
Ref. 611 ▶ 120x80	313,60€	366,80€	275,80€	288,40€

MESA EROS Aluminio, Armazón Negro y Patas Deco-Inox



	SOLO	FORMICA COMPACT	MELAMINA REGRUESADO	METAL MELAMINA
Ref. 650 ▶ 60x60	217,00€	232,40€	204,40€	211,40€

MESA EROS Aluminio, Armazón Negro y Patas Deco-Inox



	SOLO	FORMICA COMPACT	MELAMINA REGRUESADO	METAL MELAMINA
Ref. 666 ▶ 60x60	217,00€	232,40€	204,40€	211,40€
Ref. 677 ▶ 70x70	254,80€	274,40€	236,60€	245,00€
Ref. 688 ▶ 80x80	273,00€	313,60€	252,00€	261,80€
Ref. 699 ▶ 90x90	340,20€	Consultar Precio	281,40€	292,60€



MESA EROS Aluminio, Armazón Negro y Patas Deco-Inox

	SOLO	FORMICA COMPACT	MELAMINA REGRUESADO	METAL MELAMINA
Ref. 611 ▶ 110x70	302,40€	355,60€	277,20€	287,00€
Ref. 611 ▶ 120x80	341,60€	394,80€	303,80€	316,40€

MESAS CON TABLERO MELAMINA O METALMELAMINA SÓLO PARA USO INTERIOR.



## MESA EROS Aluminio, Armazón y patas Pintadas Deco-Bambú

	SOLO	FORMICA COMPACT	MELAMINA REGRUESADO	METAL MELAMINA
Ref. 677 ▶ 70x70	239,40€	259,00€	221,20€	229,60€
Ref. 688 ▶ 80x80	257,60€	298,20€	236,60€	246,40€



## MESA EROS Aluminio, Armazón y patas Pintadas Deco-Bambú

	SOLO	FORMICA COMPACT	MELAMINA REGRUESADO	METAL MELAMINA
Ref. 611 ▶ 120x80	326,20€	379,40€	288,40€	301,00€



## MESA EROS Aluminio, Armazón Negro y Patas Pintadas Deco-Nogal.

	SOLO	FORMICA COMPACT	MELAMINA REGRUESADO	METAL MELAMINA
Ref. 677 ▶ 70x70	239,40€	259,00€	221,20€	229,60€
Ref. 688 ▶ 80x80	257,60€	298,20€	236,60€	246,40€
Ref. 699 ▶ 90x90	324,80€	Consultar Precio	266,00€	277,20€



## MESA EROS Aluminio, Armazón Negro y Patas Pintadas Deco-Nogal.

	SOLO	FORMICA COMPACT	MELAMINA REGRUESADO	METAL MELAMINA
Ref. 611 ▶ 110x70	287,00€	340,20€	261,80€	271,60€
Ref. 611 ▶ 120x80	326,20€	379,40€	288,40€	301,00€

MESAS CON TABLERO MELAMINA O METALMELAMINA SÓLO PARA USO INTERIOR.

MESA BALI Pie Mesa Médula Blanco



	SOLO
Ref. 5088 ▶ 80x80	291,20€
Ref. 5088 ▶ 90x90	351,40€
Ref. 5088 ▶ 120x80	341,60€
Ref. 5088 ▶ Ø120	373,80€

MESA BALI Pie Mesa Médula Atracita



	SOLO
Ref. 5088 ▶ 80x80	291,20€
Ref. 5088 ▶ 90x90	351,40€
Ref. 5088 ▶ 120x80	341,60€
Ref. 5088 ▶ Ø120	373,80€

MESA MIRÓ Aluminio Pintado Grafito



	SOLO
Ref. 5540P ▶ Ø80	166,60€
Ref. 5540P ▶ Ø90	189,00€

MESA MIRÓ Aluminio Pintado Grafito



	SOLO	FORMICA COMPACT
Ref. 5540 ▶ 70x70	193,20€	212,80€
Ref. 5540 ▶ 80x80	210,00€	250,60€
Ref. 5540 ▶ 90x90	326,20€	Consultar Precio
Ref. 5540 ▶ Ø120	348,60€	Consultar Precio

Las mesas 90x90 y Ø120 llevan armazón bajo tapa.

MESA MIRÓ Aluminio Pintado Grafito



	SOLO	FORMICA COMPACT
Ref. 5510 ▶ 110x70	316,40€	306,60€
Ref. 5510 ▶ 120x80	347,20€	337,40€

Estas mesas llevan armazón bajo tapa, excepto compact .

 Bastidor de Aluminio para reforzar tablero: 80x80 y 90x90 - 56 €

Los precios pueden estar desactualizados. Llámanos al 91 161 03 04 para consultar los precios en vigor.





## MESA SUECIA Aluminio

Ref. 9360 ▶ Ø60  
Ref. 9370 ▶ Ø70

SOLO	FORMICA COMPACT
208,60€	243,60€
219,80€	266,00€



## MESA SUECIA Aluminio

Ref. 9307 ▶ Ø70  
Ref. 9380 ▶ Ø80  
Ref. 9390 ▶ Ø90

SOLO	FORMICA COMPACT
228,20€	274,40€
236,60€	Consultar Precio
259,00€	Consultar Precio



## MESA SUECIA Aluminio

Ref. 9366 ▶ 60x60  
Ref. 9377 ▶ 70x70  
Ref. 9388 ▶ 80x80  
Ref. 9399 ▶ 90x90

SOLO	FORMICA COMPACT
236,60€	252,00€
254,80€	274,40€
271,60€	312,20€
331,80€	Consultar Precio



## MESA SUECIA ABATIBLE Aluminio

Ref. 9366AB ▶ 60x60  
Ref. 9377AB ▶ 70x70  
Ref. 9388AB ▶ 80x80

SOLO	FORMICA COMPACT
261,80€	277,20€
280,00€	299,60€
296,80€	337,40€



## MESA SUECIA Aluminio

Ref. 9311 ▶ 110x70  
Ref. 9311 ▶ 120x80

SOLO	FORMICA COMPACT
331,80€	385,00€
362,60€	415,80€



## MESA SUECIA ABATIBLE Aluminio

Ref. 9311AB ▶ 110x70  
Ref. 9311AB ▶ 120x80

SOLO	FORMICA COMPACT
382,20€	435,40€
413,00€	466,20€



Bastidor de Aluminio para reforzar tablero:  
110x70 y 120x80 - 63 €

Los precios pueden estar desactualizados. Llámanos al 91 161 03 04 para consultar los precios en vigor.

75 cm.



MESA SUECIA Columna Médula Antracita, Café o Blanco

- Ref. 9360 ▶ Ø60
- Ref. 9370 ▶ Ø70

SOLO	FORMICA COMPACT
219,80€	254,80€
231,00€	277,20€

75 cm.



MESA SUECIA Columna Médula Antracita, Café o Blanco

- Ref. 9307 ▶ Ø70
- Ref. 9380 ▶ Ø80
- Ref. 9390 ▶ Ø90

SOLO	FORMICA COMPACT
239,40€	285,60€
247,80€	Consultar Precio
270,20€	Consultar Precio

75 cm.



MESA SUECIA Columna Médula Antracita, Café o Blanco

- Ref. 9366 ▶ 60x60
- Ref. 9377 ▶ 70x70
- Ref. 9388 ▶ 80x80

SOLO	FORMICA COMPACT
247,80€	263,20€
266,00€	285,60€
282,80€	323,40€

75 cm.



MESA SUECIA Columna Médula Antracita, Café o Blanco

- Ref. 9311 ▶ 110x70
- Ref. 9311 ▶ 120x80

SOLO	FORMICA COMPACT
354,20€	407,40€
385,00€	438,20€

110 cm.



MESA SUECIA ALTA Columna Médula Antracita, Café o Blanco

- Ref. 9160 ▶ Ø60
- Ref. 9170 ▶ Ø70
- Ref. 9166 ▶ 60x60
- Ref. 9177 ▶ 70x70

SOLO	FORMICA COMPACT
246,40€	281,40€
257,60€	303,80€
266,00€	281,40€
284,20€	303,80€

 Bastidor de Aluminio para reforzar tablero: 80x80 y 90x90 - 56 €



## MESA SUECIA ALTA 2 TAPAS Aluminio

Ref. 9163 ▶ Ø60  
Ref. 9173 ▶ Ø70

INOX REPULSADO	SOLO	FORMICA COMPACT
235,20€	250,60€	285,60€
	261,80€	308,00€



## MESA SUECIA ALTA 2 TAPAS Aluminio

Ref. 9164 ▶ Ø60  
Ref. 9174 ▶ Ø70

INOX REPULSADO	SOLO	FORMICA COMPACT
246,40€	261,80€	296,80€
	273,00€	319,20€



## MESA SUECIA ALTA Aluminio

Ref. 9165 ▶ Ø60  
Ref. 9165 ▶ Ø70

INOX REPULSADO	SOLO	FORMICA COMPACT
201,60€	217,00€	252,00€
	228,20€	274,40€



## MESA SUECIA ALTA Aluminio

Ref. 9160 ▶ Ø60  
Ref. 9170 ▶ Ø70  
Ref. 9166 ▶ 60x60  
Ref. 9177 ▶ 70x70

INOX REPULSADO	SOLO	FORMICA COMPACT
214,20€	229,60€	264,60€
	240,80€	287,00€
	249,20€	264,60€
	267,40€	287,00€



## MESA SUECIA ALTA Columna Médula Antracita, Café o Blanco

Ref. 9165 ▶ Ø60  
Ref. 9165 ▶ Ø70

INOX REPULSADO	SOLO	FORMICA COMPACT
218,40€	233,80€	268,80€
	245,00€	291,20€



Bastidor de Aluminio para reforzar tablero:  
110x70 y 120x80 - 63 €

Los precios pueden estar desactualizados. Llámanos al 91 161 03 04 para consultar los precios en vigor.

MESA DINAMARCA Aluminio



	SOLO	FORMICA COMPACT
Ref. 9607 ▶ Ø70	169,40€	215,60€
Ref. 9680 ▶ Ø80	177,80€	Consultar Precio
Ref. 9666 ▶ 60x60	177,80€	193,20€
Ref. 9677 ▶ 70x70	196,00€	215,60€
Ref. 9688 ▶ 80x80	212,80€	253,40€

MESA DINAMARCA ABATIBLE Aluminio



	SOLO	FORMICA COMPACT
Ref. 9666AB ▶ 60x60	201,60€	217,00€
Ref. 9677AB ▶ 70x70	219,80€	239,40€
Ref. 9688AB ▶ 80x80	236,60€	277,20€

MESA DINAMARCA Aluminio



	SOLO	FORMICA COMPACT
Ref. 9611 ▶ 100x60	254,80€	
Ref. 9611 ▶ 110x70	284,20€	337,40€
Ref. 9611 ▶ 120x80	315,00€	368,20€

MESA DINAMARCA ABATIBLE Aluminio



	SOLO	FORMICA COMPACT
Ref. 9611AB ▶ 100x60	302,40€	
Ref. 9611AB ▶ 110x70	331,80€	385,00€
Ref. 9611AB ▶ 120x80	362,60€	415,80€

MESA DINAMARCA ALTA Aluminio



	INOX REPULSADO	SOLO	FORMICA COMPACT
Ref. 9060 ▶ Ø60	151,20€	166,60€	201,60€
Ref. 9070 ▶ Ø70		177,80€	224,00€
Ref. 9066 ▶ 60x60		186,20€	201,60€

Las mesas Dinamarca Ref. 9060, 9070 y 9066 pueden llevar la columna en acabado Deco-Bambú sin aumentar su precio.

 Bastidor de Aluminio para reforzar tablero: 80x80 y 90x90 - 56 €

## MESA DINAMARCA ALTA 2 TAPAS Aluminio



Ref. 9106 ▶ Ø60  
Ref. 9107 ▶ Ø70

INOX REPULSADO	SOLO	FORMICA COMPACT
182,00€	197,40€	232,40€
	208,60€	254,80€

## MESA DINAMARCA Columna Médula Antracita, Café o Blanco



Ref. 9607 ▶ Ø70  
Ref. 9680 ▶ Ø80  
Ref. 9666 ▶ 60x60  
Ref. 9677 ▶ 70x70  
Ref. 9688 ▶ 80x80

SOLO	FORMICA COMPACT
180,60€	226,80€
189,00€	Consultar Precio
189,00€	204,40€
207,20€	226,80€
224,00€	264,60€

## MESA DINAMARCA Columna Médula Antracita, Café o Blanco



Ref. 9611 ▶ 100x60  
Ref. 9611 ▶ 110x70  
Ref. 9611 ▶ 120x80

SOLO	FORMICA COMPACT
277,20€	
306,60€	359,80€
337,40€	390,60€

## MESA DINAMARCA ALTA Columna Médula Antracita, Café o Blanco



Ref. 9060 ▶ Ø60  
Ref. 9070 ▶ Ø70  
Ref. 9066 ▶ 60x60

INOX REPULSADO	SOLO	FORMICA COMPACT
168,00€	183,40€	218,40€
	194,60€	240,80€
	203,00€	218,40€

Bastidor de Aluminio para reforzar tablero:  
110x70 y 120x80 - 63 €

Los precios pueden estar desactualizados. Llámanos al 91 161 03 04 para consultar los precios en vigor.

74 cm.



MESA APILABLE VENUS ☑ 30 x 30 x 1,8 mm.  
Aluminio Pintado Gris, Negro, Grafito o Blanco

Ref. 8177 ▶ 70x70

SOLO	 COMPACT
177,80€	197,40€

74 cm.



MESA APILABLE VENUS ☑ 30 x 30 x 1,8 mm.  
Aluminio Pintado Gris, Negro, Grafito o Blanco

Ref. 8177 ▶ 70x70

SOLO	 COMPACT
177,80€	197,40€

74 cm.



MESA APILABLE EUROPA ☉ 30 x 1,8 mm.  
Aluminio Pintado Gris, Negro, Grafito o Blanco

Ref. 8277 ▶ 70x70

SOLO	 COMPACT
166,60€	186,20€

74 cm.



MESA APILABLE EUROPA ☉ 30 x 1,8 mm.  
Aluminio Pintado Gris, Negro, Grafito o Blanco

Ref. 8277 ▶ 70x70

SOLO	 COMPACT
166,60€	186,20€



## MESAS APILABLES Aluminio

70 cm.



Ref. 8060 ▶ Ø60  
Ref. 8070 ▶ Ø70

INOX REPULSADO	SOLO	FORMICA COMPACT
96,60€	112,00€	147,00€
	126,00€	172,20€

## MESAS APILABLES Aluminio

70 cm.



Ref. 8080 ▶ Ø80

SOLO
152,60€

## MESAS APILABLES Aluminio

70 cm.



Ref. 8066 ▶ 60x60  
Ref. 8077 ▶ 70x70

SOLO	FORMICA COMPACT
148,40€	163,80€
170,80€	190,40€

## MESAS DOBLE PATA Aluminio

70 cm.



Ref. 8077DP ▶ 70x70

SOLO	FORMICA COMPACT
183,40€	203,00€

## MESAS DOBLE PATA Pintado Deco-Bambú

70 cm.



Ref. 8077DB ▶ 70x70  
Ref. 8088DB ▶ 80x80

SOLO	FORMICA COMPACT
183,40€	203,00€
203,00€	243,60€

PIE DE MESA ARMAZÓN PATA SENCILLA Y PATA DOBLE Ø 30 mm.

# MESA BAJA TROYA 70x70 NOGAL

REF.<sup>a</sup> 163833

35



**MEDIDAS:** 76 (alt) x 70 (largo) x 70 (ancho) cm.



Estructura de hierro en color negro.

Patas de 40x40 mm.

Tablero de melamina de 2 cm. color nogal.

**HOBETO**  
HOSTELERIA S.L.



**MEDIDAS:** 76 (alt) x 70 (largo) x 70 (ancho) cm.



Estructura de hierro en color negro.

Patas de 40x40 mm.

Tablero de melamina de 2 cm. color roble claro.

# MESA BAJA TROYA 70X70 WENGUÉ

REF.<sup>a</sup> 163830

37



**MEDIDAS:** 76 (alt) x 70 (largo) x 70 (ancho) cm.



Estructura de hierro en color negro.

Patas de 40x40 mm.

Tablero de melamina de 2 cm. color wengué.

**HOBETO**  
HOSTELERIA S.L.

# MESA BAJA TROYA 70X70 NEGRA

REF.ª 163825



**MEDIDAS:** 76 (alt) x 70 (largo) x 70 (ancho) cm.



Estructura de hierro en color gris. Patas de 40x40 mm.  
Tablero de melamina de 2 cm. color negro.

**HOBETO**  
**HOSTELERIA S.L.**

# MESA BAJA MÁRMOL CUADRADA

REF.<sup>a</sup> 161260

39



**MEDIDAS:** 72 (alt) x 60 x 60 cm.



Estructura de hierro forjado y tablero de mármol de 2 cm.

# MESA BAJA MÁRMOL REDONDA

REF.<sup>a</sup> 696384



**MEDIDAS:** 72 (alt) x 60 (diám.) cm.



Estructura de hierro forjado y tablero de mármol de 2 cm.





**MEDIDAS:** 72 (alt) x 60 (ancho) x 100 (largo) cm.



Estructura de hierro forjado y tablero de mármol.

# MESA BAJA TURÍN 70X70

REF.<sup>a</sup> 164690

41



**MEDIDAS:** 75 (alt) x 70 (largo) x 70 (ancho) cm.



Estructura y base en acero inox. Base de 40x40x2,5 cm.  
Tablero de melamina con 2,5 cm de grosor. Tubo de 60x60 mm.



**MEDIDAS:** 76 (alt) x 110 (largo) x 70 (ancho) cm.



Estructura de hierro en color gris.

Tablero de melamina de 2 cm. Patas de 50x50 mm.

# MESA BAJA TROYA XL WENGUÉ

REF.<sup>a</sup> 167392

43



**MEDIDAS:** 76 (alt) x 110 (largo) x 70 (ancho) cm.



Estructura de hierro en color negro.  
Tablero de melamina de 2 cm. Patas de 50x50 mm.

# MESA BAJA TROYA XXL NEGRA

REF.<sup>a</sup> 167390



**MEDIDAS:** 76 (alt) x 120 (largo) x 80 (ancho) cm.



Estructura de hierro en color gris.  
Tablero de melamina de 2 cm. color negro  
Patas de 50x50 mm.

**HOBETO**  
**HOSTELERIA S.L.**

# MESA BAJA VINTAGE SENA MODELO T1

REF.<sup>a</sup> 176554

45



**MEDIDAS:** 74 (alt.) cm. Tablero de 60 (diám.) cm. con 2,5 cm. de grosor.



Mesa de pie central de hierro negro. Acabado en melamina y dibujo diferente en cada mesa.



# MESA BAJA VINTAGE SENA MODELO T2

REF.ª 176555



**MEDIDAS:** 74 (alt.) cm. Tablero de 60 (diám.) cm. con 2,5 cm. de grosor.



Mesa de pie central de hierro negro.  
Acabado en melamina y dibujo diferente en cada mesa.

**HOBETO**  
**HOSTELERIA S.L.**

# MESA BAJA VINTAGE SENA MODELO T3

REF.<sup>a</sup> 176556

47



**MEDIDAS:** 74 (alt.) cm. Tablero de 60 (diám.) cm. con 2,5 cm. de grosor.



Mesa de pie central de hierro negro. Acabado en melamina y dibujo diferente en cada mesa.

# MESA BAJA VINTAGE SENA MODELO T4

REF.ª



**MEDIDAS:** 74 (alt) x 60 (largo) x 60 (ancho) cm.  
Tablero de 2,5 cm de grosor.



Pie central de hierro redondo de 76mm (diam).  
Tablero de acabado en melamina con diseño vintage T4.

**HOBETO**  
**HOSTELERIA S.L.**

# MESA BAJA SENA MODELO B1

REF. <sup>a</sup>

49

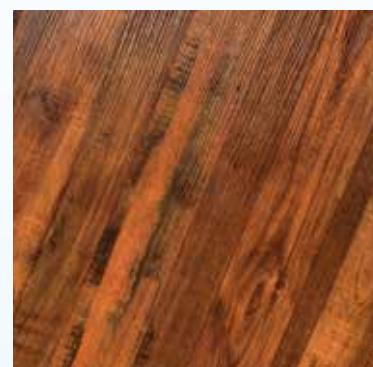

**MEDIDAS:** 74 (alt) x 70 (largo) x 70 (ancho) cm.  
Tablero de 2,5 cm de grosor.



Pie central de hierro redondo de 76mm (diam).  
Tablero de 70 x 70 cm. acabado en melamina con diseño original B1.





**MEDIDAS:** 74 (alt) x 70 (largo) x 70 (ancho) cm.  
Tablero de 2,5 cm de grosor.



Pie central de hierro redondo de 76mm (diam).  
Tablero de 70 x 70 cm. acabado en melamina con diseño original B2.

# MESA BAJA SENA MODELO B3

REF. <sup>a</sup>

51



**MEDIDAS:** 74 (alt) x 70 (largo) x 70 (ancho) cm.  
Tablero de 2,5 cm de grosor.



Pie central de hierro redondo de 76mm (diam).  
Tablero de 70 x 70 cm. acabado en melamina con diseño original B3.

**HOBETO**  
HOSTELERIA S.L.





**MEDIDAS:** 74 (alt) x 70 (largo) x 70 (ancho) cm.  
Tablero de 2,5 cm de grosor.



Pie central de hierro redondo de 76mm (diam).  
Tablero de 70 x 70 cm. acabado en melamina con diseño original B4.

# MESA BAJA ODÍN 120x80

REF.ª

53



**MEDIDAS:** 75 cm (alt). Estructura de hierro en color negro con patas de 20x40x0,8 mm.



Tablero de melamina de 120x80 cm y con un grosor de 30 mm con color madera nórdica.

**HOBETO**  
HOSTELERIA S.L.

Los precios pueden estar desactualizados. Llámamos al 91 161 03 04 para consultar los precios en vigor.



**MEDIDAS:** 75 cm (alt). Estructura de hierro en color negro con patas de 20x40x0,8 mm.



Tablero de melamina de 80x80 cm y con un grosor de 30 mm con color madera nórdica.

# PATA DE HIERRO FORJADO PARA MESA BAJA

REF. <sup>a</sup>

55



Pie de forja decorada y pintada en color negro, para mesas de 74 cm de altura.



Soporte de 24x24 cm para sujeción de tablero.





Sillón M267 negro. Mesa M3504 tablero Werzalit con cargador integrado 70x70 cm. Wave-Alizes



Video Tablero con cargador Integrado



Carga vía USB con 2 puertos



Recarga Inalámbrica

**TABLERO WAVE-ALIZES 70 x70 cm. con cargador integrado para móvil.**

Precio 300 €



Sin toma de corriente eléctrica



Sin instalación



Hasta 8 días de autonomía



Carga vía USB con 2 puertos

## M330

Armazón de aluminio fundido plastificado.\*

Ver acabados en carta de colores.

Características:

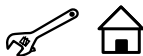

TABLERO MEDIDAS EN CM	MÁRMOL	CHAPADO HAYA CANTO HAYA	WERZALIT SOLO	MELAMINA /ESTRAT. CANTO HAYA
70 x 70	210 €	162 €	165 €	122 €
80 x 80	-	180 €	178 €	129 €
100 x 60	-	174 €	178 €	128 €
105 x 60	237 €	-	-	-
110 x 65	255 €	-	-	-
110 x 70	-	198 €	192 €	135 €

\* Plastificado standard blanco o negro.

Colores especiales **incremento 5 €**

## M332

Armazón de aluminio fundido plastificado.\*

Ver acabados en carta de colores.

Características:



TABLERO MEDIDAS EN CM	MÁRMOL	CHAPADO HAYA CANTO HAYA	WERZALIT SOLO	MELAMINA /ESTRAT. CANTO HAYA
Ø 50	151 €	-	-	-
Ø 60	179 €	162 €	130 €	113 €
Ø 70	206 €	172 €	138 €	118 €

\* Plastificado standard blanco o negro.

Colores especiales **incremento 5 €**

## M348

Armazón de aluminio fundido plastificado.\*

Ver acabados en carta de colores.

Características:



TABLERO MEDIDAS EN CM	MÁRMOL	CHAPADO HAYA CANTO HAYA	WERZALIT SOLO	MELAMINA /ESTRAT. CANTO HAYA
Ø 60	216 €	199 €	167 €	150 €
Ø 70	243 €	209 €	175 €	155 €
Ø 80	-	234 €	181 €	-
60 x 60	213 €	176 €	181 €	146 €
70 x 70	240 €	191 €	194 €	152 €
80 x 80	-	209 €	207 €	158 €

\* Plastificado standard blanco o negro.

Colores especiales **incremento 5 €**



# M361

Armazón de aluminio fundido plastificado.\*

Ver acabados en carta de colores.

Características:



I  
74

TABLERO	MÁRMOL	CHAPADO HAYA CANTO HAYA	WERZALIT SOLO	MELAMINA /ESTRAT. CANTO HAYA
MEDIDAS EN CM				
Ø 60	158 €	141 €	110 €	93 €
Ø 70	186 €	152 €	118 €	98 €
Ø 80	-	176 €	123 €	-

\* Plastificado standard blanco o negro.  
Colores especiales **incremento 14 €**



# M362

Armazón de aluminio fundido plastificado.\*

Ver acabados en carta de colores.

Características:



I  
73

TABLERO	MÁRMOL	CHAPADO HAYA CANTO HAYA	WERZALIT SOLO	MELAMINA /ESTRAT. CANTO HAYA
MEDIDAS EN CM				
Ø 70	198 €	164 €	130 €	110 €
Ø 80	-	188 €	135 €	-
Ø 90	-	-	152 €	-
60 x 60	168 €	131 €	135 €	100 €
70 x 70	194 €	146 €	149 €	106 €
80 x 80	-	164 €	162 €	113 €

\* Plastificado standard blanco o negro.  
Colores especiales **incremento 14 €**



# M363

Armazón de aluminio fundido plastificado.\*

Ver acabados en carta de colores.

Características:



74

TABLERO	CHAPADO HAYA CANTO HAYA	WERZALIT SOLO	MELAMINA /ESTRAT. CANTO HAYA
MEDIDAS			
Ø 90	-	166 €	-
Ø 120	-	248 €	-
80 x 80	178 €	175 €	127 €

\* Plastificado standard blanco o negro.

Colores especiales **incremento 14 €**

# M364

Armazón de aluminio fundido plastificado.\*

Ver acabados en carta de colores.

Características:



73

TABLERO	MÁRMOL	CHAPADO HAYA CANTO HAYA	WERZALIT SOLO	MELAMINA /ESTRAT. CANTO HAYA
MEDIDAS				
100 x 60	-	186 €	189 €	139 €
105 x 60	249 €	-	-	-
110 x 65	267 €	-	-	-
110 x 70	-	209 €	204 €	147 €
120 x 80	-	229 €	227 €	155 €

\* Plastificado standard blanco o negro.

Colores especiales **incremento 14 €**

# M300

Armazón de tubo acerado.\*

Ver acabados en carta de colores.

Características:



I  
74

TABLERO	WERZALIT SOLO	MELAMINA/ESTRATIFICADO CANTO HAYA	CHAPADO HAYA CANTO HAYA
MEDIDAS EN CM	PLASTIFICADO STANDARD*		
Ø 60	79 €	62 €	111 €
Ø 70	87 €	67 €	121 €
Ø 80	93 €	-	146 €
Ø 90	110 €	-	-
60 x 60	93 €	58 €	88 €
70 x 70	106 €	64 €	103 €
ACABADO CROMADO INCREMENTO 17 €			

\* Plástico standard blanco o negro.

Colores especiales **incremento 5 €**



# M301

Armazón de tubo acerado.\*

Ver acabados en carta de colores.

Características:



I  
74

TABLERO	WERZALIT SOLO	MELAMINA/ESTRATIFICADO CANTO HAYA	CHAPADO HAYA CANTO HAYA
MEDIDAS EN CM	PLASTIFICADO STANDARD*		
100 x 60	127 €	77 €	123 €
110 x 70	141 €	84 €	147 €
120 x 80	165 €	93 €	167 €
ACABADO CROMADO INCREMENTO 22 €			

\* Plástico standard blanco o negro.

Colores especiales **incremento 5 €**



Cromado "solo" laterales

# M309

Armazón de tubo oval acerado.\*

Ver acabados en carta de colores.

Características:



T  
74

TABLERO	WERZALIT SOLO	MELAMINA/ESTRATIFICADO CANTO HAYA	CHAPADO HAYA CANTO HAYA
MEDIDAS EN CM	PLASTIFICADO STANDARD*		
Ø 80	114 €	-	167 €
Ø 90	131 €	-	-
70 x 70	128 €	85 €	125 €
80 x 80	140 €	92 €	143 €
ACABADO CROMADO INCREMENTO 22 €			

\* Plástico standard blanco o negro.

Colores especiales **incremento 5 €**



# M310

Armazón de tubo oval acerado.\*

Ver acabados en carta de colores.

Características:



T  
74

TABLERO	WERZALIT SOLO	MELAMINA/ESTRATIFICADO CANTO HAYA	CHAPADO HAYA CANTO HAYA
MEDIDAS EN CM	PLASTIFICADO STANDARD*		
110 x 70	173 €	116 €	179 €
120 x 80	197 €	124 €	199 €
ACABADO CROMADO INCREMENTO 22 €			

\* Plástico standard blanco o negro.

Colores especiales **incremento 5 €**



Cromado "solo" laterales

# M304

Armazón de tubo acerado.\*

Ver acabados en carta de colores.

Características:



Cromado



Plastificado Aluminio

TABLERO	WERZALIT SOLO	MELAMINA/ ESTRATIFICADO CANTO HAYA	CHAPADO HAYA CANTO HAYA
MEDIDAS EN CM	PLASTIFICADO STANDARD*		
Ø 80	123 €	-	176 €
Ø 90	140 €	-	-
Ø 120	223 €	-	-
60 x 60	123 €	88 €	119 €
70 x 70	137 €	95 €	134 €
80 x 80	150 €	101 €	152 €
100 x 60	150 €	100 €	147 €
110 x 70	165 €	108 €	170 €
120 x 80	188 €	116 €	190 €

ACABADO CROMADO INCREMENTO 47 €

\* Plastificado standard blanco o negro.

Colores especiales **incremento 5 €**

# M306

Armazón de tubo acerado.\*

Ver acabados en carta de colores.

Características:



TABLERO	WERZALIT SOLO	MELAMINA / ESTRAT. CANTO HAYA	CHAPADO HAYA/ CANTO HAYA
MEDIDAS EN CM	PLASTIFICADO STANDARD*		
Ø 80	109 €	-	162 €
Ø 90	126 €	-	-
Ø 120	208 €	-	-
60 x 60	109 €	74 €	104 €
70 x 70	122 €	80 €	119 €
80 x 80	135 €	86 €	137 €
100 x 60	135 €	85 €	132 €
110 x 70	150 €	93 €	155 €
120 x 80	173 €	101 €	175 €

ACABADO CROMADO INCREMENTO 40 €

\* Plastificado standard blanco o negro.

Colores especiales **incremento 5 €**

# M318

Armazón de tubo oval acerado.\*

Ver acabados en carta de colores.

Características:

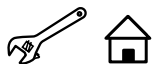

TABLERO	WERZALIT SOLO	MELAMINA /ES-TRAT. CANTO HAYA	CHAPADO HAYA CANTO HAYA
MEDIDAS EN CM	PLASTIFICADO STANDARD*		
Ø 60	75 €	58 €	106 €
Ø 70	83 €	63 €	117 €

ACABADO CROMADO INCREMENTO 31 €

\* Plastificado standard blanco o negro.

Colores especiales **incremento 5 €**

# M319

Armazón de tubo oval acerado.\*

Ver acabados en carta de colores.

Características:

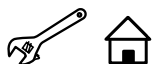

TABLERO	WERZALIT SOLO	MELAMINA /ESTRATIFICADO CANTO HAYA	CHAPADO HAYA CANTO HAYA
MEDIDAS EN CM	PLASTIFICADO STANDARD*		
Ø 70	93 €	72 €	127 €
Ø 80	98 €	-	151 €
Ø 90	115 €	-	-
Ø 120	198 €	-	-
60 x 60	98 €	63 €	93 €
70 x 70	112 €	69 €	109 €
80 x 80	124 €	76 €	127 €

ACABADO CROMADO INCREMENTO 28 €

\* Plastificado standard blanco o negro.

Colores especiales **incremento 5 €**

# M320

Armazón de tubo oval acerado.\*

Cromado "sólo" laterales

Ver acabados en carta de colores.

Características:

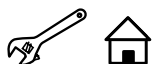

Plastificado Titanio



Plastificado Negro



TABLERO	WERZALIT SOLO	CHAPADO HAYA CANTO HAYA	MELAMINA / ESTRAT. CANTO HAYA
MEDIDAS EN CM	PLASTIFICADO STANDARD*		
100 x 60	132 €	129 €	82 €
110 x 70	147 €	152 €	90 €
120 x 80	170 €	172 €	98 €

ACABADO CROMADO INCREMENTO 17 €

\* Plastificado standard blanco o negro.

Colores especiales **incremento 5 €**

# M359

Armazón de tubo acerado.\*

Ver acabados en carta de colores.

Características:



72

Tablero Werzalit Blanco



Tablero Sevelit Pino viejo

TABLERO	WERZALIT SOLO	MELAMINA / ESTRATIFICADO CANTO HAYA	SEVELIT
MEDIDAS EN CM			
70 x 70	140 €	98 €	121 €
110 x 70	168 €	111 €	-
115 x 70	-	-	134 €

\* Plástico standard blanco o negro.

Colores especiales **incremento 5 €**

# M435

Armazón de aluminio plastificado.  
Colores Aluminio y Oxidón.

Ver acabados en carta de colores.

Características:



74

Plastificado Aluminio



Plastificado Oxidón

TABLERO	WERZALIT SOLO	CHAPADO HAYA CANTO HAYA	COMPACT BASIC	COMPACT PREMIUM	MELAMINA / ESTRAT. CANTO HAYA	SEVELIT
MEDIDAS EN CM						
Ø 60	87 €	119 €	116 €	123 €	70 €	76 €
Ø 70	96 €	130 €	130 €	140 €	76 €	80 €



# M436

Armazón de aluminio plastificado.  
Colores Aluminio y Oxidón.

Ver acabados en carta de colores.

Características:



Plastificado Aluminio



Plastificado Oxidón



74

TABLERO	WERZALIT SOLO	CHAPADO HAYA CANTO HAYA	COMPACT BASIC	COMPACT PREMIUM	MELAMINA / ESTRAT. CANTO HAYA	SEVELIT
MEDIDAS EN CM						
Ø 70	105 €	139 €	139 €	150 €	85 €	90 €
Ø 80	111 €	164 €	166 €	179 €	-	-
Ø 90	128 €	-	196 €	215 €	-	-
60 x 60	111 €	106 €	126 €	133 €	76 €	-
70 x 70	124 €	121 €	140 €	150 €	82 €	105 €
80 x 80	137 €	139 €	166 €	179 €	88 €	117 €

# M437

Armazón de aluminio plastificado.  
Colores Aluminio y Oxidón.

Ver acabados en carta de colores.

Características:



Plastificado Aluminio



Plastificado Oxidón



73

TABLERO	WERZALIT SOLO	CHAPADO HAYA CANTO HAYA	COMPACT BASIC	COMPACT PREMIUM	MELAMINA / ESTRAT. CANTO HAYA	SEVELIT
MEDIDAS EN CM						
110 X 70	175 €	181 €	211 €	224 €	118 €	-
115 X 70	-	-	-	-	-	141 €
120 X 80	199 €	201 €	224 €	236 €	127 €	-

# M353

Armazón con base de aluminio fundido plastificado y tubo acerado.

Ver acabados en carta de colores.

Características:



A-9400 Accesorio Colgador bolsos

Precio Colgador 13 €



TABLERO	WERZALIT SOLO	COMPACT BASIC	COMPACT PREMIUM	CHAPADO HAYA CANTO HAYA	MELAMINA /ESTRAT. CANTO HAYA
MEDIDAS EN CM	PLASTIFICADO		STANDARD*		
Ø 60	114 €	143 €	150 €	146 €	97 €
Ø 70	122 €	156 €	167 €	156 €	102 €
60 x 60	128 €	143 €	150 €	123 €	93 €

\* Plastificado standard blanco o negro. Colores especiales **incremento 5 €**

# M354

Armazón con base de aluminio fundido plastificado y tubo acerado.

Ver acabados en carta de colores.

Características:



A-9400 Accesorio Colgador bolsos

Precio Colgador 13 €



TABLERO	WERZALIT SOLO	COMPACT BASIC	COMPACT PREMIUM	CHAPADO HAYA CANTO HAYA	MELAMINA /ESTRAT. CANTO HAYA
MEDIDAS EN CM	PLASTIFICADO		STANDARD*		
Ø 70	137 €	171 €	182 €	171 €	117 €
Ø 80	143 €	198 €	210 €	196 €	-
Ø 90	159 €	227 €	246 €	-	-
60x60	143 €	157 €	165 €	138 €	108 €
70x70	156 €	172 €	182 €	153 €	114 €
80x80	169 €	198 €	210 €	171 €	120 €

\* Plastificado standard blanco o negro. Colores especiales **incremento 5 €**

# M355

Armazón con base de aluminio fundido plastificado y tubo acerado.

Ver acabados en carta de colores.

Características:



TABLERO	WERZALIT SOLO	COMPACT BASIC	COMPACT PREMIUM	CHAPADO HAYA CANTO HAYA	MELAMINA /ESTRAT. CANTO HAYA
MEDIDAS EN CM	PLASTIFICADO		STANDARD*		
110 x 70	210 €	246 €	259 €	216 €	153 €
120 x 80	234 €	259 €	271 €	236 €	162 €

\* Plastificado standard blanco o negro. Colores especiales **incremento 5 €**

# M387

Armazón con base de aluminio fundido plastificado y tubo acerado.

Ver acabados en carta de colores.

Características:



T  
74

TABLERO	WERZALIT SOLO	COMPACT BASIC	COMPACT PREMIUM
MEDIDAS EN CM	PLASTIFICADO STANDARD*		
Ø 90	223 €	291 €	310 €
Ø 120	306 €	-	-

\* Plastificado standard blanco o negro.  
Colores especiales **incremento 5 €**



# M3008

Armazón de tubo acerado.\*

Ver acabados en carta de colores.

Características:



□  
74

TABLERO	WERZALIT SOLO	TABLON PINO MACIZO CANTO IRREGULAR	CHAPADO HAYA CANTO HAYA	MELAMINA / ESTRAT. CANTO HAYA
MEDIDAS EN CM	PLASTIFICADO		STANDARD*	
70 X 70	135 €	207 €	132 €	93 €
80 X 80	148 €	217 €	150 €	99 €
110 x 70	163 €	237 €	168 €	105 €
120 x 80	186 €	260 €	188 €	114 €

\* Plastificado standard blanco o negro.  
Colores especiales **incremento 5 €**



Silla M1008 negro transparente, asiento madera nogal.  
Mesa M3008 negro transparente, tablón pino macizo irregular 80x80 cm. nogal

# M369

Armazón con base de hierro fundido.  
Tubo acerado

Ver acabados en carta de colores.

Características:



I  
74

TABLERO	WERZALIT SOLO	COMPACT BASIC	COMPACT PREMIUM	CHAPADO HAYA CANTO HAYA	MELAMINA /ESTRAT. CANTO HAYA
MEDIDAS EN CM	PLASTIFICADO STANDARD*				
Ø 120	253 €	-	-	-	-
100x60	180 €	216 €	232 €	176 €	130 €
110x70	194 €	231 €	243 €	200 €	137 €
120x80	218 €	243 €	255 €	220 €	146 €

ACABADO CROMADO INCREMENTO 25 €

\* Plastificado standard blanco o negro.  
Colores especiales **incremento 5 €**



Cromado "solo" tubo

# M3031

Armazón con base de hierro fundido.  
Tubo acerado

Ver acabados en carta de colores.

Características:



I  
74

TABLERO	WERZALIT SOLO	COMPACT BASIC	COMPACT PREMIUM	CHAPADO HAYA CANTO HAYA	MELAMINA / ESTRAT. CANTO HAYA
MEDIDAS EN CM					
100 x 60	184 €	220 €	236 €	181 €	134 €
110 x 70	199 €	235 €	247 €	204 €	141 €
120 x 80	222 €	247 €	259 €	224 €	150 €

\* Plastificado standard blanco o negro.  
Colores especiales **incremento 5 €**



# M3032

Armazón con base de hierro fundido.  
Tubo acerado

Ver acabados en carta de colores.

Características:



I  
74

TABLERO	WERZALIT SOLO	COMPACT BASIC	COMPACT PREMIUM	CHAPADO HAYA CANTO HAYA	MELAMINA / ESTRAT. CANTO HAYA
MEDIDAS EN CM					
Ø 60	113 €	141 €	149 €	145 €	96 €
Ø 70	121 €	155 €	166 €	155 €	101 €
Ø 80	127 €	182 €	194 €	180 €	-



\* Plastificado standard blanco o negro.  
Colores especiales **incremento 5 €**



# M368

Armazón con base de hierro fundido.  
Tubo acerado

Ver acabados en carta de colores.

Características:   

I  
73

TABLERO	WERZALIT SOLO	COMPACT BASIC	COMPACT PREMIUM	CHAPADO HAYA CANTO HAYA	MELAMINA /ESTRAT. CANTO HAYA
MEDIDAS EN CM	PLASTIFICADO		STANDARD*		
Ø 60	114 €	143 €	150 €	146 €	97 €
Ø 70	122 €	156 €	167 €	156 €	102 €
Ø 80	128 €	183 €	196 €	181 €	-
Ø 90	145 €	212 €	232 €	-	-
60x60	128 €	143 €	150 €	123 €	93 €
70x70	141 €	157 €	167 €	138 €	99 €
80x80	154 €	183 €	196 €	156 €	105 €
100x60	154 €	190 €	206 €	151 €	104 €

ACABADO CROMADO INCREMENTO 27 €

\* Plastificado standard blanco o negro.  
Colores especiales **incremento 5 €**





Cromado "solo" tubo

Plastificado Titanio

# M370

Armazón con base de hierro fundido.  
Tubo acerado

Ver acabados en carta de colores.

Características:   

I  
73

TABLERO	WERZALIT SOLO	COMPACT BASIC	COMPACT PREMIUM	CHAPADO HAYA CANTO HAYA	MELAMINA /ESTRAT. CANTO HAYA
MEDIDAS EN CM	PLASTIFICADO		STANDARD*		
Ø 60	108 €	136 €	144 €	139 €	91 €
Ø 70	116 €	150 €	161 €	150 €	96 €
Ø 80	121 €	176 €	189 €	174 €	-
60x60	121 €	136 €	144 €	117 €	86 €
70x70	135 €	151 €	161 €	132 €	93 €

ACABADO CROMADO INCREMENTO 20 €

\* Plastificado standard blanco o negro.  
Colores especiales **incremento 5 €**





Cromado "solo" tubo

# M3027

Armazón con base de plancha de hierro.  
Tubo acerado

Ver acabados en carta de colores.

Características:   

I  
73

TABLERO MEDIDAS EN CM	WERZALIT SOLO	COMPACT BASIC	COMPACT PREMIUM	CHAPADO HAYA CANTO HAYA	MELAMINA / ESTRAT. CANTO HAYA
Ø 60	117 €	146 €	153 €	149 €	100 €
Ø 70	126 €	159 €	170 €	159 €	105 €



\* Plástico standard blanco o negro.  
Colores especiales **incremento 5 €**



# M3030

Armazón con base de hierro fundido.  
Tubo acerado.

Ver acabados en carta de colores.

Características:   

I  
74

TABLERO MEDIDAS EN CM	WERZALIT SOLO	COMPACT BASIC	COMPACT PREMIUM	CHAPADO HAYA CANTO HAYA	MELAMINA / ESTRAT. CANTO HAYA
Ø 60	116 €	145 €	152 €	148 €	99 €
Ø 70	125 €	158 €	169 €	158 €	104 €
Ø 80	130 €	185 €	198 €	183 €	-
60 x 60	130 €	145 €	152 €	126 €	95 €
70 x 70	144 €	159 €	169 €	140 €	101 €
80 x 80	156 €	185 €	198 €	158 €	108 €

\* Plástico standard blanco o negro.  
Colores especiales **incremento 5 €**



# M3020

Armazón con base de plancha de hierro.  
Tubo acerado

Ver acabados en carta de colores.

Características:



Plastificado Negro

TABLERO MEDIDAS EN CM	WERZALIT SOLO	COMPACT BASIC	COMPACT PREMIUM	CHAPADO HAYA CANTO HAYA	MELAMINA / ESTRAT. CANTO HAYA
Ø 60	115 €	144 €	151 €	147 €	98 €
Ø 70	123 €	157 €	168 €	157 €	103 €
Ø 80	129 €	184 €	197 €	182 €	-
60 x 60	129 €	144 €	151 €	125 €	94 €
70 x 70	143 €	158 €	168 €	139 €	100 €
80 x 80	155 €	184 €	197 €	157 €	106 €

\* Plastificado standard blanco o negro.

Colores especiales **incremento 5 €**

\* Otras medidas, consultar precio y plazo de entrega



Plastificado Aluminio



Oxidón



Amarillo



Azul



Blanco



Celeste



Cobre



Mostaza



Marrón



Negro transparente



Rojo



Turquesa



Titanio





Verde



# M315

Armazón de tubo acerado. Base cromada.

Ver acabados en carta de colores.

Características:   

I  
75



TABLERO	WERZALIT SOLO	COMPACT BASIC	COMPACT PREMIUM	CHAPADO HAYA CANTO HAYA	MELAMINA / ESTRAT. CANTO HAYA
MEDIDAS EN CM					
Ø 60	144 €	172 €	180 €	175 €	127 €
Ø 70	152 €	186 €	197 €	186 €	132 €
Ø 80	157 €	212 €	225 €	210 €	-
60 x 60	157 €	172 €	180 €	153 €	122 €
70 x 70	171 €	187 €	197 €	168 €	129 €











# M322

Armazón con base de acero inoxidable. Tubo de aluminio anodizado.

Ver acabados en carta de colores.

Características:  

I  
74



TABLERO	WERZALIT SOLO	COMPACT BASIC	COMPACT PREMIUM	CHAPADO HAYA CANTO HAYA	MELAMINA / ESTRAT. CANTO HAYA
MEDIDAS EN CM	 	 	 		
Ø 60	152 €	181 €	188 €	184 €	135 €
Ø 70	161 €	194 €	205 €	194 €	140 €
Ø 80	166 €	221 €	234 €	219 €	-
60 x 60	166 €	181 €	188 €	162 €	131 €
70 x 70	180 €	196 €	205 €	176 €	137 €











# M323

Armazón con base de acero inoxidable. Tubo aluminio anodizado.

Ver acabados en carta de colores.

Características:  

I  
74

TABLERO	WERZALIT SOLO	COMPACT BASIC	COMPACT PREMIUM	CHAPADO HAYA CANTO HAYA	MELAMINA / ESTRAT. CANTO HAYA
MEDIDAS EN CM	 	 	 		
Ø 60	153 €	182 €	189 €	185 €	136 €
Ø 70	162 €	196 €	206 €	196 €	141 €
Ø 80	167 €	222 €	235 €	220 €	-
Ø 90	184 €	252 €	271 €	-	-
60 x 60	167 €	182 €	189 €	163 €	132 €
70 x 70	181 €	197 €	206 €	177 €	138 €
80 x 80	193 €	222 €	235 €	196 €	145 €
100 x 60	193 €	229 €	245 €	190 €	144 €



# M324





Armazón con base de acero inoxidable.  
Tubo de aluminio anodizado.

Ver acabados en carta de colores.

Características: 



74

TABLERO	WERZALIT SOLO	COMPACT BASIC	COMPACT PREMIUM	CHAPADO HAYA CANTO HAYA	MELAMINA / ESTRAT. CANTO HAYA
MEDIDAS EN CM					
Ø 120	346 €	-	-	-	-
100 x 60	273 €	309 €	325 €	270 €	223 €
110 x 70	288 €	324 €	337 €	293 €	231 €
120 x 80	311 €	337 €	348 €	313 €	239 €

# M442

Armazón con base de acero inoxidable.  
Columna de madera de haya barnizada.

Ver acabados en carta de colores.

Características: 





74

TABLERO	WERZALIT SOLO	CHAPADO HAYA CANTO HAYA
MEDIDAS EN CM		
Ø 60	192 €	224 €
Ø 70	201 €	235 €
Ø 80	206 €	259 €
60 x 60	206 €	202 €
70 x 70	220 €	217 €

## M3023

Armazón con base de plancha de hierro.  
Tubo acerado

Ver acabados en carta de colores.

Características:   

T  
73

TABLERO MEDIDAS EN CM	WERZALIT SOLO	COMPACT BASIC	COMPACT PREMIUM	CHAPADO HAYA CANTO HAYA	MELAMINA / ESTRAT. CANTO HAYA
100 x 60	171 €	207 €	223 €	168 €	121 €



\* Plástico standard blanco o negro.  
Colores especiales **incremento 5 €**



## M3024

Armazón con base de plancha de hierro.  
Tubo acerado

Ver acabados en carta de colores.

Características:   

T  
73

TABLERO MEDIDAS EN CM	WERZALIT SOLO	COMPACT BASIC	COMPACT PREMIUM	CHAPADO HAYA CANTO HAYA	MELAMINA / ESTRAT. CANTO HAYA
110 x 70	215 €	251 €	263 €	220 €	157 €
120 x 80	238 €	263 €	275 €	240 €	166 €



\* Plástico standard blanco o negro.  
Colores especiales **incremento 5 €**



## M3040

Armazón: Aluminio fundido plastificado\*.

Ver acabados en carta de colores.

Características:  

T  
74

TABLERO MEDIDAS EN CM	WERZALIT SOLO	CHAPADO HAYA CANTO HAYA	MELAMINA /ESTRATIFICADO CANTO HAYA
Ø 60	144 €	175 €	127 €
Ø 70	152 €	186 €	132 €
Ø 80	157 €	210 €	-
60 x 60	157 €	153 €	122 €
70 x 70	171 €	168 €	129 €
80 x 80	184 €	186 €	135 €

\* Plástico standard blanco o negro.  
Colores especiales **incremento 5 €**



# M3200

Armazón de tubo de aluminio plastificado.

Colores: Aluminio y antracita.

Ver acabados en carta de colores.

Características:





TABLERO MEDIDAS EN CM	WERZALIT SOLO	MADERA TEKA	COMPACT BASIC	COMPACT PREMIUM	SEVELIT
70 x 70	171 €	186 €	187 €	197 €	152 €
80 x 80	194 €	218 €	223 €	236 €	174 €
110 x 70	228 €	-	264 €	277 €	-
120 x 80	264 €	313 €	290 €	302 €	-



# M311

Armazón: Tubo acerado.  
Plastificado.  
Tablero: Polietileno inyectado.  
Color: Gris.

Características:  





MEDIDAS EN CM	PRECIO
Ø 80 ALTA	81 €
Ø 80	69 €
Ø 116	71 €
Ø 160	192 €
Ø 180	228 €
88 x 88	65 €
160 x 45	65 €
153 x 72	73 €
182 x 74	90 €
200 x 90	132 €
210 x 76	115 €
210 x 86	131 €
240 x 76	134 €
240 x 86	149 €



# M311PLUS

Armazón: Tubo acerado.  
Tablero: Plegable. Polietileno inyectado.  
Color: Gris.

Características:  





MEDIDAS EN CM	PRECIO
182x74	86 €
210x86	126 €
Ø 150	139 €



# M312

Armazón de tubo acerado.

Tablero : Melamínico color crema. Canteado en PVC.

Características:  



74

PRECIOS		
MEDIDAS EN CM	PLASTIFICADO STANDARD*	CROMADO
Ø 150	153 €	215 €
Ø 160	158 €	220 €
Ø 180	181 €	243 €
200 x 45	134 €	196 €
200 x 80	149 €	211 €
240 x 80	175 €	237 €

\* Plástico standard blanco o negro.

Colores especiales **incremento 5 €**



# M950

CARRO PARA TRANSPORTAR MESAS PLEGABLES REDONDAS.

Capacidad de transporte: 9 unidades de mesas.

Es una herramienta de trabajo.

Su diseño puede variar.

Características: 

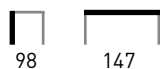

Precio 264 €

# M951

CARRO PARA TRANSPORTAR MESAS PLEGABLES RECTANGULARES.

Es una herramienta de trabajo.

Su diseño puede variar.

Características: 



Precio 261 €





Silla M195. Mesa M440 tablero compact 70x70 cm. blanco.

## M413

Armazón: Tubo de aluminio. Plastificado en color aluminio.\*

Ver acabados en carta de colores.

Características:



75



Oxidón



Aluminio

TABLERO	CHAPADO HAYA CANTO HAYA	COMPACT BASIC	COMPACT PREMIUM
MEDIDAS EN CM			
70 x 70	177 €	197 €	206 €
80 x 80	206 €	233 €	245 €
110 x 70	230 €	264 €	274 €
120 x 80	257 €	280 €	292 €

\* Plastificado color aluminio.

Resto colores **incremento 14 €**

# M440

Armazón de tubo aluminio anodizado. Acabado en inox.  
 Tablero: Compact.  
 Colores: Según carta.

Características: 



  
75

TABLERO MEDIDAS EN CM	COMPACT BASIC	COMPACT PREMIUM
70 x 70	191 €	201 €
80 x 80	225 €	238 €
90 x 90	279 €	286 €
110 x 70	261 €	274 €
120 x 80	282 €	294 €

# M446

Armazón con base aluminio fundido pulido sin anodizar.  
 Con sistema abatible. Tubo aluminio anodizado.

Ver acabados en carta de colores.

Características:  Abatible y encajable



  
73

Abatible y encajable



TABLERO MEDIDAS EN CM	WERZALIT SOLO	ACERO INOXIDABLE REPULSADO	MADERA TEKA	COMPACT BASIC	COMPACT PREMIUM	SEVELIT
Ø 70	173 €	169 €	201 €	207 €	218 €	157 €
Ø 80	179 €	178 €	220 €	234 €	246 €	-
60 x 60	179 €	155 €	186 €	193 €	201 €	-
70 x 70	192 €	170 €	207 €	208 €	218 €	173 €
80 x 80	205 €	181 €	228 €	234 €	246 €	185 €

# M3524

Armazón con base y tubo de aluminio anodizado.  
Con sistema abatible.

Ver acabados en carta de colores.

Características:     Abatible y encajable

  
73



Sistema abatible



TABLERO MEDIDAS EN CM	WERZALIT SOLO	ACERO INOXIDABLE REPULSADO	MADERA TEKA	COMPACT BASIC	COMPACT PREMIUM	SEVELIT
Ø 70	148 €	144 €	175 €	182 €	192 €	132 €
Ø 80	153 €	152 €	194 €	208 €	221 €	-
60 x 60	153 €	130 €	161 €	168 €	175 €	-
70 x 70	167 €	145 €	182 €	183 €	192 €	148 €
80 x 80	180 €	155 €	203 €	208 €	221 €	159 €

# M3525

Armazón con base y tubo de aluminio anodizado.

Ver acabados en carta de colores.

Características:    

  
73



TABLERO MEDIDAS EN CM	WERZALIT SOLO	SEVELIT	MADERA TEKA	COMPACT BASIC	COMPACT PREMIUM
110 x 70	240 €	-	-	276 €	289 €
115 x 70	-	206 €	-	-	-
120 x 80	263 €	-	312 €	289 €	300 €

# M400

Armazón con base de aluminio fundido plastificado.  
Tubo de aluminio anodizado.

Ver acabados en carta de colores.

Características:    

I  
74



Sistema abatible  
PRECIO 33 €



A-9400 Accesorio Colgador bolsos

Precio Colgador 13 €



TABLERO MEDIDAS EN CM	WERZALIT SOLO	ACERO INOXIDABLE REPULSADO	MADERA TEKA	COMPACT BASIC	COMPACT PREMIUM	SEVELIT
Ø 60	106 €	95 €	126 €	135 €	143 €	95 €
Ø 70	115 €	111 €	143 €	149 €	159 €	99 €
60 x 60	120 €	97 €	128 €	135 €	143 €	-

# M401

Armazón con base de aluminio fundido plastificado.  
Tubo de aluminio anodizado.

Ver acabados en carta de colores.

Características:    

I  
74



Sistema abatible  
PRECIO 33 €



A-9400 Accesorio Colgador bolsos

Precio Colgador 13 €



TABLERO MEDIDAS EN CM	WERZALIT SOLO	ACERO INOXIDABLE REPULSADO	MADERA TEKA	COMPACT BASIC	COMPACT PREMIUM	SEVELIT
Ø 70	129 €	124 €	156 €	163 €	173 €	113 €
Ø 80	134 €	133 €	175 €	189 €	202 €	-
60 x 60	134 €	111 €	141 €	149 €	156 €	-
70 x 70	148 €	126 €	163 €	164 €	173 €	129 €
80 x 80	161 €	136 €	184 €	189 €	202 €	140 €

# M402

Armazón con base de aluminio fundido plastificado.  
Tubo de aluminio anodizado.

Ver acabados en carta de colores.

Características:

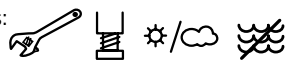

74



A-9400 Accesorio Colgador bolsos

Precio Colgador 13 €



TABLERO MEDIDAS EN CM	WERZALIT SOLO	MADERA TEKA	COMPACT BASIC	COMPACT PREMIUM	SEVELIT
110 x 70	191 €	-	227 €	240 €	-
115 x 70	-	-	-	-	157 €
120 x 80	215 €	263 €	240 €	252 €	-

# M388

Armazón con base de aluminio fundido plastificado.  
Tubo de aluminio anodizado.

Ver acabados en carta de colores.

Características:



75



TABLERO MEDIDAS EN CM	WERZALIT SOLO	COMPACT BASIC	COMPACT PREMIUM
Ø 90	218 €	286 €	305 €
Ø 120	300 €	-	-



# M383

Armazón con base de hierro fundido revestido de acero inoxidable. Tubo de aluminio anodizado.

Ver acabados en carta de colores.

Características:    



A-9400 Accesorio Colgador bolsos

Precio Colgador 13 €

73

TABLERO MEDIDAS EN CM	WERZALIT SOLO	ACERO INOXIDABLE REPULSADO	MADERA TEKA	COMPACT BASIC	COMPACT PREMIUM	SEVELIT
Ø 60	102 €	91 €	121 €	131 €	138 €	91 €
Ø 70	111 €	106 €	138 €	145 €	155 €	95 €
60 x 60	116 €	93 €	123 €	131 €	138 €	-



Sistema abatible  
PRECIO 33 €



# M384

Armazón con base de hierro fundido revestido de acero inoxidable. Tubo de aluminio anodizado.

Ver acabados en carta de colores.

Características:    



A-9400 Accesorio Colgador bolsos

Precio Colgador 13 €

73

TABLERO MEDIDAS EN CM	WERZALIT SOLO	ACERO INOXIDABLE REPULSADO	MADERA TEKA	COMPACT BASIC	COMPACT PREMIUM	SEVELIT
Ø 70	115 €	111 €	143 €	149 €	159 €	99 €
Ø 80	120 €	119 €	162 €	175 €	188 €	-
60 x 60	120 €	97 €	128 €	135 €	143 €	-
70 x 70	134 €	112 €	149 €	150 €	159 €	115 €
80 x 80	147 €	122 €	170 €	175 €	188 €	127 €



Sistema abatible  
PRECIO 33 €



# M385

Armazón con base de hierro fundido revestido de acero inoxidable. Tubo de aluminio anodizado.

Ver acabados en carta de colores.

Características:    

74

TABLERO MEDIDAS EN CM	WERZALIT SOLO	MADERA TEKA	COMPACT BASIC	COMPACT PREMIUM	SEVELIT
110 x 70	186 €	-	222 €	235 €	-
115 x 70	-	-	-	-	152 €
120 x 80	209 €	258 €	235 €	246 €	-



A-9400 Accesorio Colgador bolsos

Precio Colgador 13 €





# M382

Armazón de aluminio anodizado.

Ver acabados en carta de colores.

Características:  (sólo 120 x 80 cm.)

75

TABLERO MEDIDAS EN CM	WERZALIT SOLO	ACERO INOXIDABLE REPULSADO	MADERA TEKA	COMPACT BASIC	COMPACT PREMIUM	SEVELIT
60 x 60	116 €	93 €	123 €	131 €	138 €	-
70 x 70	133 €	111 €	148 €	149 €	158 €	114 €
80 x 80	147 €	122 €	170 €	175 €	188 €	127 €
120 x 80	193 €	-	242 €	219 €	231 €	-



Sillón M2150 (antracita, azul, blanco y rojo). Mesa M382 PL (azul, blanco, negro transparente y rojo) tablero Sevelit 70x70 cm. pino viejo.

# M382PL

Armazón de aluminio plastificado\*.

Ver acabados en carta de colores.

Características:  (sólo 120 x 80 cm.)

75



Azul



Blanco



Rojo



Negro Transparente

TABLERO MEDIDAS EN CM	WERZALIT SOLO	ACERO INOXIDABLE REPULSADO	MADERA TEKA	COMPACT BASIC	COMPACT PREMIUM	SEVELIT
60 x 60	108 €	84 €	115 €	122 €	130 €	-
70 x 70	124 €	102 €	139 €	140 €	150 €	105 €
80 x 80	138 €	114 €	162 €	167 €	180 €	118 €
120 x 80	185 €	-	234 €	210 €	222 €	-

\* Plastificado standard blanco o negro.

Colores especiales **incremento 5 €**

# M329

Armazón de aluminio anodizado.

Ver acabados en carta de colores.

Características:



75

TABLERO MEDIDAS EN CM	WERZALIT SOLO	ACERO INOXIDABLE REPULSADO	COMPACT BASIC	COMPACT PREMIUM	SEVELIT
Ø 80	97 €	96 €	152 €	165 €	-
60 x 60	97 €	74 €	112 €	119 €	-
70 x 70	119 €	97 €	135 €	145 €	100 €

# M380

Armazón de aluminio anodizado.

Ver acabados en carta de colores.

Características:



75

TABLERO MEDIDAS EN CM	WERZALIT SOLO	ACERO INOXIDABLE REPULSADO	COMPACT BASIC	COMPACT PREMIUM	SEVELIT
Ø 60	77 €	65 €	105 €	113 €	65 €
Ø 70	86 €	82 €	120 €	131 €	70 €

# M381

Armazón de aluminio anodizado.

Ver acabados en carta de colores.

Características:



75

TABLERO MEDIDAS EN CM	WERZALIT SOLO	ACERO INOXIDABLE REPULSADO	MADERA TEKA	COMPACT BASIC	COMPACT PREMIUM	SEVELIT
Ø 60	85 €	74 €	104 €	114 €	121 €	74 €
Ø 70	95 €	91 €	122 €	129 €	139 €	79 €
Ø 80	101 €	100 €	143 €	156 €	169 €	-

# M3045

Armazón de aluminio fundido plastificado\*.

Ver acabados en carta de colores.

Características:    Abatible y encajable

□  
75



Amarillo



Verde



Turquesa

TABLERO	WERZALIT SOLO	COMPACT BASIC	COMPACT PREMIUM	SEVELIT
MEDIDAS EN CM				
Ø 60	130 €	158 €	166 €	118 €
Ø 70	138 €	172 €	183 €	122 €
60 x 60	144 €	158 €	166 €	-

\* Plastificado standard blanco o negro.

Colores especiales **incremento 5 €**



Silla BILROS blanco. Mesa M3045 (amarillo, turquesa y verde) tablero Werzalit Ø70 cm. ponderosa blanco.





Silla BILROS. Mesa M3046 (amarillo, turquesa y verde) tablero Compact 60x60 cm.

# M3046

Armazón de aluminio fundido plastificado\*.

Ver acabados en carta de colores.

Características:

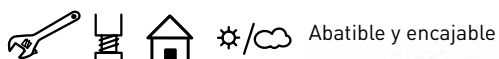

75



Turquesa



Amarillo



Verde

TABLERO MEDIDAS EN CM	WERZALIT SOLO	COMPACT BASIC	COMPACT PREMIUM	SEVELIT
Ø 70	170 €	204 €	215 €	154 €
Ø 80	175 €	231 €	243 €	-
60 x 60	175 €	190 €	198 €	-
70 x 70	189 €	205 €	215 €	170 €
80 x 80	202 €	231 €	243 €	182 €

\* Plastificado standard blanco o negro.  
Colores especiales **incremento 5 €**

# M360

Armazón: Resina color blanco.

Ver acabados en carta de colores.

Características:    

  
73



TABLERO MEDIDAS EN CM	WERZALIT SOLO	SEVELIT
70 x 70	100 €	81 €
80 x 80	113 €	92 €
110 x 70	127 €	-
115 x 70	-	93 €
120 x 80	149 €	-

# M412

Armazón de aluminio. Plástico en color aluminio.\*

Ver acabados en carta de colores.

Características:     

  
75



Aluminio



Oxidón



Blanco

TABLERO MEDIDAS EN CM	WERZALIT SOLO	MADERA TEKA	COMPACT BASIC	COMPACT PREMIUM
70 x 70	-	196 €	197 €	206 €
80 x 80	204 €	227 €	233 €	245 €
120 x 80	255 €	304 €	280 €	292 €

\* Plástico color aluminio.

Resto colores **incremento 14 €**

# M3115

Armazón: 100% Polipropileno inyectado a gas.

Ver acabados en carta de colores.

Características:



Tórtola



Antracita



Blanco



75

TABLERO	WERZALIT SOLO	COMPACT BASIC	COMPACT PREMIUM	SEVELIT
70 x 70	168 €	184 €	193 €	149 €
80 x 80	181 €	209 €	222 €	161 €
110 x 70	196 €	232 €	244 €	-
115 x 70	-	-	-	162 €
120 x 80	219 €	244 €	256 €	-

# M403

Armazón: Base de aluminio fundido sin anodizar con incrustaciones de madera de teka. Tubo de aluminio anodizado.

Ver acabados en carta de colores.

Características:

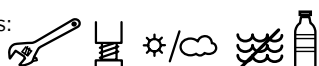

A-9400 Accesorio Colgador bolsos

Precio Colgador 13 €



74

TABLERO	WERZALIT SOLO	ACERO INOXIDABLE REPULSADO	MADERA TEKA	COMPACT BASIC	COMPACT PREMIUM	SEVELIT
Ø 60	110 €	98 €	129 €	138 €	146 €	98 €
Ø 70	118 €	114 €	146 €	152 €	163 €	102 €
60 x 60	123 €	100 €	131 €	138 €	146 €	-



## M415

Armazón de aluminio plastificado. Color caña.

Ver acabados en carta de colores.

Características:



74



TABLERO	WERZALIT SOLO	MADERA TEKA	COMPACT BASIC	COMPACT PREMIUM
MEDIDAS EN CM				
Ø 60	86 €	105 €	115 €	122 €
Ø 70	95 €	122 €	130 €	139 €

## M416

Armazón de aluminio plastificado. Color caña.

Ver acabados en carta de colores.

Características:



74



TABLERO	WERZALIT SOLO	MADERA TEKA	COMPACT BASIC	COMPACT PREMIUM
MEDIDAS EN CM				
Ø 70	104 €	115 €	125 €	132 €
Ø 80	110 €	132 €	138 €	149 €
Ø 90	127 €	-	165 €	178 €
60 x 60	110 €	117 €	125 €	132 €
70 x 70	123 €	138 €	139 €	149 €
80 x 80	136 €	160 €	165 €	178 €

## M417

Armazón de aluminio plastificado. Color caña.

Ver acabados en carta de colores.

Características:



74





TABLERO	WERZALIT SOLO	MADERA TEKA	COMPACT BASIC	COMPACT PREMIUM
MEDIDAS EN CM				
110 x 70	173 €	-	209 €	222 €
120 x 80	197 €	245 €	222 €	234 €

# M3543

Armazón de tubo acerado plastificado\*.

Ver acabados en carta de colores.

Características:  



  
75



TABLERO	WERZALIT SOLO	COMPACT BASIC	COMPACT PREMIUM	SEVELIT
MEDIDAS EN CM				
Ø 60	123 €	152 €	159 €	112 €
Ø 70	132 €	166 €	176 €	116 €

\* Plastificado standard blanco o negro.  
Colores especiales **incremento 5 €**

# M3544

Armazón de tubo acerado plastificado\*.

Ver acabados en carta de colores.

Características:  



  
75

TABLERO	WERZALIT SOLO	COMPACT BASIC	COMPACT PREMIUM	SEVELIT
MEDIDAS EN CM				
Ø 60	131 €	159 €	167 €	119 €
Ø 70	139 €	173 €	184 €	123 €
60 x 60	145 €	159 €	167 €	-
70 x 70	158 €	174 €	184 €	139 €
80 x 80	171 €	200 €	212 €	151 €

\* Plastificado standard blanco o negro.  
Colores especiales **incremento 5 €**



Sillón M2127. Mesa M3544 cobre, tablero compact 70x70 cm. álamo.

Los precios pueden estar desactualizados. Llámamos al 91 161 03 04 para consultar los precios en vigor.

# M426

Armazón: Base de acero inoxidable. Tubo de aluminio recubierto con médula sintética 100% virgen, no reciclada, tejida a mano.  
Colores columna: Natural y java.

Ver acabados en carta de colores.

Características:    

T  
74

TABLERO MEDIDAS EN CM	WERZALIT SOLO	WERZALIT LINEO
Ø 60	152 €	156 €
Ø 70	161 €	168 €
Ø 80	166 €	183 €
Ø 90	183 €	194 €
60 x 60	166 €	175 €
70 x 70	180 €	192 €



# M427

Armazón: Base de acero inoxidable. Tubo de aluminio recubierto con médula sintética 100% virgen, no reciclada, tejida a mano.  
Colores columna: Natural y java.

Ver acabados en carta de colores.

Características:    

T  
74

TABLERO MEDIDAS EN CM	WERZALIT SOLO	WERZALIT LINEO
Ø 60	151 €	155 €
Ø 70	159 €	167 €
Ø 80	165 €	182 €
Ø 90	182 €	193 €
60 x 60	165 €	174 €
70 x 70	179 €	191 €
80 x 80	191 €	207 €



# V3 ARTZ

Armazón: Poliamida por inyección y reforzado con fibra de vidrio.

Colores: Blanco, ecrú y negro.

Tablero: Compact basic

Colores: Blanco, gris niebla y negro.

Características: 

\* Posibilidad de combinar patas y tableros entre sí.



73

TABLERO	COMPACT BASIC
MEDIDAS EN CM	
59 x 59	178 €
69 x 69	200 €
79 x 79	227 €
119 x 69	280 €



Negro



Ecrú



Blanco

# M327

Armazón: Base y tubo de aluminio anodizado. Sistema "Flat" incorporado en la base, evita que la mesa cojee.

Ver acabados en carta de colores.

Características:

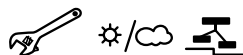

73



Sistema mod.327



NUNCA COJEA  
SISTEMA PATENTADO  
NOVEDAD MUNDIAL



A-9400 Accesorio Colgador bolsos

Precio Colgador 13 €

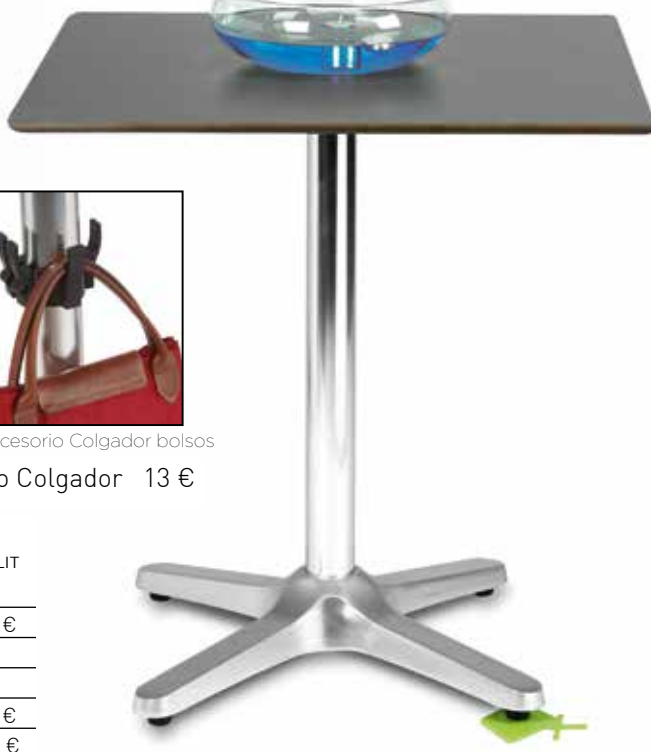

TABLERO	WERZALIT SOLO	ACERO INOXIDABLE REPULSADO	MADERA TEKA	COMPACT BASIC	COMPACT PREMIUM	SEVELIT
MEDIDAS EN CM						
Ø 70	305 €	300 €	332 €	339 €	349 €	289 €
Ø 80	310 €	309 €	351 €	365 €	378 €	-
60 x 60	310 €	287 €	317 €	325 €	332 €	-
70 x 70	324 €	302 €	334 €	340 €	349 €	305 €
80 x 80	337 €	312 €	360 €	365 €	378 €	316 €

# M3010

## sistema **es.Table**

Armazón de tubo acerado.

Sistema **es.Table\***: Estabilizador anticojeo idóneo hasta 1,5 cm. de irregularidades en el suelo.

Ver acabados en carta de colores.

Características:    **es.Table\***

T  
75



Video demostrativo en página web



TABLEROS	WERZALIT SOLO	CHAPADO HAYA CANTO HAYA
MEDIDAS EN CM	PLASTIFICADO STANDARD*	PLASTIFICADO STANDARD*
70 x 70	217 €	214 €
80 x 80	229 €	232 €
90 x 90	275 €	-
110 x 70	312 €	317 €
120 x 80	335 €	338 €
ACABADO CROMADO INCREMENTO		118 €

\* Plástico standard blanco o negro.

Colores especiales **incremento 5 €**

**NUNCA COJEA**  
**SISTEMA PATENTADO**  
**NOVEDAD MUNDIAL**

\* Sistema estabilizador anticojeo

# M3510

## sistema **es.Table**

Armazón de tubo de aluminio.

Plastificado en color aluminio.

Sistema **es.Table\***: Estabilizador anticojeo idóneo hasta 1,5 cm. de irregularidades en el suelo.

Ver acabados en carta de colores.

Características:     **es.Table\***

□  
76



Video demostrativo en página web

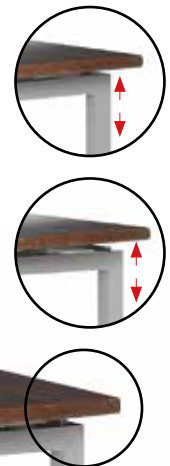

TABLERO	WERZALIT SOLO	COMPACT BASIC	COMPACT PREMIUM	CHAPADO HAYA CANTO HAYA
MEDIDAS EN CM				
70 x 70	245 €	261 €	271 €	242 €
80 x 80	258 €	287 €	299 €	260 €
90 x 90	304 €	341 €	347 €	-



**NO MÁS CUÑAS**



**NUNCA COJEA**  
**SISTEMA PATENTADO**  
**NOVEDAD MUNDIAL**

\* Sistema estabilizador anticojeo



# M3500

# sistema **es.Table**

Armazón de tubo de aluminio anodizado.

Sistema **es.Table\***: Estabilizador anticojeo idóneo hasta 1,5 cm. de irregularidades en el suelo.

Ver acabados en carta de colores.

Características:

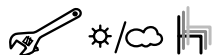

**es.Table\***



TABLERO MEDIDAS EN CM	WERZALIT SOLO	ACERO INOXIDABLE REPULSADO	MADERA TEKA	COMPACT BASIC	COMPACT PREMIUM	SEVELIT
70 x 70	201 €	179 €	216 €	217 €	226 €	182 €
80 x 80	214 €	189 €	237 €	242 €	355 €	193 €

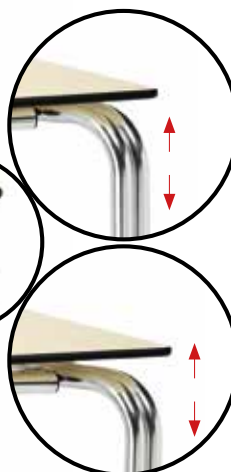

**NUNCA COJEA**  
**SISTEMA PATENTADO**  
**NOVEDAD MUNDIAL**

\*Sistema estabilizador anticojeo

**NO MÁS  
CUÑAS**



Video demostrativo  
en página web



# PRIME

Armazón: Patas de aluminio anodizado.  
Tablero: Polipropileno 100% inyectado a gas.  
Con tapón para sombrilla.  
Medida: 70 x 70 cm.

Características:

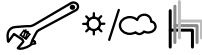

Naranja



72

Precio 57 €



Arena



Azul



Blanco



Granate



Negro



Rojo



Verde Nilo

# M3110

Armazón y tablero: 100% Polipropileno inyectado a gas.  
Medida: 70 x 70 cm

Características:

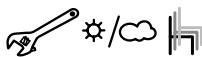

Blanco



Antracita



74





Precio 103 €



Tórtola

# M3504

Armazón: Base y columna de aluminio plastificado.  
Color aluminio.  
Ver acabados en carta de colores.

Características:     Abatible y encajable

T  
71



Video mod.  
3504 / 3505 / 3506



\*Sistema estabilizador anticojeo

TABLEROS	WERZALIT SOLO	ACERO INOXIDABLE REPULSADO	COMPACT BASIC	COMPACT PREMIUM	SEVELIT
Ø 70	335 €	331 €	369 €	380 €	320 €
Ø 80	341 €	340 €	396 €	409 €	-
70 x 70	355 €	332 €	370 €	380 €	335 €
80 x 80	367 €	343 €	396 €	409 €	347 €

NUNCA COJEA  
SISTEMA PATENTADO  
NOVEDAD MUNDIAL



# M3505

Armazón: Base y columna de aluminio plastificado.  
Color aluminio.  
Ver acabados en carta de colores.

Características:    

T  
71



Video mod.  
3504 / 3505 / 3506



\*Sistema estabilizador anticojeo

TABLEROS	WERZALIT SOLO	ACERO INOXIDABLE REPULSADO	COMPACT BASIC	COMPACT PREMIUM	SEVELIT
Ø 70	295 €	291 €	329 €	340 €	279 €
Ø 80	300 €	299 €	356 €	368 €	-
70 x 70	314 €	291 €	330 €	340 €	295 €
80 x 80	327 €	303 €	356 €	368 €	307 €

NUNCA COJEA  
SISTEMA PATENTADO  
NOVEDAD MUNDIAL



# M3506

Armazón: Base y columna de aluminio plastificado.  
Color negro.  
Ver acabados en carta de colores.

Características:    

T  
71



Video mod.  
3504 / 3505 / 3506



\*Sistema estabilizador anticojeo

TABLEROS	WERZALIT SOLO	ACERO INOXIDABLE REPULSADO	COMPACT BASIC	COMPACT PREMIUM	SEVELIT
Ø 70	264 €	260 €	298 €	309 €	249 €
Ø 80	270 €	269 €	325 €	338 €	-
70 x 70	284 €	261 €	299 €	309 €	264 €
80 x 80	296 €	272 €	325 €	338 €	276 €

NUNCA COJEA  
SISTEMA PATENTADO  
NOVEDAD MUNDIAL





# M18

Armazón: Madera de pino barnizada. Patas torneadas.

Colores: Antracita, blanco, miel y nogal.

Tablero: Chapado y cantos macizados en pino /  
Tablero Ø 120 en DM y chapado en pino.

Características:  

\*consultar plazo entrega

ARMAZÓN  
Y TABLERO  
COMBINABLES

MEDIDAS EN CM	NOGAL Y MIEL	ANTRACITA, BLANCO Y COMBINACIONES
70 x 70	147 €	171 €
80 x 80	153 €	179 €
90 x 90	167 €	193 €
110 x 70	167 €	192 €
120 x 80	182 €	209 €
Ø 120	238 €	269 €





# M40

Armazón: Madera de haya barnizada.

Tablero: DM Chapado en haya.

Color: Nogal.

Características:  



MEDIDAS EN CM	PRECIO
Ø 70	206 €
Ø 80	219 €
70 x 70	206 €
80 x 80	220 €





# M41

Armazón: Madera de haya barnizada.

Tablero: DM Chapado en haya.

Color: Nogal.

Características:  



MEDIDAS EN CM	PRECIO
110 x 70	344 €
120 x 80	359 €



## M46

Armazón: Madera de haya barnizada.

Tablero: Chapado y cantos macizados en haya, de 30 mm de espesor.

Colores: Antracita, blanco, nogal, miel y wengué.

Características: 

\* Consultar plazo de entrega.



MEDIDAS EN CM	WENGUÉ, NOGAL Y MIEL	ANTRACITA, BLANCO Y COMBINACIONES
70 x 70	165 €	181 €
80 x 80	180 €	197 €
90 x 90	202 €	225 €
110 x 70	199 €	221 €
120 x 80	219 €	245 €

ARMAZÓN  
Y TABLERO  
COMBINABLES



Blanco/Nogal



Antracita/Miel



Blanco/Blanco



Blanco/Antracita

EJEMPLOS DE COMBINACIÓN PARA MESAS MOD. 17, MOD. 18 y MOD. 46



Silla M1805 combinable. Mesa M46 70x70 cm combinable.



# M17

Armazón: Madera de pino barnizada. Patas cuadradas.

Tablero: Chapado y cantos macizados en pino. /

Tablero Ø 120 en DM y chapado en pino.

Colores: Antracita, blanco, miel y nogal.

Características:

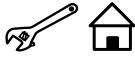

\*consultar plazo entrega

MEDIDAS EN CM	NOGAL Y MIEL	ANTRACITA, BLANCO Y COMBINACIONES
70 x 70	134 €	158 €
80 x 80	140 €	166 €
90 x 90	154 €	181 €
110 x 70	154 €	180 €
120 x 80	169 €	197 €
Ø 120	226 €	257 €

ARMAZÓN  
Y TABLERO  
COMBINABLES



Blanco/Blanco



Blanco/Nogal



Antracita/Miel



Blanco/Antracita

# M3845

Armazón: Patas de madera de Haya.

Colores: Antracita, blanco, miel, natural y nogal.

Tablero: Tablón pino macizo canto irregular 25 mm.

Colores Tablero: Natural, miel y nogal.

Características:



\*consultar plazo entrega

\*consultar otros acabados



MEDIDAS EN CM	TABLON PINO MACIZO CANTO IRREGULAR 25 MM
70 x 70	223 €
80 x 80	232 €
110 x 70	253 €
120 x 80	276 €



Natural/Miel



Antracita/Natural



## M3840

Armazón: Madera de haya barnizada.

Color: Natural, natural nórdico, nogal y wengué.

Tablero: Haya pintada con canto perfilado.

Colores: Antracita y blanco.

Características:



MEDIDAS EN CM	PRECIO
70 x 70	197 €
80 x 80	207 €
110 x 70	225 €
120 x 80	255 €



Natural Nórdico/Antracita



Natural/Blanco

## M3050

Armazón de tubo acerado con patas torneadas en madera de haya.

Color tubo acerado y patas de madera:

Según carta.

Tablero: Haya barnizada con canto perfilado.

Colores: Nogal y Wengué.

Tablero: Haya pintada con canto perfilado.

Colores: Antracita y blanco.

Características:



\* Consultar otros acabados.

MEDIDAS EN CM	PRECIO
70 x 70	271 €
80 x 80	285 €
110 x 70	315 €
120 x 80	329 €



Silla M1844 antracita, asiento Kapa antracita. Mesa M3050 70x70 cm. patas natural, tablero antracita.



## ESPECIFICACIONES TÉCNICAS

TECHNICAL SHEET | SPÉCIFICATIONS TECHNIQUES

### ORFEO

Sillón multiposiciones plegable con seguro. Inyectado en polipropileno. 5 posiciones. Protección UV.

Folding multi-position armchair with save lock. Injected in polypropylene. 5 positions. UV Protection.

Fauteuil multipositions pliant avec système de sécurité. Injectée en polypropylène. 5 positions. Protection UV.



- 04455 Antracita Anthracite Anthracite
- 01145 Blanco White Blanc

W 62,5 cm | W 24.61 in  
L 65 cm | L 25.59 in  
H 108 cm | H 42.52 in

STD units	Packaging dim. (cm)	M3/ pack	NW units (kg)	Units Container 20'	Units Container 40'	Units Container HC	Units Truck 70m³	Units Truck 100m³
4	63x59x91	0,34	5,22	344	668	740	800	1120

### EGEO

Silla para uso interior y exterior. Acero pintado por pulverización.

Chair for indoor and outdoor use. Powder coated steel structure.

Chaise pour usage intérieur et extérieur. En acier peint par pulvérisation.

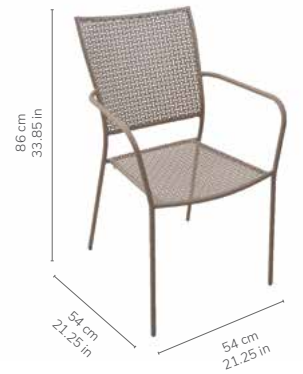

- 59610 Arena Sand Sable
- 59611 Blanco White Blanc

W 54 cm | W 21.25 in  
L 54 cm | L 21.25 in  
H 86 cm | H 33.85 in

Apilable Stackable | Empilable

STD units	Packaging dim. (cm)	M3/ pack	NW units (kg)	Units Container 20'	Units Container 40'	Units Container HC	Units Truck 70m³	Units Truck 100m³
4	73,7x60,7x96,9	0,43	4,50	260	548	632	652	912
30	54x54x200	0,58	4,50	1280	2688	2688	3072	3584

### SAMOA

Silla para uso interior y exterior con textilene 2x1. Aluminio pintado por pulverización.

Armchair for indoor and outdoor use with 2x1 textilene. Powder coated aluminium.

Chaise pour usage intérieur et extérieur avec toile doubletrame. En aluminium peint par pulvérisation.



- 59613 Gris Oscuro Dark Grey Gris Foncé

W 56 cm | W 22.04 in  
L 56 cm | L 22.04 in  
H 88 cm | H 34.64 in

Apilable Stackable | Empilable

STD units	Packaging dim. (cm)	M3/ pack	NW units (kg)	Units Container 20'	Units Container 40'	Units Container HC	Units Truck 70m³	Units Truck 100m³
2	66x60x90	0,36	3,3	108	240	240	492	492
4	74x60x97	0,44	3,3	108	240	240	312	348
36	60x60x200	0,72	3,3	-	-	1.232	-	-

W: ancho / width / largeur. L: largo / length / longueur. H: altura / height / hauteur. Hs: altura asiento / seat height / hauteur du siège. Ha: altura brazo / arm height / hauteur du bras. Ø: diámetro / diameter / diamètre.

## ESPECIFICACIONES TÉCNICAS

TECHNICAL SHEET | SPÉCIFICATIONS TECHNIQUES

### NOA

Mesa para uso interior y exterior. Sobre y patas inyectados en polipropileno. Patas en polipropileno y fibra de vidrio. Protección UV. Disponible en dos medidas: 90x90, 160x90.

Table for indoor and outdoor use. Table top and legs injected in polypropylene. Fiber glass in the legs. UV protection. Available in 2 sizes: 90x90, 160x90.

Table pour usage intérieur et extérieur. Plateau et pieds injectés en polypropylène. Pieds en polypropylène renforcé de fibre de verre. Protection UV. Disponible en deux dimensions: 90x90, 160x90.



W 90 cm | W 35.43 in  
L 90 cm | L 35.43 in  
H 74 cm | H 29.13 in

- 04168 Arena Sand Sable
- 04166 Blanco White Blanc
- 04170 Gris Oscuro Dark Grey Gris Foncé
- 04280 Chocolate Chocolate Chocolat

W 90 cm | W 35.43 in  
L 160 cm | L 62.99 in  
H 74 cm | H 29.13 in

- 04174 Arena Sand Sable
- 04172 Blanco White Blanc
- 04176 Gris Oscuro Dark Grey Gris Foncé
- 04282 Chocolate Chocolate Chocolat

90x90 | 11.85 kg / 26.13 lb.  
160x90 | 21.56 kg / 47.74 lb.

STD units	Packaging dim. (cm)	M3/ pack	NW units (kg)	Units Container 20'	Units Container 40'	Units Container HC	Units Truck 70m³	Units Truck 100m³
1	94x92x15	0,13	11,85	180	390	442	448	578
1	161x92x15	0,22	21,56	90	210	238	256	323

### NEW FLASH

Mesa para uso interior y exterior. Sobre inyectado en polipropileno. Patas de aluminio anodizado de alta resistencia. Estructura de acero zincado pintada por pulverización al horno testeado conforme normativa anticorrosión UNE EN/ISO 9227:2012. Protección UV. Disponible en dos medidas: 90x90, 160x90.

Table for indoor and outdoor use. Table top injected with polypropylene. High resistance anodized aluminium legs. Powder coated zinc steel structure in accordance to corrosion regulation UNE EN/ISO 9227:2012. UV Protection. Available in 2 sizes: 90x90, 160x90.

Table d'intérieur et extérieur. Plateau injecté en polypropylène. Pieds en aluminium anodisé de haute résistance. Structure d'acier zingué peint par pulvérisation au four en conformité avec la réglementation anticorrosion UNE EN/ISO 9227:2012. Protection UV. Disponible en deux dimensions: 90x90, 160x90.



W 90 cm | W 35.43 in  
L 90 cm | L 35.43 in  
H 72 cm | H 28.35 in

- 03949 Arena Sand Sable
- 01675 Blanco White Blanc
- 03948 Gris Oscuro Dark Grey Gris Foncé
- 01678 Chocolate Chocolate Chocolat

W 160 cm | W 62.99 in  
L 90 cm | L 35.43 in  
H 72 cm | H 28.35 in

- 03951 Arena Sand Sable
- 01679 Blanco White Blanc
- 03950 Gris Oscuro Dark Grey Gris Foncé
- 01680 Chocolate Chocolate Chocolat

90x90 | 11.58 kg / 25.53 lb.  
160x90 | 17.59 kg / 38.77 lb.

STD units	Packaging dim. (cm)	M3/ pack	NW units (kg)	Units Container 20'	Units Container 40'	Units Container HC	Units Truck 70m³	Units Truck 100m³
1	94x92x15	0,13	11,58	180	390	442	448	578
1	161x92x15	0,22	17,59	90	210	238	256	323

W: ancho / width / largeur. L: largo / length / longueur. H: altura / height / hauteur. Hs: altura asiento / seat height / hauteur du siège. Ha: altura brazo / arm height / hauteur du bras. Ø: diámetro / diameter / diamètre.

## NEW DESSA

Mesa para uso interior y exterior. Sobre inyectado en polipropileno. Patas de aluminio anodizado de alta resistencia. Estructura de acero zincado pintada por pulverización al horno testeado conforme normativa anticorrosión UNE EN/ISO 9227:2012. Protección UV. Disponible en 2 medidas: 90x90, 160x90.

Table for indoor and outdoor use. Table top injected with polypropylene. High resistance anodized aluminium legs. Powder coated zinc steel structure in accordance to corrosion regulation UNE EN/ISO 9227:2012. UV Protection. Available in two sizes: 90x90, 160x90.

Table d'intérieur et extérieur. Plateau injecté en polypropylène. Pieds en aluminium anodisé de haute résistance. Structure d'acier zingué peint par pulvérisation au four en conformité avec la réglementation anticorrosion UNE EN/ISO 9227:2012. Protection UV. Disponible en deux dimensions: 90x90, 160x90.



W 90 cm W 35.43 in  
L 90 cm L 35.43 in  
H 74 cm H 29.13 in

● 03945 Arena Sand Sable  
● 01681 Blanco White Blanc  
● 03944 Gris Oscuro Dark Grey Gris Foncé  
● 01682 Chocolate Chocolate Chocolat

W 160 cm W 62.99 in  
L 90 cm L 35.43 in  
H 74 cm H 29.13 in

● 03947 Arena Sand Sable  
● 01688 Blanco White Blanc  
● 03946 Gris Oscuro Dark Grey Gris Foncé  
● 01689 Chocolate Chocolate Chocolat

● 90x90 | 9.1 kg / 20.06 lb.  
● 160x90 | 11.56 kg / 25.48 lb.

STD units	Packaging dim. (cm)	M3/ pack	NW units (kg)	Units Container 20'	Units Container 40'	Units Container HC	Units Truck 70m³	Units Truck 100m³
1	92x94x15	0,13	11,74	180	390	442	448	578
1	161x92x15	0,22	16,75	90	210	238	256	323

## VEGAS

Mesa extensible en polipropileno reforzado con fibra de vidrio. Tres opciones de tamaño. Para uso en interiores y exteriores con protección UV.

Extendible table in polypropylene reinforced with glass fiber. Easily expandable. Three size options. For indoor and outdoor use with UV protection.

Table extensible en polypropylène renforcée en fibre de verre. Facilement extensible. Trois tailles. Pour une utilisation intérieure et extérieure, protection UVA.



● S - 60259 Blanco  
● M - 60264 White  
● L - 60269 Blanc

VEGAS S  
W 100-140 cm W 39.37-55.11 in  
L 100 cm L 39.37 in  
H 75 cm H 29.53 in

● S - 60261 Gris Oscuro  
● M - 60266 Dark Grey  
● L - 60271 Gris Foncé

VEGAS M  
W 180-220 cm W 70.87-86.61 in  
L 100 cm L 39.37 in  
H 75 cm H 29.53 in

● S - 60263 Chocolate  
● M - 60268 Chocolate  
● L - 60273 Chocolat

VEGAS L  
W 260-300 cm W 102.36-118.11 in  
L 100 cm L 39.37 in  
H 75 cm H 29.53 in

● S | 29 kg. / 63.95 lb.  
● M | 40 kg. / 88.2 lb.  
● L | 51 kg. / 112.45 lb.

STD units	Packaging dim. (cm)	M3/ pack	NW units (kg)	Units Container 20'	Units Container 40'	Units Container HC	Units Truck 70m³	Units Truck 100m³
1	151x105x14	0,22	29	125	-	315	375	-
1	151x105x19	0,30	40	95	-	235	275	-
1	182x105x20	0,38	51	85	-	200	235	-

## RODAS

Mesa de lamas extensible para uso interior y exterior. Aluminio pintado por pulverización.

Slat extendable table for indoor and outdoor use. Powdercoated aluminium.

Tables extensible à lattes pour usage intérieur et extérieur. En aluminium peint par pulvérisation.



● 59612 Gris Oscuro Dark Grey Gris Foncé

W 100 cm W 39.37 in  
L 173 cm L 68.11 in  
H 252 cm H 99.21 in

● 20 kg. / 44.1 lb.

STD units	Packaging dim. (cm)	M3/ pack	NW units (kg)	Units Container 20'	Units Container 40'	Units Container HC	Units Truck 70m³	Units Truck 100m³
1	181X108X13	0,254	20	110	225	249	256	374

W: ancho / width / largeur. L: largo / length / longueur. H: altura / height / hauteur. Hs: altura asiento / seat height / hauteur du siège. Ha: altura brazo / arm height / hauteur du bras. Ø: diámetro / diameter / diamètre.

## EGEO

Mesa para uso interior y exterior de 70x70 cm. Estructura de acero pintado por pulverización.

Table for indoor and outdoor use of 70x70 cm. Powder coated steel structure.

Table pour usage intérieur et extérieur de 70x70 cm. Structure en acier peint par pulvérisation.

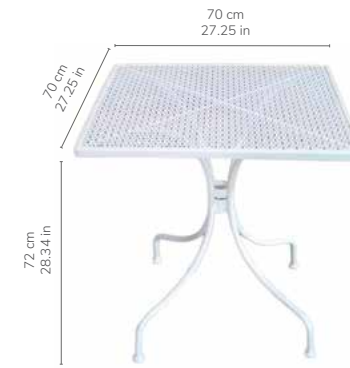

● 59608 Arena Sand Sable  
● 59609 Blanco White Blanc

W 70 cm W 27.25 in  
L 70 cm L 27.25 in  
H 72 cm H 28.34 in

● 6.5 kg / 14.33 lb.

STD units	Packaging dim. (cm)	M3/ pack	NW units (kg)	Units Container 20'	Units Container 40'	Units Container HC	Units Truck 70m³	Units Truck 100m³
1	77X72X9	0,05	6,50	624	1248	1392	1458	1848

## DALIA

Mesa rectangular inyectada en polipropileno con patas enlazadas para mayor estabilidad. Agujero parasol 38 mm. Protección UV

Rectangular table injected in polypropylene with linked legs to give more stability. Hole for umbrella 38 mm. UV Protection.

Table rectangulaire injectée en polypropylène avec jambes croisées pour plus de stabilité. Avec trou de parasol 38 mm. Protection UV.



● 05257 Antracita Anthracite Anthracite  
● 05256 Blanco White Blanc

W 72 cm W 28.35 in  
L 115 cm L 45.28 in  
H 74 cm H 29.13 in

● 8.24KG / 18.16

Hole Ø 3,8 cm Hole Ø 1.50 in

STD units	Packaging dim. (cm)	M3/ pack	NW units (kg)	Units Container 20'	Units Container 40'	Units Container HC	Units Truck 70m³	Units Truck 100m³
1	115x72x13.5	0,12	-	263	520	600	750	840
17	116x75x240	2,07	-	-	-	544	646	731

## TULIPAN

Mesa rectangular inyectada en polipropileno con patas enlazadas para mayor estabilidad. Agujero parasol 38 mm. Protección UV

Rectangular table injected in polypropylene with linked legs to give more stability. Hole for umbrella 38 mm. UV Protection.

Table rectangulaire injectée en polypropylène avec jambes croisées pour plus de stabilité. Avec trou de parasol 38 mm. Protection UV.



● 05255 Antracita Anthracite Anthracite  
● 05254 Blanco White Blanc

W 90 cm W 35.43 in  
L 140 cm L 55.12 in  
H 74 cm H 29.13 in

Hole Ø 3,8 cm Hole Ø 1.50 in

● 11.24KG / 24.77 lb

● Apilable Stackable | Empilable

STD units	Packaging dim. (cm)	M3/ pack	NW units (kg)	Units Container 20'	Units Container 40'	Units Container HC	Units Truck 70m³	Units Truck 100m³
1	140x90x13.5	0,17	-	170	360	395	510	550
17	141x91x240	3,02	-	-	-	357	442	493

W: ancho / width / largeur. L: largo / length / longueur. H: altura / height / hauteur. Hs: altura asiento / seat height / hauteur du siège. Ha: altura brazo / arm height / hauteur du bras. Ø: diámetro / diameter / diamètre.

## ESPECIFICACIONES TÉCNICAS

TECHNICAL SHEET | SPÉCIFICATIONS TECHNIQUES

### ORQUIDIA

Mesa rectangular inyectada en polipropileno con patas enlazadas para mayor estabilidad. Agujero parasol 38 mm. Protección UV.

Rectangular table injected in polypropylene with linked legs to give more stability. Hole for umbrella 38 mm. UV Protection.

Table rectangulaire injectée en polypropylène avec jambes croisées pour plus de stabilité. Avec trou de parasol 38 mm. Protection UV.



- 05253  
Antracita  
Anthracite  
Anthracite
- 05252  
Blanco  
White  
Blanc

W 90 cm      W 35.43 in  
L 180 cm     L 70.87 in  
H 74 cm      H 29.13 in  
Hole Ø 3,8 cm    Hole Ø 1.50 in

14,7KG / 32.14 lb  
 Apilable  
Stackable | Empilable

STD units	Packaging dim. (cm)	M3/ pack	NW units (kg)	Units Container 20'	Units Container 40'	Units Container HC	Units Truck 70m³	Units Truck 100m³
1	180x90x13.5	0,22	-	130	270	300	380	390
17	181x91x240	3,89	-	-	-	221	272	289

### JAZMIN

Mesa redonda inyectada en polipropileno con patas enlazadas para mayor estabilidad. Agujero parasol 38 mm. Protección UV.

Round table injected in polypropylene with linked legs to give more stability. Hole for umbrella 38 mm. UV Protection.

Table ronde injectée en polypropylène avec jambes croisées pour plus de stabilité. Avec trou de parasol 38 mm. Protection UV.



- 05251  
Antracita  
Anthracite  
Anthracite
- 05250  
Blanco  
White  
Blanc

W 100 cm      W 39.37 in  
L 100 cm      L 39.37 in  
H 74 cm      H 29.13 in  
Hole Ø 3,8 cm    Hole Ø 1.50 in

9,22KG / 20.33 lb  
 Apilable  
Stackable | Empilable

STD units	Packaging dim. (cm)	M3/ pack	NW units (kg)	Units Container 20'	Units Container 40'	Units Container HC	Units Truck 70m³	Units Truck 100m³
1	100x100x13.5	0,135	-	205	450	500	630	700
17	101x101x240	2,43	-	-	-	408	476	544

### SEVILLA

Mesa rectangular inyectada en polipropileno. Agujero para parasol de 38 mm.

Rectangular table injected in polypropylene. Hole for umbrella 38 mm.

Table rectangulaire injectée en polypropylène. Avec trou de parasol 38 mm.



- 04486  
Antracita  
Anthracite  
Anthracite
- 01287  
Blanco  
White  
Blanc

W 90 cm      W 35.43 in      9,4 kg. /20.72 lb.  
L 180 cm     L 70.87 in  
H 73 cm      H 28.74 in

STD units	Packaging dim. (cm)	M3/ pack	NW units (kg)	Units Container 20'	Units Container 40'	Units Container HC	Units Truck 70m³	Units Truck 100m³
1	180x90x8.5	0,14	9,40	156	338	377	405	476
10	180x90x70	1,13	9,40	180	390	390	450	510
42	180x90x240	3,89	9,40	-	-	315	360	435

W: ancho / width / largeur. L: largo / length / longueur. H: altura / height / hauteur. Hs: altura asiento / seat height / hauteur du siège. Ha: altura brazo / arm height / hauteur du bras. Ø: diámetro / diameter / diamètre.

## ESPECIFICACIONES TÉCNICAS

TECHNICAL SHEET | SPÉCIFICATIONS TECHNIQUES

### OLOT

Mesa rectangular inyectada en polipropileno. Agujero para parasol de 38 mm.

Rectangular table injected in polypropylene. Hole for umbrella 38 mm.

Table rectangulaire injectée en polypropylène. Avec trou de parasol 38 mm.



- 04433  
Antracita  
Anthracite  
Anthracite
- 01284  
Blanco  
White  
Blanc
- 01286  
Verde Oscuro  
Dark Green  
Vert Foncé

W 90 cm      W 35.43 in      7,5 kg / 16.53 lb.  
L 140 cm     L 55.12 in  
H 73 cm      H 28.74 in

STD units	Packaging dim. (cm)	M3/ pack	NW units (kg)	Units Container 20'	Units Container 40'	Units Container HC	Units Truck 70m³	Units Truck 100m³
1	140x90x8,5	0,11	7,50	260	546	609	648	784
20	140x90x125	0,16	7,50	200	420	420	960	1120
44	140x90x254	3,20	7,50	-	-	924	1056	1232

### BRAVA

Mesa ovalada inyectada en polipropileno. Patas ajustadas a presión. Agujero parasol 38 mm.

Oval table injected in polypropylene. Pressure-fitted legs. Hole for umbrella 38 mm.

Table ovale injectée en polypropylène. Pieds emboîtés à pression. Avec trou de parasol 38 mm.



- 04468  
Antracita  
Anthracite  
Anthracite
- 01249  
Blanco  
White  
Blanc

W 90 cm      W 35.43 in      8,7 kg / 19.18 lb.  
L 180 cm     L 70.87 in  
H 73 cm      H 28.74 in

STD units	Packaging dim. (cm)	M3/ pack	NW units (kg)	Units Container 20'	Units Container 40'	Units Container HC	Units Truck 70m³	Units Truck 100m³
2	180x90x8,5	0,14	8,70	156	338	377	405	476
40	180x90x233	3,77	8,70	-	-	315	360	435

### GALA

Mesa ovalada inyectada en polipropileno. Patas ajustadas a presión. Agujero para parasol de 38 mm.

Oval table injected in polypropylene. Pressure-fitted legs. Hole for umbrella 38 mm.

Table ovale injectée en polypropylène. Pieds emboîtés à pression. Avec trou de parasol 38 mm.



- 04408  
Antracita  
Anthracite  
Anthracite
- 00152  
Blanco  
White  
Blanc
- 01091  
Verde Oscuro  
Dark Green  
Vert Foncé

W 90 cm      W 35.43 in      6,4 kg. / 14.11 lb.  
L 140 cm     L 55.12 in  
H 73 cm      H 28.74 in

STD units	Packaging dim. (cm)	M3/ pack	NW units (kg)	Units Container 20'	Units Container 40'	Units Container HC	Units Truck 70m³	Units Truck 100m³
4	140x90x19	0,24	6,45	120	252	294	312	676
20	140x90x110	1,39	6,45	200	420	420	960	1120
50	140x90x242	3,05	6,45	-	-	315	360	435

### TOSSA

Mesa redonda inyectada en polipropileno. Patas ajustadas a presión. Agujero para parasol de 38 mm.

Round table injected in polypropylene. Pressure-fitted legs. Hole for umbrella 38 mm.

Table ronde injectée en polypropylène. Pieds emboîtés à pression. Avec trou de parasol 38 mm.



- 04424  
Antracita  
Anthracite  
Anthracite
- 00184  
Blanco  
White  
Blanc
- 01093  
Verde Oscuro  
Dark Green  
Vert Foncé

Ø 86 cm      Ø 33.86 in      4,9 kg / 10.80 lb.  
H 73 cm      H 28.74 in

STD units	Packaging dim. (cm)	M3/ pack	NW units (kg)	Units Container 20'	Units Container 40'	Units Container HC	Units Truck 70m³	Units Truck 100m³
4	88x87x19	0,15	4,90	144	312	364	390	425
20	115x112x105	1,35	4,90	200	400	400	480	560
50	115x112x240	3,09	4,90	-	-	1000	1200	1400

## ESPECIFICACIONES TÉCNICAS

TECHNICAL SHEET | SPÉCIFICATIONS TECHNIQUES

### BANYOLES

Mesa de polipropileno con pie central embutido.

Polypropylene table with pressure-fitted pedestal.

Table pour guéridon de polypropylène avec pied central emboîté.



04200 Antracita Anthracite Anthracite  
00133 Blanco White Blanc

Ø 60 cm Ø 23.62 in  
H 73 cm H 28.74 in

6.6 kg / 14.55 lb.

STD units	Packaging dim. (cm)	M3/ pack	NW units (kg)	Units Container 20'	Units Container 40'	Units Container HC	Units Truck 70m³	Units Truck 100m³
1	77x61x15	0,07	6,65	405	855	969	1056	1410
30	140x115x150	2,42	6,65	240	480	480	540	660

### ESCULAPI

Mesa para uso exterior inyectada en polipropileno con pie central embutido con gran estabilidad. Disponible en redonda de Ø70 cm y cuadrada de 70x70 cm.

Table for outdoor use injected in polypropylene with pressure-fitted pedestal base with great stability. Available in round Ø70 cm and squared 70x70 cm.

Table pour usage extérieur, injectée en polypropylène avec pied central emboîté et grande stabilité. Disponible en ronde de Ø70 cm et carrée de 70x70 cm.



04348 Antracita Anthracite Anthracite  
01521 Blanco White Blanc  
04272 Antracita Anthracite Anthracite  
01522 Blanco White Blanc

7.25 kg. / 15.98 lb.

STD units	Packaging dim. (cm)	M3/ pack	NW units (kg)	Units Container 20'	Units Container 40'	Units Container HC	Units Truck 70m³	Units Truck 100m³
1	80x70x15	0,08	7,25	345	735	833	912	1173
30	140x90x222	2,80	7,25	300	630	630	720	840

### BEACH BAR

Mesa monobloc para uso exterior. Inyectada en polipropileno. Apilable. Protección UV. Con agujero para sombrilla.

Monoblock table for outdoor use. Injected in polypropylene. Stackable. UV Protection. It has a hole for umbrella.

Table monobloc pour extérieur. Injectée en polypropylène. Empilable. Protection UV. Avec trou de parasol.

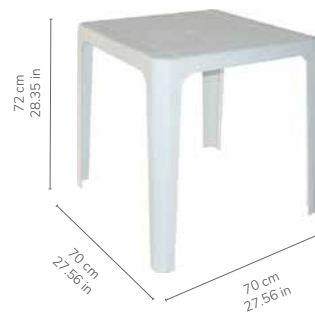

59507 Verde Oscuro Dark Green Vert Foncé  
59506 Blanco White Blanc

W 70 cm W 27.56 in  
L 70 cm L 27.56 in  
H 72 cm H 28.35 in

4.74 kg. / 10.45 lb.  
Apilable Stackable | Empilable

STD units	Packaging dim. (cm)	M3/ pack	NW units (kg)	Units Container 20'	Units Container 40'	Units Container HC	Units Truck 70m³	Units Truck 100m³
27	80x80x272	1,74	4,75	388	853	931	1009	1474

## ESPECIFICACIONES TÉCNICAS

TECHNICAL SHEET | SPÉCIFICATIONS TECHNIQUES

### JAN

Silla inyectada en polipropileno. Protección UV.

Box pallet (20 unidades):

4 verde lima / 4 azul cielo / 4 fucsia / 4 naranja / 4 aquamint.

Chair injected in polypropylene. UV Protection.

Box pallet (20 units): 4 lime green / 4 light blue / 4 fuchsia / 4 orange / 4 aquamint.

Chaise injectée en polypropylène. Protection UV.

Box palette (20 unités): 4 vert lime / 4 bleu ciel / 4 fuchsia / 4 orange / 4 aquamint.



04375 Fucsia Fuchsia Fuchsia  
04377 Naranja Orange Orange  
04379 Azul Cielo Light Blue Bleu Ciel  
04376 Aquamint Aquamint Aquamint  
04378 Verde Lima Lime Green Vert Lime

W 38,6 cm W 15.20 in  
L 38 cm L 14.96 in  
H 59,5 cm H 23.42 in  
HS 31 cm HS 12.20 in

1.43 kg / 3.15 lb.

Apilable Stackable | Empilable

STD units	Packaging dim. (cm)	M3/ pack	NW units (kg)	Units Container 20'	Units Container 40'	Units Container HC	Units Truck 70m³	Units Truck 100m³
4	80x40x45	0,14	1,43	700	1500	1800	2228	2688
Box Pallet (20)	80x60x120	0,58	1,43	520	1100	2200	2680	3200

### JAN CAT

Silla inyectada en polipropileno. Protección UV.

Box pallet (20 unidades):

4 verde lima / 4 azul cielo / 4 fucsia / 4 naranja / 4 aquamint.

Chair injected in polypropylene. UV Protection. Box pallet (20 units):

4 lime green / 4 light blue / 4 fuchsia / 4 orange / 4 aquamint.

Chaise injectée en polypropylène. Protection UV. Box palette (20 unités): 4 vert lime / 4 bleu ciel / 4 fuchsia / 4 orange / 4 aquamint.



04357 Fucsia Fuchsia Fuchsia  
04359 Naranja Orange Orange  
04361 Azul Cielo Light Blue Bleu Ciel  
04358 Aquamint Aquamint Aquamint  
04360 Verde Lima Lime Green Vert Lime

W 38,6 cm W 15.20 in  
L 38 cm L 14.96 in  
H 59,5 cm H 23.42 in  
HS 31 cm HS 12.20 in

1.43 kg / 3.15 lb.

Apilable Stackable | Empilable

STD units	Packaging dim. (cm)	M3/ pack	NW units (kg)	Units Container 20'	Units Container 40'	Units Container HC	Units Truck 70m³	Units Truck 100m³
4	80x40x45	0,14	1,43	700	1500	1800	2228	2688
Box Pallet (20)	80x60x120	0,58	1,43	520	1100	2200	2680	3200

### JAN FROG

Silla inyectada en polipropileno. Protección UV. Box pallet (20 unidades): 4 verde lima / 4 azul cielo / 4 fucsia / 4 naranja / 4 aquamint.

Chair injected in polypropylene. UV Protection. Box pallet (20 units): 4 lime green / 4 light blue / 4 fuchsia / 4 orange / 4 aquamint.

Chaise injectée en polypropylène. Protection UV. Box palette (20 unités): 4 vert lime / 4 bleu ciel / 4 fuchsia / 4 orange / 4 aquamint.



04339 Fucsia Fuchsia Fuchsia  
04341 Naranja Orange Orange  
04343 Azul Cielo Light Blue Bleu Ciel  
04340 Aquamint Aquamint Aquamint  
04342 Verde Lima Lime Green Vert Lime

W 38,6 cm W 15.20 in  
L 38 cm L 14.96 in  
H 59,8 cm H 23.54 in  
HS 31 cm HS 12.20 in

1.43 kg. / 3.15 lb.

Apilable Stackable | Empilable

STD units	Packaging dim. (cm)	M3/ pack	NW units (kg)	Units Container 20'	Units Container 40'	Units Container HC	Units Truck 70m³	Units Truck 100m³
4	80x40x45	0,14	1,43	700	1500	1800	2228	2688
Box Pallet (20)	80x60x120	0,58	1,43	520	1100	2200	2680	3200



## ESPECIFICACIONES TÉCNICAS

TECHNICAL SHEET | SPÉCIFICATIONS TECHNIQUES

### RITA

Sillón infantil para uso interior y exterior. Inyectado en polipropileno. Apilable. Protección UV. Box palet 66 unidades: 22 verde lima / 11 azul cielo / 11 rosa / 11 naranja / 11 roja.

Child armchair for indoor and outdoor use. Injected with polypropylene. Stackable. UV protection. Box pallet 66 units: 22 lime green / 11 light blue / 11 pink / 11 orange / 11 red.

Fauteuil pour enfant d'intérieur et extérieur. Injectée en polypropylène. Empilable. Protection UV. Box palette 66 unités: 22 vert lime / 11 bleu ciel / 11 rose / 11 orange / 11 rouge.



- **03502** Rojo Red Rouge
- **03503** Naranja Orange Orange
- **03505** Azul Cielo Light Blue Bleu Ciel
- **03506** Rosa Pink Rose
- **03504** Verde Lima Lime Green Vert Lime

W 38 cm W 14.96 in  
L 37 cm L 14.57 in  
H 59.7 cm H 23.50 in

1.2 kg / 2.65 lb.  
Apilable Stackable | Empilable

STD units	Packaging dim. (cm)	M3/ pack	NW units (kg)	Units Container 20'	Units Container 40'	Units Container HC	Units Truck 70m <sup>3</sup>	Units Truck 100m <sup>3</sup>
4	39,5x41x78	0,13	1,2	952	1980	2160	2440	2920
216	120x80x220	2,11	1,2	2376	5400	5400	7128	8640
Box pallet (66)	120x80x120	1,15	1,2	726	1650	3300	4356	5280

### JULIETA

Silla infantil para uso interior y exterior. Inyectada en polipropileno. Apilable. Protección UV. Box palet (60 unidades): 20 verde lima / 10 azul cielo / 10 rosa / 10 naranja / 10 roja.

Child chair for indoor and outdoor use. Injected with polypropylene. Stackable. UV Protection. Box pallet (60 units): 20 lime green / 10 light blue / 10 pink / 10 orange / 10 red.

Chaise pour enfant d'intérieur et extérieur. Injectée en polypropylène. Empilable. Protection UV. Box palette (60 unités): 20 vert lime / 10 bleu ciel / 10 rose / 10 orange / 10 rouge.



- **02385** Rojo Red Rouge
- **02386** Naranja Orange Orange
- **02390** Azul Cielo Light Blue Bleu Ciel
- **02388** Rosa Pink Rose
- **02387** Verde Lima Lime Green Vert Lime

W 37.5 cm W 14.76 in  
L 40 cm L 15.75 in  
H 58 cm H 22.83 in

1.18 kg / 2.60 lb.  
Apilable Stackable | Empilable

STD units	Packaging dim. (cm)	M3/ pack	NW units (kg)	Units Container 20'	Units Container 40'	Units Container HC	Units Truck 70m <sup>3</sup>	Units Truck 100m <sup>3</sup>
4	39,5x41x78	0,13	1,18	952	1980	2160	2440	2920
192	120x80x222	2,13	1,18	2112	4800	4800	6336	7680
Box pallet (60)	120x80x120	1,15	1,18	660	1500	3000	3960	4800

### MINI 2

Sillón infantil apilable para uso interior y exterior. Inyectado en polipropileno. Apilable. Protección UV.

Child armchair for indoor and outdoor use. Injected in polypropylene. Stackable. UV Protection.

Fauteuil pour enfant pour usage intérieur et extérieur. Injectée en polypropylène. Empilable. Protection UV.



- **60722** Rojo Red Rouge
- **60723** Azul Blue Bleu
- **60721** Verde Oscuro Dark Green Vert Foncé
- **60724** Blanco White Blanc
- **60720** Amarillo Yellow Jaune

W 38 cm W 14.96 in  
L 38 cm L 14.96 in  
H 53 cm H 20.87 in

0.7 kg / 1.54 lb.  
Apilable Stackable | Empilable

STD units	Packaging dim. (cm)	M3/ pack	NW units (kg)	Units Container 20'	Units Container 40'	Units Container HC	Units Truck 70m <sup>3</sup>	Units Truck 100m <sup>3</sup>
12	39x37x89	0,13	0,7	2760	5940	6960	8328	9600

W: ancho / width / largeur. L: largo / length / longueur. H: altura / height / hauteur. Hs: altura asiento / seat height / hauteur du siège. Ha: altura brazo / arm height / hauteur du bras. Ø: diámetro / diameter / diamètre.

## ESPECIFICACIONES TÉCNICAS

TECHNICAL SHEET | SPÉCIFICATIONS TECHNIQUES

### JAN

Mesa monobloc inyectada en polipropileno con portarotuladores con tapa extraíble. Protección UV. Superficie para dibujar con rotuladores borrables.

Box palet (10 unidades): 2 verde lima / 2 azul cielo / 2 fucsia / 2 naranja / 2 aquamint.

Table monoblock injected in polypropylene with pen tray with removable lid. UV Protection. Surface for drawing with erasable markers. Box pallet (10 units): 2 lime green / 2 light blue / 2 fuchsia / 2 orange / 2 aquamint.

Table monobloc injectée en polypropylène avec porte-marqueurs et couvercle amovible. Protection UV. Surface pour dessiner avec marqueurs non permanents. Box palette (10 unités): 2 vert lime / 2 bleu ciel / 2 fuchsia / 2 orange / 2 aquamint.



- **04387** Fucsia Fuchsia Fuchsia
- **04389** Naranja Orange Orange
- **04391** Azul Cielo Light Blue Bleu Ciel
- **04388** Aquamint Aquamint Aquamint
- **04390** Verde Lima Lime Green Vert Lime

W 69.7 cm W 27.44 in  
L 59.7 cm L 23.50 in  
H 53 cm H 20.86 in

2.73 kg / 6.01 lb.  
Apilable Stackable | Empilable

STD units	Packaging dim. (cm)	M3/ pack	NW units (kg)	Units Container 20'	Units Container 40'	Units Container HC	Units Truck 70m <sup>3</sup>	Units Truck 100m <sup>3</sup>
4	80x60x80	0,38	2,73	264	580	700	840	1000
Box Pallet (10)	80x60x120	0,58	2,73	260	550	1100	1340	1600

### JULIETA

Mesa monobloc para uso interior y exterior. Inyectada en polipropileno. Apilable. Protección UV. Box palet (15 unidades): 3 verde lima / 3 azul cielo / 3 rosa / 3 naranja / 3 roja.

Monobloc table for indoor and outdoor use. Injected with polypropylene. Stackable. UV Protection. Box pallet (15 units): 3 lime green / 3 light blue / 3 pink / 3 orange / 3 red.

Table monobloc d'intérieur et extérieur. Injectée en polypropylène. Empilable. Protection UV. Box palette (15 unités): 3 vert lime / 3 bleu ciel / 3 rose / 3 orange / 3 rouge.



- **00853** Rojo Red Rouge
- **00856** Naranja Orange Orange
- **00857** Azul Cielo Light Blue Bleu Ciel
- **00858** Rosa Pink Rose
- **00854** Verde Lima Lime Green Vert Lime

W 50 cm W 19.69 in  
L 50 cm L 19.69 in  
H 49 cm H 19.29 in

1.70 kg / 3.75 lb.  
Apilable Stackable | Empilable

STD units	Packaging dim. (cm)	M3/ pack	NW units (kg)	Units Container 20'	Units Container 40'	Units Container HC	Units Truck 70m <sup>3</sup>	Units Truck 100m <sup>3</sup>
4	61x61x62	0,23	1,70	324	684	912	1064	1240
80	120x60x213	1,53	1,70	880	2000	2000	2640	2880
Box Pallet (15)	80x60x120	0,58	1,70	390	825	1650	2010	2400

### RITA

Mesa monobloc para uso interior y exterior. Inyectada en polipropileno. Apilable. Protección UV. Box palet (15 unidades): 3 verde lima / 3 azul cielo / 3 rosa / 3 naranja / 3 roja.

Monobloc table for indoor and outdoor use. Injected with polypropylene. Stackable. UV protection. Box pallet (15 units): 3 lime green / 3 light blue / 3 pink / 3 orange / 3 red.

Table monobloc d'intérieur et extérieur. Injectée en polypropylène. Empilable. Protection UV. Box palette (15 unités): 3 vert lime / 3 bleu ciel / 3 rose / 3 orange / 3 rouge.



- **03715** Rojo Red Rouge
- **03716** Naranja Orange Orange
- **03718** Azul Cielo Light Blue Bleu Ciel
- **03719** Rosa Pink Rose
- **03717** Verde Lima Lime Green Vert Lime

Ø 50 cm Ø 19.69 in  
H 49 cm H 19.29 in

1.85 kg / 4.08 lb.  
Apilable Stackable | Empilable

STD units	Packaging dim. (cm)	M3/ pack	NW units (kg)	Units Container 20'	Units Container 40'	Units Container HC	Units Truck 70m <sup>3</sup>	Units Truck 100m <sup>3</sup>
4	61x61x62	0,23	1,82	324	684	912	1064	1240
80	120x60x213	1,53	1,82	880	2000	2000	2640	2880
Box Pallet (15)	80x60x120	0,58	1,82	390	825	1650	2010	2400

W: ancho / width / largeur. L: largo / length / longueur. H: altura / height / hauteur. Hs: altura asiento / seat height / hauteur du siège. Ha: altura brazo / arm height / hauteur du bras. Ø: diámetro / diameter / diamètre.

## SET CLICK CLACK

Set de polipropileno inyectado para uso interior y exterior compuesto por 1 sofá doble, 2 sillones, 1 mesa y 3 cojines. Óptimo packaging.

Set of injected polypropylene for indoor and outdoor use composed of 1 double sofa, 2 armchairs, 1 table and 3 cushions. Optimal packaging.

Set injectée en polypropylène pour usage intérieur et extérieur composé par 1 double canapé, 2 fauteuils, 1 table et 3 coussins. Packaging optimal.



Mesa   Table   Table				Sillón   Armchair   Fauteuil				Sofá   Sofa   Canapé			
W 45 cm	W 17.72 in	L 90 cm	L 35.43 in	W 74 cm	W 29.13 in	L 64,50 cm	L 25.39 in	W 124 cm	W 48.82 in	L 64,50 cm	L 25.39 in
H 45 cm	H 17.72 in			H 72,50 cm	H 28.54 in	SH 42 cm	SH 16.54 in	H 72,50 cm	H 28.54 in	SH 42 cm	SH 16.54 in

STD units	Packaging dim. (cm)	M3/ pack	NW units (kg)	Units Container 20'	Units Container 40'	Units Container HC	Units Truck 70m³	Units Truck 100m³
1	120x80x55	0,5	43	44	100	100	132	200



43 kg. / 94.82 lb.

## SET SIESTA

Set compuesto por dos sillones, un sofá y una mesa de centro fabricados en ratán sintético. Estructura de aluminio pintado por pulverización al horno. Óptimo packaging. Incluye cojines. Mesa con sobre de cristal.

Set composed by two armchairs, a double sofa and a coffee table made in synthetic rattan. Powder-coated aluminium structure. Transparent glass table top. Optimal packaging. Cushions included.

Set composé par deux fauteuils, un canapé deux places et une table basse fabriqués en rattan synthétique. Structure aluminium peinte par pulvérisation au four. Tableau en verre transparent. Packaging optimal. Coussins inclus.



Sofá   Sofa   Canapé				Sillón   Armchair   Fauteuil				Mesa   Table   Table			
W 150 cm	W 59.05 in	L 67 cm	L 26.37 in	W 79 cm	W 3.10 in	L 67 cm	L 26.37 in	W 84 cm	W 33.07 in	L 60 cm	L 23.62 in
H 85 cm	H 33.46 in			H 85 cm	H 33.46 in			H 40,5 cm	H 15.94 in		

STD units	Packaging dim. (cm)	M3/ pack	NW units (kg)	Units Container 20'	Units Container 40'	Units Container HC	Units Truck 70m³	Units Truck 100m³
1	144x74x72	0,77	30,7	24	48	48	54	66

30.7kg / 67.68 lb.

## SET BAHIA

Set compuesto por dos sillones y una mesa de centro fabricados en resina muy resistente y duradera reforzada con fibra de vidrio. Protección UV. Óptimo packaging.

Set composed by two armchairs and a coffee table made by very strong and durable resin reinforced with fiberglass. UV protection. Optimal packaging.

Set composé par deux fauteuils et une table basse fabriqués résine très solide et durable renforcé avec fibre de verre. Protection UV. Packaging optimal.



Sillón   Armchair   Fauteuil				Mesa   Table   Table			
W 58 cm	W 22.83 in	L 64 cm	L 25.20 in	W 45 cm	W 17.72 in	L 45 cm	L 17.72 in
H 80 cm	H 31.50 in			H 45 cm	H 17.72 in		

STD units	Packaging dim. (cm)	M3/ pack	NW units (kg)	Units Container 20'	Units Container 40'	Units Container HC	Units Truck 70m³	Units Truck 100m³
1	66,1x60,1x90	0,36	11,2	66	152	180	240	272

11.20kg. / 24.69 lb

W: ancho / width / largeur. L: largo / length / longueur. H: altura / height / hauteur. Hs: altura asiento / seat height / hauteur du siège. Ha: altura brazo / arm height / hauteur du bras. Ø: diámetro / diameter / diamètre.

## ACQUA

Tumbona para uso doméstico apilable. Estructura de polipropileno y fibra de vidrio en color blanco. Textilene termosoldado para mayor resistencia, y trama y urdimbre de doble hilo. Protección UV. Ruedas en patas traseras y tacos antideslizantes en las delanteras y traseras. Incorpora posavasos. Reclinable en 4 posiciones.

Stackable sunlounger for domestic use. Polypropylene and fiberglass white frame. Textilene thermowelded to improve resistance, double linen weft and warp. UV Protection. Wheels under back legs and non-slip end-plates under front and back legs. Glass holder. Four-position reclining sunlounger.

Chaise longue pour usage domestique, empilable, avec structure en polypropylène et fibre de verre en couleur blanc. Textilène termosoudé pour une meilleure résistance et double chaîne et du fil de trame et ourdir. Pieds arrière munis de roues et pieds avant et arrière munis de patins antidérapants, avec repose-verres. 4 positions du dossier.



W 73 cm	W 28.74 in	10.6 kg / 23.37 lb.
L 190 cm	L 74.80 in	Apilable Stackable   Empilable
H 35 cm	H 13.78 in	

STD units	Packaging dim. (cm)	M3/ pack	NW units (kg)	Units Container 20'	Units Container 40'	Units Container HC	Units Truck 70m³	Units Truck 100m³
2	195x75x50	0,73	10,60	72	144	180	200	240
25	193x75x225	3,26	10,60	225	450	450	525	600

## MASTER

Tumbona apilable con estructura de polipropileno. Con alojamiento posavasos o móvil en el lado derecho y caja de seguridad en el lado izquierdo con tapa y candado opcional. Ruedas en patas traseras. Respaldo reclinable en 5 posiciones. Protección UV.

Polypropylene frame stackable sunlounger. With space to hold drinking glasses or to store a mobile phone on the right side, and safety box on the left side with optional cover and lock. Wheels under back legs. Five-position reclining sunlounger. UV Protection.

Chaise longue empilable avec structure en PP. Avec compartiment pose-verre ou portable sur le côté droit et caisson de sécurité sur le côté gauche équipé d'un couvercle avec cadenas en option. Munie de roues arrière. Dossier réglable avec 5 positions. Protection UV.



- 04517 tapa + candado | cover + lock | couvercle + cadenas
- 03211 tapa + candado | cover + lock | couvercle + cadenas
- 03210 tapa + candado | cover + lock | couvercle + cadenas

W 63 cm	W 24.80 in	10.25 kg / 22.55 lb
L 188 cm	L 74.02 in	Apilable Stackable   Empilable
H 47 cm	H 18.50 in	

STD units	Packaging dim. (cm)	M3/ pack	NW units (kg)	Units Container 20'	Units Container 40'	Units Container HC	Units Truck 70m³	Units Truck 100m³
2	195x75x50	0,73	10,25	72	144	180	200	240
33	185x70x221	2,86	10,25	297	627	627	693	825

W: ancho / width / largeur. L: largo / length / longueur. H: altura / height / hauteur. Hs: altura asiento / seat height / hauteur du siège. Ha: altura brazo / arm height / hauteur du bras. Ø: diámetro / diameter / diamètre.



## ESPECIFICACIONES TÉCNICAS

TECHNICAL SHEET | SPÉCIFICATIONS TECHNIQUES

### COSTA BRAVA

Tumbona apilable fija con estructura de polipropileno. Con alojamiento para vasos y/o móvil en el lado derecho. Ruedas en patas traseras.

Stackable sunlounger. Polypropylene frame. Glass holder or a place to store a mobile phone on the right side. Wheels under back legs.

Chaise longue fixe et empilable avec structure en PP. Avec compartiment pose-verre et/ou portable sur le côté droit. Munie de roues arrière.



04568 Antracita Anthracite  
00124 Blanco White Blanc

W 63 cm W 24.80 in  
L 188 cm L 74.02 in  
H 47 cm H 18.50 in

8.65 kg / 19.07 lb.

Apilable Stackable | Empilable

STD units	Packaging dim. (cm)	M3/ pack	NW units (kg)	Units Container 20'	Units Container 40'	Units Container HC	Units Truck 70m³	Units Truck 100m³
2	195x75x50	0,73	8,65	72	144	180	200	240
33	185x70x221	2,86	8,65	297	627	627	693	825

### PALAMOS

Tumbona multiposiciones con brazos plegable inyectada en polipropileno. 3 posiciones. Con ruedas. Protección UV. orange / 10 rouge.

Multi-position folding sunlounger with arms, injected in polypropylene. 3 positions. With wheels. UV protection.

Chaise longue pliante avec bras, injectée en polypropylène. 3 positions. Avec roues. Protection UV.



00116 Blanco White Blanc

W 63 cm W 24.80 in  
L 183 cm L 72.05 in  
H 49 cm H 19.29 in

11.32 kg / 24.96 lb.

STD units	Packaging dim. (cm)	M3/ pack	NW units (kg)	Units Container 20'	Units Container 40'	Units Container HC	Units Truck 70m³	Units Truck 100m³
1	68x36x85	0,21	11,32	143	294	332	402	483
12	140x90x215	2,71	11,32	120	252	252	288	336

### IBIZA

Tumbona multiposiciones con brazos plegable inyectada en polipropileno. 5 posiciones. Con ruedas. Protección UV.

Multi-position folding sunlounger with arms, injected in polypropylene. 5 positions. With wheels. UV protection.

Chaise longue pliante avec bras, injectée en polypropylène. 5 positions. Avec roues. Protection UV.



01471 Blanco White Blanc

W 65 cm W 25.59 in  
L 190 cm L 74.80 in  
H 49 cm H 19.29 in

10.6 kg / 23.37 lb.

STD units	Packaging dim. (cm)	M3/ pack	NW units (kg)	Units Container 20'	Units Container 40'	Units Container HC	Units Truck 70m³	Units Truck 100m³
18	140x110x225	3,47	10,60	144	288	288	324	378

## ESPECIFICACIONES TÉCNICAS

TECHNICAL SHEET | SPÉCIFICATIONS TECHNIQUES

### MONACO

Mesa auxiliar monobloc de polipropileno. Protección UV. Apilable.

Polypropylene monobloc side table. UV protection. Stackable.

Table auxiliaire monobloc en polypropylène avec. Protection UV. Empilable.



04206 Antracita Anthracite  
00931 Blanco White Blanc

W 50 cm W 19.69 in  
L 50 cm L 19.69 in  
H 45 cm H 17.72 in

1.65 kg / 3.63 lb.

Apilable Stackable | Empilable

STD units	Packaging dim. (cm)	M3/ pack	NW units (kg)	Units Container 20'	Units Container 40'	Units Container HC	Units Truck 70m³	Units Truck 100m³
5	61x61x62	0,23	1,60	405	855	1140	1330	1550
16	120x80x120	1,15	1,60	726	1650	3300	4356	5280
82	120x80x220	2,11	1,60	2370	5400	5400	7128	8640

### ANDORRA

Mesa auxiliar de polipropileno. Protección UV. Patas ajustadas a presión.

Polypropylene side table. UV Protection. Pressure-fitted legs.

Table auxiliaire en polypropylène. Protection UV. Pieds emboîtés à pression.



04032 Antracita Anthracite  
00110 Blanco White Blanc

W 47 cm W 18.50 in  
L 47 cm L 18.50 in  
H 41 cm H 16.14 in

2.14 kg / 4.71 lb.

STD units	Packaging dim. (cm)	M3/ pack	NW units (kg)	Units Container 20'	Units Container 40'	Units Container HC	Units Truck 70m³	Units Truck 100m³
6	52x48x48	0,12	2,14	1152	2400	3000	3984	4800
120	120x100x215	2,58	2,14	960	2400	2400	2640	3120
136	120x100x235	2,82	2,14	1088	2720	2720	2992	3536

### ROSES

Carro plegable inyectado con polipropileno.

Folding trolley injected in polypropylene.

Chariot pliant injecté en polypropylène.



00148 Blanco White Blanc

W 53 cm W 20.87 in  
L 79 cm L 31.10 in  
H 72 cm H 28.35 in

5.1 kg / 11.24 lb.

STD units	Packaging dim. (cm)	M3/ pack	NW units (kg)	Units Container 20'	Units Container 40'	Units Container HC	Units Truck 70m³	Units Truck 100m³
1	96x53x16	0,08	5,10	336	672	768	840	1216



## Mesa Bini

Mesa Bini para uso interior y exterior. Fabricada en polipropileno con fibra de vidrio, con protección UV.

Peso 7,34 kg

Dimensiones: Ø70 x H74 / Hb71,1 cm

### Cotas mesa

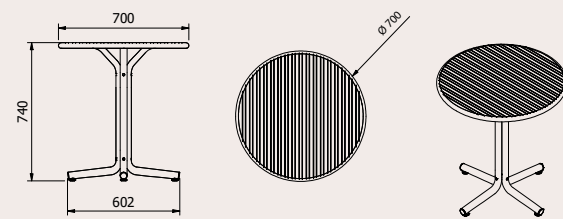

#### Embalaje / caja - Mesa Bini

STD salida	Volumen Pack (m³)	Units Container 20'	Units Container 40'	Units Container 40HC	Units Truck 70m³	Units Truck 100m³
1X	0,062	450	912	1056	1254	1360



## Mesa Bini Lounge

Mesa Bini Lounge para uso interior y exterior. Fabricado en polipropileno con fibra de vidrio, con protección UV.

Peso 5,5 kg

Dimensiones: Ø70 x H40,4 / Hb37,4 cm

### Cotas mesa lounge

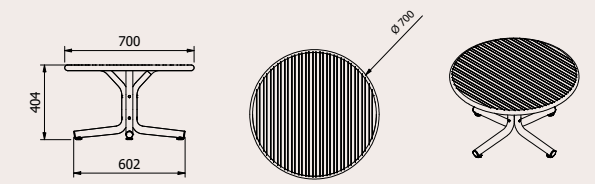

#### Embalaje / caja - Mesa Bini Lounge

STD salida	Volumen Pack (m³)	Units Container 20'	Units Container 40'	Units Container 40HC	Units Truck 70m³	Units Truck 100m³
1X	0,062	450	912	1056	1254	1360

## Colores

	Gris Oscuro   Dark Grey   Gris Foncé	Pantone 425C	RAL 7024
	Gris Verdoso   Green-grey   Gris Vert	Pantone 7538C	RAL 7033
	Marfil   Ivory   Ivoire		RAL 1013
	Terra cota   Terracota   Terracotta	Pantone 16-1526 TPX	RAL 3014
	Toscana   Tuscan   Toscane	Pantone 7556 C	RAL 085 60 60
	Arena   Sand   Sable	Pantone 7530C	RAL 1019



Codificación artículo de venta

## Silla Bini y Sillón Bini Lounge

SILLA BINI COLOR	2X	4X	P24
SILLA BINI GRIS OSCURO	05376.2X	05376.4X	05376.P24
SILLA BINI GRIS VERDOSO	05377.2X	05377.4X	05377.P24
SILLA BINI MARFIL	05378.2X	05378.4X	05378.P24
SILLA BINI TERRACOTTA	05379.2X	05379.4X	05379.P24
SILLA BINI TOSCANO	05380.2X	05380.4X	05380.P24
SILLA BINI ARENA	05381.2X	05381.4X	05381.P24

## Sillón Lounge Bini

SILLÓN BINI LOUNGE COLOR	2X	4X	P22
SILLÓN BINI LOUNGE GRIS OSCURO	05382.2X	05382.4X	05382.P22
SILLÓN BINI LOUNGE GRIS VERDOSO	05383.2X	05383.4X	05383.P22
SILLÓN BINI LOUNGE MARFIL	05384.2X	05384.4X	05384.P22
SILLÓN BINI LOUNGE TERRACOTTA	05385.2X	05385.4X	05385.P22
SILLÓN BINI LOUNGE TOSCANO	05386.2X	05386.4X	05386.P22
SILLÓN BINI LOUNGE ARENA	05387.2X	05387.4X	05387.P22

## Mesa Bini

MESA BINI COLOR	1X
MESA BINI GRIS OSCURO	05392.1X
MESA BINI GRIS VERDOSO	05393.1X
MESA BINI MARFIL	05394.1X
MESA BINI TERRACOTTA	05395.1X
MESA BINI TOSCANO	05396.1X
MESA BINI ARENA	05397.1X

## Mesa Bini Lounge

MESA BINI LOUNGE COLOR	1X
MESA BINI LOUNGE GRIS OSCURO	05398.1X
MESA BINI LOUNGE GRIS VERDOSO	05399.1X
MESA BINI LOUNGE MARFIL	05400.1X
MESA BINI LOUNGE TERRACOTTA	05401.1X
MESA BINI LOUNGE TOSCANO	05402.1X
MESA BINI LOUNGE ARENA	05403.1X



## MESAS PIE CENTRAL

### PEDESTAL BASE TABLES |

#### TABLES PIED CENTRAL

Renoir 40x40	251
Renoir ø40	251
Miró 40x40	252
Miró ø40	252
Tapies 40x40	253
Tapies ø40	253
Max	254
Neo	254
Ibiza S	255
Ibiza M	255

## MESAS PIE CENTRAL DOBLE

### PEDESTAL DOUBLE BASE TABLES |

#### TABLES PIED CENTRAL DOUBLE

Renoir Doble	256
Miró Doble	256
Tapies Doble	257
Max 120	257

## MESAS PIE CENTRAL ALTO

### HIGH PEDESTAL BASE TABLE |

#### TABLE PIED CENTRAL HAUTE

Renoir 110	258
Renoir 110 40x40	258
Miró 110	259

Miró 110 40x40	259
Tapies 110 ø40	260
Tapies 110	260
Max alto	260

## MESAS 4 PATAS

### 4 LEG TABLES | TABLES 4 PIEDS

Sky	266
Octopus 60	267
Ares 80	268
Ares 140	268
Bali	270
Tahiti	270
Orlando 80	271
Orlando 140	271
Mamba	272
Shio	272
Cubic	272
Wood New Flash	273
Alegria	274
Montblanc	274
Ripoll	274
Kibo	275
Naxos	275
Paros	275
Berlin	276
Zurich	276
Marsella	277

London	277
Malta	280
Core	280
Raya	282
Raya 2	282
Raya 3	282
Ola	283
Ola 2	283
Ola 3	283
Beach Bar	284
Sky Lounge	284
Miami	286
Miami Auxiliar	286
Monaco mesa rattan	286
Octopus Bar	287
Esculapi	287
Banyoles	287

## COMBINACIONES PIES | PEDESTAL COMBINATIONS | COMBINAISONS DE PIEDS

	Renoir	Miró	Tapies	Max	Neo
Pie central Pedestal base Pied				●	●
Pie central 40x40 Pedestal base 40x40 Pied 40x40	●	●	●		
Pie central Ø40 Pedestal base Ø40 Pied Ø40	●	●	●		
Pie central alto High pedestal base Pied central haut				●	
Pie central alto 40x40 High pedestal base 40x40 Pied central haut 40x40	●	●	●		
Pie central alto Ø40 High pedestal base Ø40 Pied central haut Ø40	●	●	●		
Pie central doble base rectangular Double central rectangular base pedestal Pied central double base rectangulaire	●	●	●		
Pie central doble Double central pedestal Pied central double				●	

## RENOIR 40X40

Pie | Pedestal base | Pied



Pie central en acero inoxidable. Base 40x40. Para uso interior y exterior.

Pedestal base in stainless steel. Base of 40x40. For outdoor and indoor use.

Pied central en acier inoxydable. Base de 40x40 cm. Pour usage intérieur et extérieur.

● Inox | Inox | Inox

W 40 cm | W 15.75 in  
L 40 cm | L 15.75 in  
H 73 cm | H 28.74 in

STD units	Packaging dim. (cm)	M3/pack	NW units (kg)	Units Container 20'	Units Container 40'	Units Container HC	Units Truck 70m³	Units Truck 100m³
1	42x42x73 + 11x11x73	0,06	20	466	933	1.100	1.133	1.633

## RENOIR Ø40

Pie | Pedestal base | Pied



Pie central en acero inoxidable. Base de Ø39 cm. Tubo de aluminio anodizado de Ø 60 mm con muesca antigiro. Altura 73 cm. Peso 7,80 kg. (Consultar tabla de combinaciones de pies y sobres en pág. 264). Para uso interior y exterior.

Pedestal base in stainless steel. Base of Ø39 cm. Ø60 mm anodized aluminium tube with non-turn notch. Height 73 cm. Weight 7.80 kg. (17.20 lb). (See combinations table for bases and table tops on p. 264). For outdoor and indoor use.

Pied central en acier inoxydable. Base de Ø 39 cm. Tube en aluminium anodisé en Ø60 mm avec encoche de fixation. Hauteur 73 cm. Poids 7,80 kg. (Voir le table combinaisons pour pieds et plateaux pag. 264). Pour usage intérieur et extérieur.

● Inox | Inox | Inox

Ø 39 cm | Ø 15.35 in  
H 73 cm | H 28.74 in

W: ancho / width / largeur. L: largo / length / longueur  
H: altura / height / hauteur. Hs: altura asiento / seat height / hauteur du siège. Ha: altura brazo / arm height / hauteur du bras  
Ø: diámetro / diameter / diamètre.

STD units	Packaging dim. (cm)	M3/pack	NW units (kg)	Units Container 20'	Units Container 40'	Units Container HC	Units Truck 70m³	Units Truck 100m³
1	42x42x7 + 11x11x73	0,06	16	466	933	1.100	1.133	1.633



## MIRÓ 40X40

Pie | Pedestal base | Pied



○ Blanco | White | Blanc

● Aluminio | Aluminio | Aluminio

W 40 cm	W 15.75 in
L 40 cm	L 15.75 in
H 73,5 cm	H 28.94 in

STD units	Packaging dim. (cm)	M3/ pack	NW units (kg)	Units Container 20'	Units Container 40'	Units Container HC	Units Truck 70m³	Units Truck 100m³
1	42x42x7	0,06	18	466	933	1.100	1.133	1.633
	+ 11x11x73							

Pie central para mesa de interior y exterior. Base de 40 x 40 cm en aluminio anodizado mate. Tubo de 80 x 80 mm de aluminio anodizado mate con muesca antigiro. Altura de 73,50 cm. Peso 11 kg. Con niveladores. (Consultar tabla de combinaciones de pies y sobres en pág. 264).

Pedestal base for indoor and outdoor table. Base of 40 x 40 cm in matt anodized aluminium. 80 x 80 mm matt anodized aluminium tube with non-turn notch. Height 73,50 cm. Weight 11 kg (24.25 lb). With levellers. (See combinations table for bases and table tops on p. 264).

Pied central pour table d'intérieur et d'extérieur. Base de 40 x 40 cm en aluminium anodisé mat. Tube de 80 x 80 mm en aluminium anodisé avec encoche de fixation. Hauteur 73,50 cm. Poids 11 kg. Avec niveleurs. (Voir le table combinaisons pour pieds et plateaux pag. 264)

## MIRÓ Ø40

Pie | Pedestal base | Pied



● Aluminio | Aluminio | Aluminio

ø 39 cm	ø 15.35 in
H 73,50 cm	H 28.94 in

STD units	Packaging dim. (cm)	M3/ pack	NW units (kg)	Units Container 20'	Units Container 40'	Units Container HC	Units Truck 70m³	Units Truck 100m³
1	42x42x7	0,06	15	466	933	1.100	1.133	1.633
	+ 11x11x73							

Pie central para mesa de interior y exterior. Base de Ø39 cm en aluminio anodizado mate. Tubo de ø60 mm en aluminio anodizado mate con muesca antigiro. Altura de 73,50 cm. Peso 8,50 kg. Con niveladores. (Consultar tabla de combinaciones de pies y sobres en pág. 264).

Pedestal base for indoor and outdoor table. Base of Ø39 cm in matt anodized aluminium. Ø60 mm matt anodized aluminium tube with non-turn notch. Height 73.50 cm. Weight 8.50 kg. (18.74 lb). With levellers. (See combinations table for bases and table tops on p. 264).

Pied central pour table d'intérieur et extérieur. Base de Ø39 cm en aluminium anodisé mat. Tube de ø 60 mm en aluminium anodisé mat avec encoche de fixation. Hauteur 73,50 cm. Poids 8,50 kg. Avec niveleurs. (Voir le table combinaisons pour pieds et plateaux pag. 264).

## TÀPIES 40X40

Pie | Pedestal base | Pied



Pie central de hierro fundido pintado en color negro, para mesa de uso interior. Columna de 80 x 80 mm con muesca antigiro. Base de 40 x 40 cm. Peso neto 20 kg. (Consultar tabla de combinaciones de pies y sobres en pág. 264).

Painted cast iron pedestal base table in black, for indoor use. 80 x 80 mm tube. Non-turn notch. Base of 40 x 40 cm. Net weight 20 kg (8.7 lb). (See Table combination for pedestral bases and table tops on p. 264).

Pied guéridon en font de fer peint en noir, pour table intérieur. Tube de 80x 80 mm avec encoche de fixation. Base de 40 x 40 cm. Poids net 20 Kg. (Voir le tableau de combinaison pour pieds central et planches pag. 264).

L 40 cm	L 15.75 in
W 40 cm	W 15.75 in
H 71 cm	H 27.95 in

○ Blanco | White | Blanc

● Negro | Black | Noir

STD units	Packaging dim. (cm)	M3/ pack	NW units (kg)	Units Container 20'	Units Container 40'	Units Container HC	Units Truck 70m <sup>3</sup>	Units Truck 100m <sup>3</sup>
1	42x42x7	0,06	20	466	933	1.100	1.133	1.633
	+ 11x11x73							

## TAPIES Ø40

Pie | Pedestal base | Pied



Pie central de hierro fundido pintado en color negro o blanco. Base de Ø40 cm. Mesa de uso interior (Consultar tabla de combinaciones 265).

Painted cast iron pedestal base table in black or in white. Base of Ø40 cm. For indoor use. (See table combination for pedestral bases and table tops on p. 265).

Pied central en fer fondu peint de couleur noire ou blanche. Base de Ø40 cm. Table pour usage intérieur. (Consultez le tableau de combinaisons de pieds et plateau en page 265).

Ø 40 cm	Ø 15.75 in
H 70 cm	H 27.55 in

○ Blanco | White | Blanc

● Negro | Black | Noir

STD units	Packaging dim. (cm)	M3/ pack	NW units (kg)	Units Container 20'	Units Container 40'	Units Container HC	Units Truck 70m <sup>3</sup>	Units Truck 100m <sup>3</sup>
1	41,5x41,5x4,5	0,01	9,7	1.818	2.136	2.136	-	-
	+ 73x8,5x8,5							

# MAX

Pie | Pedestal base | Pied



Pie central para mesa de interior y exterior, en fundición de aluminio pintado brillante o mate. Tubo de aluminio anodizado  $\varnothing$  60 x 2 mm de grosor, con muesca anti-giro. Contrapeso de acero de 4,50 kg. Con reguladores en las 4 patas. (Consultar tabla de combinaciones de pies y sobres en pág. 265).

Pedestal base for indoor and outdoor table. Cast aluminium. Shiny or matt painted finish. Anodized aluminium tube,  $\varnothing$  60 x 2 mm thick. Non-turn notch. Steel counterweight 4.5 kg (9.90 lb). With regulators in all 4 legs. (See Table combination for pedestral bases and table tops on p. 265).

Pied central pour table, intérieur ou extérieur, en fonte en aluminium peint brillant ou mat. Tube en aluminium anodisé  $\varnothing$  60 x 2 mm de grosueur. Encoche antigiratoire. Contrepoids en acier de 4,50 kg. Avec régulateurs aux 4 pieds (Voir le tableau de combinaison pour pieds central et planches pag. 265).

Atención: No recomendamos la versión en acabado brillante para ambientes salinos | Attention: Shiny painted finish version not recommended for saline environments | Attention: Nous ne recommandons pas la version brillante pour les environnements salins.

● Brillante | Shiny | Brillant

● Mate | Matt | Mat

W 53 cm | W 20.87 in  
L 53 cm | L 20.87 in  
H 71 cm | H 27.95 in

STD units	Packaging dim. (cm)	M3/ pack	NW units (kg)	Units Container 20'	Units Container 40'	Units Container HC	Units Truck 70m <sup>3</sup>	Units Truck 100m <sup>3</sup>
1	54x54x10 + 10x10x73	0,03	8,2	850	1.700	-	-	-

# NEO

Pie | Pedestal base | Pied



Pie central para exterior. Estructura tubular de aluminio anodizado brillante. (Consultar tabla de combinaciones en la página 264)

Central pedestal for outdoor use. Tubular structure of anodized aluminium, shiny finish. (See Table combination p. 264)

Pied central pour extérieur. Structure tubulaire en aluminium anodisé brillant. (Voir couleurs pag. 264).

○ Blanco | White | Blanc

● Aluminio | Aluminio | Aluminium

W 68 cm | W 26.77 in  
L 68 cm | L 26.77 in  
H 71 cm | H 27.95 in

STD units	Packaging dim. (cm)	M3/ pack	NW units (kg)	Units Container 20'	Units Container 40'	Units Container HC	Units Truck 70m <sup>3</sup>	Units Truck 100m <sup>3</sup>
1	51x51x14 + 10x10x73	0,04	8,21	933	-	-	-	-

## IBIZA S

Pie | Pedestal | Pied



- Gris Oscuro | Dark Grey | Gris Foncé
- Chocolate | Chocolate | Chocolat

**Siesta**  
exclusive

W 58 cm | W 22.83 in  
L 58 cm | L 22.83 in  
H 72,5 cm | H 28.54 in

STD units	Packaging dim. (cm)	M3/ pack	NW units (kg)	Units Container 20'	Units Container 40'	Units Container HC	Units Truck 70m³	Units Truck 100m³
1	73x58x36	0,152	8,3	192	448	448	-	576

Estructura de ratán de 80 cm de longitud para combinarlo con tablero compacto de HPL. Para mesa tanto de uso interior como exterior. (Consultar la tabla de combinaciones en la página 265).

Rattan structure of 80 cm length to combine with HPL compact laminate tops. For indoor and outdoor use. (See Table combination p. 265).

Structure de rotin de 80 cm de longueur pour combiner avec le plateau compact en HPL. Pour table autant à usage intérieur qu'extérieur. (Consultez le tableau des combinaisons pag. 265).

## IBIZA M

Pie | Pedestal | Pied



- Gris Oscuro | Dark Grey | Gris Foncé
- Chocolate | Chocolate | Chocolat

**Siesta**  
exclusive

W 118 cm | W 46.46 in  
L 58 cm | L 22.83 in  
H 72,5 cm | H 28.54 in

STD units	Packaging dim. (cm)	M3/ pack	NW units (kg)	Units Container 20'	Units Container 40'	Units Container HC	Units Truck 70m³	Units Truck 100m³
1	73x58x36	0,15	10,3	192	448	448	-	576

Estructura de ratán de 140 cm de longitud para combinarlo con tablero compacto de HPL. Para mesa tanto de uso interior como exterior. (Consultar la tabla de combinaciones en la página 265).

Rattan structure of 140 cm length to combine with HPL compact laminate tops. For indoor and outdoor use.. (See Table combination p. 265).

Structure de rotin de 140 cm de longueur pour combiner avec le plateau compact en HPL. Pour table autant à usage intérieur qu'extérieur. (Consultez le tableau des combinaisons pag. 265).



## RENOIR DOBLE

Pie | Pedestal base | Pied



Pie central doble en acero inoxidable. Base de 72 x 40 cm. Tubos de aluminio anodizado de 80 x 80 mm con muesca antigiro. Altura de 73 cm. Peso 19,50 kg. (Consultar tabla de combinaciones de pies y sobres en pág. 264). Para uso interior y exterior.

Double pedestal in stainless steel. Base of 72 x 40 cm. 80 x 80 mm anodized aluminium tube with non-turn notch. Height 73 cm. Weight 19,50 kg (42.99 lb). (See Combinations table for bases and table tops on p.264). For outdoor and indoor use.

Double pied central en acier inoxydable. Base de 72 x 40 cm. Tube en aluminium anodisé de 80 x 80 mm avec encoche de fixation. Pour usage intérieur et extérieur. Hauteur 73 cm. Poids 19,50 kg. (Voir le tableau de combinaison pour pieds et plateaux pag. 264). Pour usage intérieur et extérieur.

● Inox | Inox | Inox

W 70 cm | W 27.56 in  
L 40 cm | L 15.75 in  
H 73 cm | H 28.74 in

STD units	Packaging dim. (cm)	M3/ pack	NW units (kg)	Units Container 20'	Units Container 40'	Units Container HC	Units Truck 70m <sup>3</sup>	Units Truck 100m <sup>3</sup>
1	42x84x7	0,06	32	466	933	1.100	1.133	1.633
+ 11x11x73 (2)								

## MIRÓ DOBLE

Pie | Pedestal base | Pied

● Aluminio | Aluminio | Aluminio

W 40 cm | W 15.75 in  
L 40 cm | L 15.75 in  
H 73,5 cm | H 28.94 in



Pie central doble para mesa de interior y exterior. Base de 72x40cm en aluminio anodizado mate. Tubo de 80 x 80 mm en aluminio anodizado mate con muesca antigiro. Altura de 73,50 cm. Peso 20kg. Con niveladores. (Consultar tabla de combinaciones de pies y sobres en pág. 264).

Double pedestal base for indoor and outdoor table. Base of 72 x 40 cm in matt anodized aluminium. 80 x 80 mm matt anodized aluminium tube with non-turn notch. Height 73,50 cm. Weight 20 kg (44.09 lb). With levellers. (See combinations table for bases and table tops on p. 264).

Double pied central pour table d'intérieur et d'extérieur. Base de 72 x 40 cm en aluminium anodisé mat. Tube de 80 x 80 mm en aluminium anodisé mat avec encoche de fixation. Hauteur 73,50 cm. Poids 20 kg. Avec niveleurs. (Voir le tableau de combinaisons pour pieds et plateaux pag. 264).

W: ancho / width / largeur. L: largo / length / longueur  
H: altura / height / hauteur. Hs: altura asiento / seat height / hauteur du siège. Ha: altura brazo / arm height / hauteur du bras  
Ø: diámetro / diameter / diamètre.

STD units	Packaging dim. (cm)	M3/ pack	NW units (kg)	Units Container 20'	Units Container 40'	Units Container HC	Units Truck 70m <sup>3</sup>	Units Truck 100m <sup>3</sup>
1	42x84x7	0,06	18	466	933	1.100	1.133	1.633
+ 22x11x73 (2)								



# TÀPIES DOBLE

Pie | Pedestal base | Pied



Pie central de hierro fundido pintado en color negro o blanco. Mesa de uso interior (Consultar tabla de combinaciones 264)

Painted cast iron pedestal base table in black or in white. For indoor use. (See table combination for pedestral bases and table tops on p.264)

Pied central en fer fondu peint de couleur noire ou blanche. Table pour usage intérieur. (Consultez le tableau de combinaisons de pieds et plateau en page 264).

○ Blanco | White | Blanc

● Negro | Black | Noir

L 70 cm	L 27.55 in
W 40 cm	W 15.75 in
H 71 cm	H 27.95 in

STD units	Packaging dim. (cm)	M3/ pack	NW units (kg)	Units Container 20'	Units Container 40'	Units Container HC	Units Truck 70m³	Units Truck 100m³
1	71,5x41,5x4,5 +73x9,3x9,3 (2)	0,02	24,3	772	907	907	-	-

**W:** ancho / width / largeur. **L:** largo / length / longueur  
**H:** altura / height / hauteur. **Hs:** altura asiento / seat height / hauteur du siège. **Ha:** altura brazo / arm height / hauteur du bras  
**Ø:** diámetro / diameter / diamètre.

# MAX 120

Pie | Pedestal base | Pied



Pie central doble para mesa interior y exterior, en fundición de aluminio pintado brillante o mate. Tubo de aluminio anodizado de Ø 60 x 2 mm de grosor, con muesca anti-giro Contrapeso de acero: 4,50 kg. Con reguladores en las 4 patas. (Consultar tabla de combinaciones de pies y sobres en pág. 265).

Double pedestal base table for indoor and outdoor use, in shiny or matt polished cast aluminium. Anodized aluminium tube of Ø 60 x 2 mm thickness. Non-turn notch. Steel counterweight: 4.5 kg (9.90 lb). With regulators in all 4 legs. (See Table combination for pedestral bases and table tops on p. 265).

Pied central pour table intérieur ou extérieur, en fonte en aluminium poli brillant ou mat. Tube en aluminium anodisé Ø 60 x 2 mm de grosseur. Encoche anti giratoire. Contrepoids en acier: 4,50 kg. Avec régulateurs aux 4 pieds. (Voir le tableau de combinaison pour pieds central et planches pag. 265).

● Brillante | Shiny | Brillant

● Mate | Matt | Mat

W 79 cm	W 31.10 in
L 43 cm	L 16.93 in
H 71 cm	H 27.95 in

STD units	Packaging dim. (cm)	M3/ pack	NW units (kg)	Units Container 20'	Units Container 40'	Units Container HC	Units Truck 70m³	Units Truck 100m³
1	80x62x11 + 10x10x73	0,54	10,8	516	1.032	-	-	-

## RENOIR 110

Pie | Pedestal base | Pied



Pie central alto en acero inoxidable. Base de  $\varnothing$  39 cm. Tubo de aluminio anodizado de  $\varnothing$  60 mm con muesca antigiro. Altura de 111 cm. Peso 8 kg. (Consultar tabla de combinaciones de pies y sobres en pág. 264). Para uso interior y exterior.

High pedestal base in stainless steel. Base of  $\varnothing$ 39 cm.  $\varnothing$ 60 mm anodized aluminium tube with non-turn notch. Height 111 cm. Weight 8 kg (17.64 lb). (See combinations table for bases and table tops on p. 264). For outdoor and indoor use.

Pied central haut en acier inoxydable. Base de tube de  $\varnothing$ 39 cm. Tube en aluminium anodisé de  $\varnothing$ 60mm avec encoche de fixation. Hauteur 111 cm. Poids 8 kg. (Voir le table combinaisons pour pieds et plateaux pag. 264). Pour usage intérieur et extérieur.

● Inox | Inox | Inox

$\varnothing$  39 cm |  $\varnothing$  15.35 in  
H 111 cm | H 43.70 in

STD units	Packaging dim. (cm)	M3/ pack	NW units (kg)	Units Container 20'	Units Container 40'	Units Container HC	Units Truck 70m <sup>3</sup>	Units Truck 100m <sup>3</sup>
1	42x42x7 + 10x10x110	0,06	20	466	933	1.100	1.133	1.633

## RENOIR 110 40X40

Pie | Pedestal base | Pied



Pie central alto en acero inoxidable. Base de 40x40 cm. Tubo de aluminio anodizado. Altura de 111cm. (Consultar tabla de combinaciones de pies y sobres en pág. 264). Para uso interior y exterior.

High pedestal base in stainless steel. Base of 40 x 40 cm. Anodized aluminium tube. Height 111 cm. See combinations table for bases and table tops on p. 264). For outdoor and indoor use.

Pied central haut en acier inoxydable. Base tube de 40 x 40 cm. Tube en aluminium anodisé. Hauteur 111 cm. (Voir le table combinaisons pour pieds et plateaux pag. 264) Pour usage intérieur et extérieur.

● Inox | Inox | Inox

W 40 cm |  $\varnothing$  15.75 in  
L 40 cm | L 15.75 in  
H 111 cm | H 43.70 in

STD units	Packaging dim. (cm)	M3/ pack	NW units (kg)	Units Container 20'	Units Container 40'	Units Container HC	Units Truck 70m <sup>3</sup>	Units Truck 100m <sup>3</sup>
1	42x42x7 + 10x10x110	0,06	20	466	933	1.100	1.133	1.633

W: ancho / width / largeur. L: largo / length / longueur

H: altura / height / hauteur. Hs: altura asiento / seat height / hauteur du siège. Ha: altura brazo / arm height / hauteur du bras

$\varnothing$ : diámetro / diameter / diamètre.

## MIRÓ 110

Pie | Pedestal base | Pied



Pie central alto para interior y exterior en aluminio anodizado mate con muestra antigiro. Peso 18kg. Con niveladores. Consultar tabla de combinaciones de pies y sobres en pág. 264)

High pedestal base for indoor and outdoor made of anodized aluminium with non-torch notch. Weight 18kg. With levellers. (See combinations table for bases and table tops on p. 264)

Pied central haut por intérieur et extérieur en aluminium anodisé mat avec encoche de fixation. Poids 18kg. Avec niveleurs. (Voir le table combinaciones pour pieds et plateaux pag. 264)

● Aluminio | Aluminio | Aluminio

∅ 39 cm | ∅ 111.50 in  
H 15,35 cm | H 43.89 in

STD units	Packaging dim. (cm)	M3/ pack	NW units (kg)	Units Container 20'	Units Container 40'	Units Container HC	Units Truck 70m³	Units Truck 100m³
1	42x42x7	0,06	18	466	933	1.100	1.133	1.633
+ 110x10x110								

## MIRÓ 110 40X40

Pie | Pedestal base | Pied



Pie central para mesa de interior y exterior. Base de 40x40 cm en aluminio anodizado mate. Altura 110 cm. Con niveladores. (Consultar tabla de combinaciones de pies y sobres en pág. 264)

Pedestal base for indoor and outdoor table. Base of 40x40 cm in matt anodized aluminium. Height 110 cm. With levellers. (See combinations table for bases and table tops on p. 264)

Pied central pour table d'intérieur et d'extérieur. Base de 40x40 cm en aluminium anodisé mat. Hauteur 110 cm. Avec niveleurs. (Voir le table combinaisons pour pieds et plateaux pag. 264)

○ Blanco | White | Blanc

● Inox | Inox | Inox

W 40 cm | W 15.75 in  
L 40 cm | L 15.75 in  
H 110 cm | H 43.30 in

STD units	Packaging dim. (cm)	M3/ pack	NW units (kg)	Units Container 20'	Units Container 40'	Units Container HC	Units Truck 70m³	Units Truck 100m³
1	42x42x7	0,06	18	466	933	1.100	1.133	1.633
+ 110x10x110								

W: ancho / width / largeur. L: largo / length / longueur  
H: altura / height / hauteur. Hs: altura asiento / seat height / hauteur du siège. Ha: altura brazo / arm height / hauteur du bras  
∅: diámetro / diameter / diamètre.

## TAPIES 110 Ø40

Pie | Pedestal base | Pied



Pie central alto de hierro fundido pintado en color negro o blanco, para mesa de uso interior (Consultar tabla de combinaciones 265).

High iron pedestal base table in black or white. For indoor use. (See table combination for pedestral bases and table tops on p. 265).

Pied central haut en fer fondu peint de couleur noire ou blanche. Table pour usage intérieur. (Consultez le tableau de combinaisons de pieds et plateau en page 265).

- Blanco | White | Blanc
  - Negro | Black | Noir
- |          |            |
|----------|------------|
| ø 40 cm  | ø 15.75 in |
| H 106 cm | H 41.73 in |

STD units	Packaging dim. (cm)	M3/ pack	NW units (kg)	Units Container 20'	Units Container 40'	Units Container HC	Units Truck 70m³	Units Truck 100m³
1	41,5x41,5x4,5	0,016	11	1.626	1.910	1.910	-	-
	+ 109x8,5x8,5							

## TAPIES 110

Pie | Pedestal base | Pied



Pie central alto de hierro fundido pintado en color negro o blanco, para mesa de uso interior (Consultar tabla de combinaciones 265).

High iron pedestal base table in black or white. For indoor use. (See table combination for pedestral bases and table tops on p. 265).

Pied central haut en fer fondu peint de couleur noire ou blanche. Table pour usage intérieur. (Consultez le tableau de combinaisons de pieds et plateau en page 265).

- Blanco | White | Blanc
- Negro | Black | Noir

W: ancho / width / largeur. L: largo / length / longueur  
 H: altura / height / hauteur. Hs: altura asiento / seat height / hauteur du siège. Ha: altura brazo / arm height / hauteur du bras  
 Ø: diámetro / diameter / diamètre.

W 40 cm	W 15.75 in
L 40 cm	L 15.75 in
H 106 cm	H 41.73 in

STD units	Packaging dim. (cm)	M3/ pack	NW units (kg)	Units Container 20'	Units Container 40'	Units Container HC	Units Truck 70m³	Units Truck 100m³
1	41,5x41,5x4,5	0,017	13,9	1.315	1.546	1.546	-	-
	+ 109x9,3x9,3							

## MAX ALTO

Pie | Pedestal base | Pied



Pie central alto para mesa de interior y exterior, en fundición de aluminio brillante o pintado mate. Tubo de aluminio anodizado mate ø 60 x 2 mm de grosor, con muesca anti-giro. Contrapeso de acero: 4,50 kg. Con reguladores en las 4 patas. (Consultar tabla de combinaciones de pies y sobres en pág. 265).

Pedestal base for high table for indoor and outdoor use, in shiny cast aluminium or matt painted. Anodized aluminium tube, matt finish, ø 60 x 2 mm thickness, with non-turn notch. Steel counterweight: 4.5 kg (9.90 lb). With regulators in all 4 legs. (See Table combination for pedestral bases and table tops on p. 265).

Pied guéridon haut pour table, intérieur ou extérieur, en coulage en aluminium brillant ou peint mat. Tube en aluminium anodisé, ø 60 x 2 mm de grosseur. Encoche anti giratoire. Contrepoids en acier: 4,50 kg. Avec régulateurs aux 4 pieds. (Voir le tableau de combinaison pour pieds central et planches pag. 265).

W 53 cm	W 20.86 in
L 53 cm	L 20.86 in
H 109 cm	H 42.91 in

- Brillante | Shiny | Brillant
- Mate | Matt | Mat

STD units	Packaging dim. (cm)	M3/ pack	NW units (kg)	Units Container 20'	Units Container 40'	Units Container HC	Units Truck 70m³	Units Truck 100m³
1	53x53x9	0,02	8,7	750	1500	-	-	-
	8x8x110	+ 0,01						

# TABLERO COMPACTO FENÓLICO

## HPL TABLE TOP

### PLATEAU RÉSINE PHÉNOLIQUE

El compacto fenólico es un laminado de alta presión (HPL). Su composición consiste en capas de papel aglutinado con resinas termoestables de melamina-formaldehído en su superficie y de fenol-formaldehído en su interior. Todo ello es prensado a alta presión ( $\geq 7$  MPa) y alta temperatura ( $\geq 120^\circ\text{C}$ ), dando como resultado uno de los materiales más versátiles por su apariencia, estética, resistencia y durabilidad.

Su extraordinaria superficie está constituida por una hoja impregnada con resina de melamina-formaldehído, que es la que aporta el diseño. Por encima de este diseño decorativo lleva una hoja adicional (overlay), impregnada también en resina melamínica, que le aporta gran resistencia al rayado y la abrasión. Finalmente, el núcleo central, compuesto de papel kraft impregnado en resina fenólica, le dotan de gran resistencia al impacto. Tanto el overlay como el núcleo central de resina fenólica, son los dos elementos diferenciadores del laminado HPL.

El laminado HPL posee la cualidad de ser resistente al calor, al rayado, a la abrasión, impermeable e inerte debido a su superficie no porosa, lo cual lo hace apto para uso interior y exterior e ideal para uso contract.

HPL is a high pressure laminate (HPL). Its composition is bonded paper layers with thermosetting resins, melamine-formaldehyde on its surface and phenol-formaldehyde inside. All this is pressed at high pressure ( $\geq 7$  MPa) and high temperature ( $\geq 120^\circ\text{C}$ ), resulting in one of the most versatile materials in appearance, aesthetics, strength and durability.

Its extraordinary surface is constituted by a sheet impregnated with melamine-formaldehyde resin, which gives it a unique design. Above this decorative design it has an additional sheet (overlay) that's also impregnated with melamine resin, which makes it highly resistant to scratches and abrasion. Finally, the central core, consisting of kraft paper impregnated with phenolic resin, provide it with high impact resistance. Both the overlay and the core of phenolic resin are the two distinguishing features of HPL.

The HPL has the peculiarity of being resistant to heat, scratch, abrasion, waterproof and inert due to its non-porous surface, making it suitable for indoor and outdoor use and ideal for contract use.

La résine phénolique est un stratifié compact (HPL) de haute pression. Sa composition est constituée de couches de papier avec des résines thermodurcissables, des résines mélamine-formaldéhyde, sur sa surface et de phénol-formaldéhyde à l'intérieur. Tout cela est pressé à haute pression ( $\geq 7$  MPa) et haute température ( $\geq 120^\circ\text{C}$ ), résultant un des matériaux les plus polyvalents pour son apparence, esthétique, solidité et durabilité.

Sa surface extraordinaire est constituée par une feuille imprégnée de résine mélamine-formaldéhyde, qui elle même apporte son dessin. Au-dessus de ce dessin décoratif, s'ajoute une feuille supplémentaire (overlay) imprégnée de résine mélamine également, ce qui donne une haute résistance les rayures et l'abrasion. Enfin, le noyau central, composé de papier kraft imprégné de résine phénolique, lui permet une résistance aux chocs élevée. Autant la superposition comme le noyau de résine phénolique sont les deux traits distinctifs de HPL.

Le HPL a la qualité d'être résistant à la chaleur, aux égratignures, à l'abrasion, imperméable à l'eau et inerte en raison de sa surface non poreuse, ce qui convient pour usage intérieur et extérieur et idéal pour une utilisation contrat.



Blanco | White | Blanc



Negro | Black | Noir

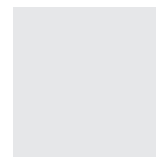

Plata | Silver | Argent

Ø 60 cm H 1 cm	Ø 23.62 in H 0.40 in	Ø 70 cm H 1 cm	Ø 27.56 in H 0.40 in
Ø 80 cm H 77,7 cm	Ø 31.49 in H 0.40 in	L 60 cm W 60 cm H 1 cm	L 23.62 in W 23.62 in H 0.40 in
L 70 cm W 70 cm H 1 cm	L 27.56 in W 27.56 in H 0.40 in	L 80 cm W 80 cm H 1 cm	L 31.49 in W 31.49 in H 0.40 in
L 90 cm W 90 cm H 1 cm	L 35.43 in W 35.43 in H 0.40 in	L 120 cm W 80 cm H 1 cm	L 47.24 in W 31.49 in H 0.40 in
L 180 cm W 90 cm H 1 cm	L 70.87 in W 35.43 in H 0.40 in	L 200 cm W 90 cm H 1 cm	L 78.74 in W 35.43 in H 0.40 in



Madera lavada | Washed Wood | Bois Delavé



Roble Ceniza | Ashen Oak | Chêne Cendré



Roble Natural | Natural Oak | Chêne Naturel

L 70 cm W 60 cm H 1 cm	L 27.56 in W 23.62 in H 0.40 in	L 70 cm W 70 cm H 1 cm	L 27.56 in W 27.56 in H 0.40 in
L 80 cm W 80 cm H 1 cm	L 31.49 in W 31.49 in H 0.40 in	L 90 cm W 90 cm H 1 cm	L 35.43 in W 35.43 in H 0.40 in
L 120 cm W 80 cm H 1 cm	L 47.24 in W 31.49 in H 0.40 in	L 180 cm W 90 cm H 1 cm	L 70.87 in W 35.43 in H 0.40 in
Ø 80 cm H 1 cm	Ø 34.49 in H 0.40 in		

Cualquier otro color bajo pedido y plazo de entrega. Consultar Departamento Comercial. Any other colour upon request, delivery time varies. Ask the Sales Department. N'importe quelle couleur sur commande et délai de livraison. Consulter le Département Commercial.



# TABLERO WERZALIT®

## WERZALIT® TABLE TOP

### PLATEAU WERZALIT®

Los tableros Werzalit se fabrican según un procedimiento patentado especialmente para su uso en interiores y exteriores. Debido al núcleo del material altamente triturado y prensado y con la superficie prensada homogéneamente con materiales derivados de la madera, los tableros Werzalit logran una larga vida útil, son sumamente sólidos y totalmente resistentes a la intemperie. No se recomienda exponer el werzalit en colores oscuros directamente al sol para evitar que se curve o deforme por efecto de la acumulación de calor.

Werzalit table tops are manufactured specially for use inside and outside using a patented procedure. Due to its high density material core manufactured from naturally grown wood and the surface pressed homogeneously with the wood material, Werzalit table tops are durable, hard-wearing and completely weatherproof. We do not recommend to expose dark werzalit table tops to the sun in order to avoid curving or deforming through the effect of heat accumulation.

Les plateaux de tables Werzalit sont fabriqués selon un procédé breveté en particulier pour un usage intérieur comme extérieur. Grâce à son noyau de haute densité avec particules de bois compressées et homogènes, les plateaux de tables Werzalit sont durables, robustes et absolument résistant aux intempéries. Nous recommandons de ne pas exposer les plateaux Werzalit foncés directement au soleil afin d'éviter qu'ils se courbent et se déforment par l'accumulation de chaleur.



**Cualquier otro color bajo pedido y plazo de entrega. Consultar Departamento Comercial.**

Any other colour upon request, delivery time varies. Ask the Sales Department.

N'importe quelle couleur sur commande et délai de livraison. Consulter le Département Commercial.



**Otros colores o medidas, consultar con el departamento comercial.**

For other colours or sizes please consult commercial department.

Plusieurs couleurs, consulter le département commercial.



Blanco | White | Blanc

Ø 60 cm	Ø 23.62 in	W 60 cm L 60 cm	W 23.62 in L 23.62 in
W 70 cm L 70 cm	W 27.56 in L 27.56 in	W 80 cm L 80 cm	W 31.49 in L 31.49 in
W 90 cm L 90 cm	W 35.43 in L 35.43 in	W 120 cm L 80 cm	W 47.24 in L 31.49 in
W 56,1 cm L 56,4 cm H 77,7 cm	W 22.09 in L 22.20 in H 30.59 in	W 56,1 cm L 56,4 cm H 77,7 cm	W 22.09 in L 22.20 in H 30.59 in



Stratos | Stratos | Stratos

Ø 60 cm	Ø 23.62 in	W 70 cm L 70 cm	W 27.56 in L 27.56 in
W 80 cm L 80 cm	W 31.49 in L 31.49 in	W 120 cm L 80 cm	W 47.24 in L 31.49 in



Wengé | Wenge | Wenge

Ø 60 cm	Ø 23.62 in	W 70 cm L 70 cm	W 27.56 in L 27.56 in
W 80 cm L 80 cm	W 31.49 in L 31.49 in	W 120 cm L 80 cm	W 47.24 in L 31.49 in

# TABLERO DUROLIGHT

## DUROLIGHT TABLE TOP

### PLATEAU DUROLIGHT

Los tableros DUROLight son por su resistencia una opción idónea para el uso interior, y perfectamente combinable con la gama de sillas de Resol Contract. Están realizados de melamina con una imprimación de resina en la superficie que los protege de arañazos y de altas temperaturas (hasta 180°C). Los cantos están sellados con ABS para garantizar un acabado perfecto y resistente (Pruebas realizadas demuestran que son necesarios más de 1.5 Newton para conseguir arañar la superficie y 350 rotaciones para que se experimente desgaste.) Disponibles en color wengé, pino vintage y blanco.

The DUROLight tabletops are an ideal option for indoor use due to their resistance, and perfectly combinable with the range of Resol Contract. They are made of melamine with a resin coating on the surface, which protects them from scratches and high temperatures (up to 180°C). The edges are ABS sealed in order to guarantee a perfect and resistant finish. (Tests carried out showed that more than 1.5 Newton is necessary to achieve scratching the surface and 350 rotations in order to show wear.) Available in the colours wenge, vintage pine and white.

La résistance des planches DUROLight en fait l'option idéale pour un usage intérieur, et pouvant être parfaitement combinées avec la gamme de Resol Contract. Ils sont fabriqués en mélamine avec une couche de résine en surface protégeant des rayures et des hautes températures (jusqu'à 180°C) Les bords sont collés par ABS afin de garantir une finition parfaite et résistante. (Les tests réalisés démontrent qu'il faut plus de 1,5 Newton pour parvenir à rayer la surface et 350 rotations pour que l'usure commence.) Couleurs disponibles: wengé, pin vintage et blanc.



**Standard**  
Wengé | Wenge | Wenge

W 68 cm	W 26.77 in	W 80 cm	W 31.49 in
L 68 cm	L 26.77 in	L 80 cm	L 31.49 in
H 5 cm	H 1.97 in	H 5 cm	H 1.97 in



**Standard**  
Blanco | White | Blanc

W 68 cm	W 26.77 in	W 80 cm	W 31.49 in
L 68 cm	L 26.77 in	L 80 cm	L 31.49 in
H 5 cm	H 1.97 in	H 5 cm	H 1.97 in



**Standard**  
Pino Vintage | Vintage Pine | Pin Vintage

W 68 cm	W 26.77 in	W 80 cm	W 31.49 in
L 68 cm	L 26.77 in	L 80 cm	L 31.49 in
H 5 cm	H 1.97 in	H 5 cm	H 1.97 in



Cualquier otro color bajo pedido y plazo de entrega. Consultar Departamento Comercial.

Any other colour upon request, delivery time varies. Ask the Sales Department.

N'importe quelle couleur sur commande et délai de livraison. Consulter le Département Commercial.



Standard: Acabado de Superficie de Melamina Decorativa + Revestimiento Protector Transparente.

① Standard: Decorative Melamine Surface Finish + Extra Transparent Overlay.

Standard: Finition de surface de mélamine décorative + revêtement protecteur transparent.

Aglomerado de 8 mm.

② 8 mm Chipboard layer.

Agglomérat de 8 mm.

Núcleo Interno Alveolar.

③ Internal Honeycomb core.

Noyau interne alvéolaire.

Canto de Unión de 3 mm de ABS inyectado.

④ 3 mm Support Edge of foamed ABS.

Bord d'union de 3 mm en ABS injecté.

Canto Decorativo de 2 mm de ABS.

⑤ 2 mm ABS Decor Edge.

Bord décoratif de 2 mm en ABS.

COMBINACIONES DE MESAS | TABLE COMBINATIONS | COMBINAISONS DE TABLES

Material Material Matériel	Medidas Measurements Mesures	Neo	Renoir 40x40	Renoir Doble	Renoir Ø40	Renoir 110	Renoir 110 40 x 40	Miró 40x40	Miró Doble	Miró Ø40	Miró 110	Miró 110 40 x 40	Tàpies 40x40	Tàpies doble
----------------------------------	------------------------------------	-----	-----------------	-----------------	---------------	---------------	-----------------------	---------------	---------------	-------------	-------------	---------------------	-----------------	-----------------

HPL



Ø 60	•	•		•	•		•		•	•		•		
Ø 70	•	•		•	•		•		•	•		•	•	
Ø 80	•	•		•			•		•	•			•	
60 x 60	•	•				•	•					•	•	
70 x 70	•	•					•						•	
80 x 80	•	•					•						•	
120 x 80			•					•						•

HPL MADERA

HPL Wood  
HPL bois

Roble natural  
natural oak  
chêne naturel

Roble ceniza  
ashen oak  
chêne cendré

Madera lavada  
Washed wood  
Bois delavé

Ø 60	•	•		•			•		•				•	
70 x 60	•	•					•						•	
70 x 70	•	•					•						•	
80 x 80	•	•					•						•	
120 x 80			•					•						•

WERZALIT



Ø 60	•	•		•	•		•		•	•		•		
60 x 60	•	•				•	•					•	•	
70 x 70	•	•					•						•	
80 x 80	•	•					•						•	
120 x 80			•					•						•

DUROLIGHT



68 x 68	•	•					•						•	
80 x 80	•	•					•						•	

INOX REPULSADO



Ø 60	•													
Ø 70	•													
60 x 60	•													
70 x 70	•													
80 x 80	•													

Las combinaciones disponibles han sido revisadas y aprobadas por el departamento técnico. Para productos destinados a zonas de alta salinidad consultar previamente con departamento comercial / The combinations available have been reviewed and approved by the technical department. Ask previously sales dept. for using our products in high salinity areas / Les combinaisons disponibles ont été examinées et approuvées par le département technique. Produits destinés aux zones de haute salinité consulter à l'avance au dép. commercial.

# COMBINACIONES DE MESAS | TABLE COMBINATIONS | COMBINAISONS DE TABLES

Material Material Matériel	Medidas Measurements Mesures	Tàpies Ø40	Tàpies 110 Ø40	Tàpies 110	Max	Max 120	Max Alto	Raya	Ola	Ibiza S	Ibiza M	Core
----------------------------------	------------------------------------	---------------	-------------------	---------------	-----	------------	----------	------	-----	---------	---------	------

## HPL



Ø 60	●	●		●		●		●				
Ø 70	●			●				●				
Ø 80	●			●				●				
60 x 60			●	●			●	●				
70 x 70				●			●	●		●		●
80 x 80				●			●	●		●		
120 x 80					●						●	

## HPL MADERA

HPL Wood

HPL bois

Roble natural  
natural oak  
chêne naturel

Roble ceniza  
ashen oak  
chêne cendré

Madera lavada  
Washed wood  
Bois delavé



Ø 80	●			●				●				
70 x 60				●								
70 x 70				●			●			●		●
80 x 80				●			●			●		
120 x 80					●						●	

## WERZALIT



Ø 60	●	●		●		●		●				
60 x 60			●	●			●					
70 x 70				●			●		●			
80 x 80				●			●		●			
120 x 80					●						●	

## DUROLIGHT



68 x 68				●								
80 x 80				●								

## INOX REPULSADO



Ø 60				●		●		●				
Ø 70				●				●				
60 x 60				●			●					
70 x 70				●			●					
80 x 80				●			●					

Las combinaciones disponibles han sido revisadas y aprobadas por el departamento técnico. Para productos destinados a zonas de alta salinidad consultar previamente con departamento comercial / The combinations available have been reviewed and approved by the technical department. Ask previously sales dept. for using our products in high salinity areas / Les combinaisons disponibles ont été examinées et approuvées par le département technique. Produits destinés aux zones de haute salinité consulter à l'avance au dép. commercial.



## SKY

Mesa | Table | Table

**CATAS** Siesta

W: ancho / width / largeur. L: largo / length / longueur  
 H: altura / height / hauteur. Hs: altura asiento / seat height /  
 hauteur du siège. Ha: altura brazo / arm height / hauteur du bras  
 Ø: diámetro / diameter / diamètre.

La mesa Sky está fabricada en polipropileno resistente a la intemperie. Con protección UV, lo que asegura que sus colores permanecerán intactos. Se puede desmontar. Para uso interior y exterior.

Sky Table is made of durable weather-resistant polypropylene. It is UV protected which insures the colors will not fade. It can be disassembled. For indoor and outdoor use.

La table SKY est fabriquée en polypropylène résistant aux intempéries. Dotée d'une protection UVA, ce qui permet d'éviter l'usure des couleurs. Pour un usage intérieur et extérieur.

○ Blanco | White | Blanc

● Negro | Black | Noir

● Gris Oscuro | Dark Grey | Gris Foncé

W 80 cm	W 31.50 in
L 80 cm	L 31.50 in
H 74cm	H 29.13 in

STD units	Packaging dim. (cm)	M3/pack	NW units (kg)	Units Container 20'	Units Container 40'	Units Container HC	Units Truck 70m³	Units Truck 100m³
1	82x83x14	0,095	14	336	-	742	-	1.008





# OCTOPUS 60

Mesa | Table | Table



**Siesta**  
FURNITURE

Mesa fabricada en resina muy resistente y duradera. Protección UV. Desmontable. Para uso interior y exterior. Otros colores disponibles, consulte al Departamento Comercial.

Table is made of durable weather-resistant resin. It is UV protected. Can be disassembled. For indoor and outdoor use. Other available colours, contact the Sales Department.

Table fabriquée en résine très résistante et durable. Protection UV. Démontable. Pour usage intérieur et extérieur. Autres couleurs disponibles, consultez le département commercial.

○ Blanco | White | Blanc

● Negro | Black | Noir

● Gris Oscuro | Dark Grey | Gris Foncé

ø 60 cm  
W 60 cm  
H 75 cm

ø 23.62 cm  
W 23.62 in  
H 29.53 in

W: ancho / width / largeur. L: largo / length / longueur  
H: altura / height / hauteur. Hs: altura asiento / seat height /  
hauteur du siège. Ha: altura brazo / arm height / hauteur du bras  
Ø: diámetro / diameter / diamètre.

STD units	Packaging dim. (cm)	M3/pack	NW units (kg)	Units Container 20'	Units Container 40'	Units Container HC	Units Truck 70m³	Units Truck 100m³
2	39,5x62x66	0,15	4,5	350	850	850	-	1.050



# ARES 80

Mesa | Table | Table



Mesa para uso interior y exterior fabricada en resina muy resistente y duradera. Protección UV. Desmontable. Otros colores disponibles, consulte el Departamento Comercial.

Table for indoor and outdoor use, made of very strong and durable resin. UV Protection. It can be dismantled. Other available colours, contact the Sales Department.

Table pour usage intérieur et extérieur, fabriquée en résine très résistante et durable. Protection UV. Démontable. Autres couleurs disponibles, consultez le Département Commercial.

Blanco | White | Blanc

Negro | Black | Noir

W 80 cm | W 31.50 in  
L 80 cm | L 31.50 in  
H 75 cm | H 29.53 in

STD units	Packaging dim. (cm)	M3/ pack	NW units (kg)	Units Container 20'	Units Container 40'	Units Container HC	Units Truck 70m <sup>3</sup>	Units Truck 100m <sup>3</sup>
1	81x81x15	0,09	14	266	660	660	-	800

# ARES 140

Mesa | Table | Table



Mesa para uso interior y exterior fabricada en resina muy resistente y duradera. Protección UV. Desmontable. Otros colores disponibles, consulte el Departamento Comercial.

Table for indoor and outdoor use, made of very strong and durable resin. UV Protection. It can be dismantled. Other available colours, contact the Sales Department.

Table pour usage intérieur et extérieur, fabriquée en résine très résistante et durable. Protection UV. Démontable. Autres couleurs disponibles, consultez le Département Commercial.

Blanco | White | Blanc

Negro | Black | Noir

W 80 cm | W 31.50 in  
L 140 cm | L 55.12 in  
H 75 cm | H 29.53 in

STD units	Packaging dim. (cm)	M3/ pack	NW units (kg)	Units Container 20'	Units Container 40'	Units Container HC	Units Truck 70m <sup>3</sup>	Units Truck 100m <sup>3</sup>
1	141x80x15	0,17	23	165	374	374	-	500





# BALI

Mesa | Table | Table



Bali Test  
Certificates:  
EN 12521



Chocolate | Chocolate | Chocolat

Blanco | White | Blanc



W 94 cm | W 37.01in  
L 94 cm | L 37.01 in  
H 75 cm | H 29.53 in

STD units	Packaging dim. (cm)	M3/ pack	NW units (kg)	Units Container 20'	Units Container 40'	Units Container HC	Units Truck 70m <sup>3</sup>	Units Truck 100m <sup>3</sup>
1	96x96x14	0,12	22	220	460	460	640	640

Mesa cuadrada para uso interior y exterior fabricada en resina muy resistente y duradera reforzada con fibra de vidrio. Protección UV. Sobre de cristal templado oscuro de 5 mm de grosor. De fácil montaje y desmontaje. Otros colores disponibles, consulte el Departamento Comercial.

Square table for indoor and outdoor use made of very strong and durable resin reinforced with fiberglass. UV protection. Table top of tempered dark glass of 5 mm thickness. Easy to assemble and disassemble. Other available colours, contact the Sales Department.

Table carrée pour usage intérieur et extérieur fabriquée en résine très solide et durable renforcée avec fibre de verre. Plateau en verre trempé foncé en 5 mm de grosseur. Montage et démontage faciles. Autres couleurs disponibles, consultez le Département Commercial.

# TAHITI

Mesa | Table | Table



TahitiTest  
Certificates:  
EN 12521



Chocolate | Chocolate | Chocolat



W 94 cm | W 37.01 in  
L 180 cm | L 70.87 in  
H 75 cm | H 29.53 in

Hasta fin de existencias | Until the end of stock | Jusqu'à épuisement du stock

STD units	Packaging dim. (cm)	M3/ pack	NW units (kg)	Units Container 20'	Units Container 40'	Units Container HC	Units Truck 70m <sup>3</sup>	Units Truck 100m <sup>3</sup>
1	184x96x14	0,24	32	112	280	280	320	320

Mesa rectangular para uso interior y exterior fabricada en resina muy resistente y duradera reforzada con fibra de vidrio. Protección UV. Sobre de cristal templado oscuro de 5 mm de grosor. De fácil montaje y desmontaje. Otros colores disponibles, consulte el Departamento Comercial.

Rectangular table for indoor and outdoor use made of very strong and durable resin reinforced with fiberglass. UV protection. Table top of tempered dark glass of 5 mm thickness. Easy to assemble and disassemble. Other available colours, contact the Sales Department.

Table rectangulaire pour usage intérieur et extérieur fabriquée en résine très solide et durable renforcée avec fibre de verre. Plateau en verre trempé foncé en 5 mm de grosseur. Montage et démontage faciles. Autres couleurs disponibles, consultez le Département Commercial.

W: ancho / width / largeur. L: largo / length / longueur  
H: altura / height / hauteur. Hs: altura asiento / seat height /  
hauteur du siège. Ha: altura brazo / arm height / hauteur du bras  
Ø: diámetro / diameter / diamètre.

# ORLANDO 80

Mesa | Table | Table



Mesa para uso interior y exterior fabricada en resina muy resistente y duradera. Protección UV. Desmontable. Otros colores disponibles, consulte el Departamento Comercial.

Table for indoor and outdoor use, made of very strong and durable resin. UV Protection. It can be dismantled. Other available colours, contact the Sales Department.

Table pour usage intérieur et extérieur, fabriquée en résine très résistante et durable. Protection UV. Démontable. Autres couleurs disponibles, consultez le Département Commerciale.

● Chocolate | Chocolate | Chocolat

**Siesta**  
exclusive

W 80 cm | W 31.50 in  
L 80 cm | L 31.50 in  
H 75 cm | H 29.53 in

STD units	Packaging dim. (cm)	M3/ pack	NW units (kg)	Units Container 20'	Units Container 40'	Units Container HC	Units Truck 70m <sup>3</sup>	Units Truck 100m <sup>3</sup>
1	81x81x15	0,09	14	266	660	660	800	800

# ORLANDO 140

Mesa | Table | Table



Mesa para uso interior y exterior fabricada en resina muy resistente y duradera. Protección UV. Desmontable. Otros colores disponibles, consulte el Departamento Comercial.

Table for indoor and outdoor use, made of very strong and durable resin. UV Protection. It can be dismantled. Other available colours, contact the Sales Department.

Table pour usage intérieur et extérieur, fabriquée en résine très résistante et durable. Protection UV. Démontable. Autres couleurs disponibles, consultez le Département Commerciale.

● Chocolate | Chocolate | Chocolat

**Siesta**  
exclusive

W 80 cm | W 31.50 in  
L 140 cm | L 55.12 in  
H 75 cm | H 29.53 in

STD units	Packaging dim. (cm)	M3/ pack	NW units (kg)	Units Container 20'	Units Container 40'	Units Container HC	Units Truck 70m <sup>3</sup>	Units Truck 100m <sup>3</sup>
1	141x81x15	0,17	23	165	374	374	500	500



# MAMBA

Mesa | Table | Table



**Apilable**  
Stackable | Empilable

**W:** ancho / width / largeur. **L:** largo / length / longueur  
**H:** altura / height / hauteur. **Hs:** altura asiento / seat height /  
hauteur du siège. **Ha:** altura brazo / arm height / hauteur du bras  
**Ø:** diámetro / diameter / diamètre.

Mesa para uso interior y exterior de aluminio pintado por pulverización en color negro. Sobre de cristal de 8 mm de grosor pintado en color negro.

Black Spray painted aluminium table for indoor and outdoor use. Table top of painted glass in black with 8 mm thickness.

Table pour usage intérieur et extérieur en aluminium peint par pulvérisation de couleur noir, Plateau en verre de 8 mm de grousseur, peint en noir.

● Negro | Black | Noir

W 80 cm	W 31.50 in
L 80 cm	L 31.50 in
H 74 cm	H 29.13 in

STD units	Packaging dim. (cm)	M3/ pack	NW units (kg)	Units Container 20'	Units Container 40'	Units Container HC	Units Truck 70m <sup>3</sup>	Units Truck 100m <sup>3</sup>
1	83x83x10	0,07	13	312	780	780	941	941

# SHIO

Mesa | Table | Table



Mesa para uso interior y exterior de aluminio pintado por pulverización en color blanco. Sobre de cristal templado de 8 mm de grosor pintado en color blanco.

White powder-coated aluminium table for indoor and outdoor use. Table top of painted tempered glass in white with an 8 mm thickness.

Table pour usage intérieur ou extérieur en aluminium peint par pulvérisation de couleur blanc, avec plateau en verre trempé de 8 mm. de grousseur, peint en blanc.

○ Blanco | White | Blanc

W 80 cm	W 31.50 in
L 80 cm	L 31.50 in
H 74 cm	H 29.13 in

STD units	Packaging dim. (cm)	M3/ pack	NW units (kg)	Units Container 20'	Units Container 40'	Units Container HC	Units Traylor 70m <sup>3</sup>	Units Truck 100m <sup>3</sup>
1	84x84x10	0,06	20	320	800	800	965	965

# CUBIC

Mesa | Table | Table



Mesa para uso interior y exterior de aluminio pintado por pulverización en gris claro. Sobre de cristal templado de 8 mm de grosor.

Light grey powder-coated aluminium table for indoor and outdoor use. 8 mm thickness tempered glass table top.

Table pour usage intérieur ou extérieur en aluminium peint par pulvérisation de couleur gris clair avec plateau en verre trempé de 8 mm.

● Gris | Grey | Gris

L 80 cm	L 31.50 in
W 80 cm	W 31.50 in
H 74 cm	H 29.13 in

STD units	Packaging dim. (cm)	M3/ pack	NW units (kg)	Units Container 20'	Units Container 40'	Units Container HC	Units Truck 70m <sup>3</sup>	Units Truck 100m <sup>3</sup>
1	84x84x10	0,06	17,5	320	800	800	965	965

# WOOD NEW FLASH

Mesa | Table | Table



**W:** ancho / width / largeur. **L:** largo / length / longueur  
**H:** altura / height / hauteur. **Hs:** altura asiento / seat height /  
 hauteur du siège. **Ha:** altura brazo / arm height / hauteur du bras  
**Ø:** diámetro / diameter / diamètre.

Mesa para uso interior y exterior. Sobre inyectado en polipropileno. Patas de madera. Protección UV. Disponible en 2 medidas: 90x90 y 160x90.

Table for indoor and outdoor use. Table top injected with polypropylene. Wood legs. UV Protection. Available in two sizes: 90x90 and 160x90.

Table d'intérieur et extérieur. Plateau injecté en polypropylène. Pieds de bois. Protection UV. Disponible dans 2 mesures: 90x90 et 160x90.

○ Blanco   White   Blanc	W 90 cm	W 35.43 in	W 90 cm	W 35.43 in
● Chocolate   Chocolate   Chocolat	L 90 cm	L 35.56 in	L 160 cm	L 62.99 in
● Gris Oscuro   Dark Grey   Gris Foncé	H 74 cm	H 29.13 in	H 74 cm	H 29.13 in

STD units	Packaging dim. (cm)	M3/ pack	NW units (kg)	Units Container 20'	Units Container 40'	Units Container HC	Units Truck 70m <sup>3</sup>	Units Truck 100m <sup>3</sup>
1	94x92x15	0,13	11,85	180	390	442	448	578
1	161x92x15	0,22	16,59	90	210	238	256	323

Silla Oslo (p. 230) con mesa Wood New Flash (p.273)  
 Oslo chair (p. 230) with Wood New Flash table (p.273)  
 Chaise Oslo (p. 230) avec table Wood New Flash (p.273)



# ALEGRIA

Mesa | Table | table



Mesa para uso interior y exterior de aluminio pintado por pulverización en color blanco. Disponible en formato 70x70 y 140x80 cm. Peso neto 70x70, 8,8 kg 140x80, 13,17 kg.

Table for indoor and outdoor use in white powder coated aluminium. Available in 70x70 and 140x80 cm. Net weight 70x70, 8,8 kg (19.40 lb) 140x80, 13,17 kg (29.03 lb).

Table Alegria pour usage intérieure et extérieure peint par pulvérisation en couleur blanche. Disponible en 70x70 cm et 140x80 cm. Poids net 70x70, 8,8 kg 140x80, 13,17 kg.

- Blanco | White | Blanc
 

W 70 cm	W 27.56 in	W 140 cm	W 55.12 in
L 70 cm	L 27.56 in	L 80 cm	L 31.50 in
H 75 cm	H 29.52 in	H 75 cm	H 29.52 in

W: ancho / width / largeur. L: largo / length / longueur  
 H: altura / height / hauteur. Hs: altura asiento / seat height / hauteur du siège. Ha: altura brazo / arm height / hauteur du bras  
 Ø: diámetro / diameter / diamètre.

STD units	Packaging dim. (cm)	M3/ pack	NW units (kg)	Units Container 20'	Units Container 40'	Units Container HC	Units Truck 70m <sup>3</sup>	Units Truck 100m <sup>3</sup>
14	100x100x235	2,35	8,8	495	990	-	-	-
14	162x162x235	6,17	13,17	264	572	-	-	-

# MONTBLANC

Mesa | Table | Table



Mesa de 80 x 80 cm con sobre Werzalit. Pies atornillados de aluminio anodizado mate.

Table 80 x 80 cm with Werzalit table top. Screwed anodized aluminium legs. Matt finish.

Table 80 x 80 cm avec plateau Werzalit. Pieds vissés en aluminium anodisé mat.

- Stratos | Stratos | Stratos
- Blanco | White | Blanc
 

W 80 cm	W 31.50 in
L 80 cm	L 31.50 in
H 73 cm	H 28.74 in
- Wengé | Wenge | Wenge

W: ancho / width / largeur. L: largo / length / longueur  
 H: altura / height / hauteur. Hs: altura asiento / seat height / hauteur du siège. Ha: altura brazo / arm height / hauteur du bras  
 Ø: diámetro / diameter / diamètre.

STD units	Packaging dim. (cm)	M3/ pack	NW units (kg)	Units Container 20'	Units Container 40'	Units Container HC	Units Truck 70m <sup>3</sup>	Units Truck 100m <sup>3</sup>
1	81x81x17	0,11	10,7	245	518	609	636	909

# RIPOLL

Mesa | Table | Table



Mesa de 120 x 80 cm con sobre Werzalit. Pies de aluminio anodizado mate.

Table 120 x 80 cm with Werzalit table top. Anodized aluminium legs. Matt finish.

Table 120 x 80 cm avec plateau Werzalit. Pieds en aluminium anodisé mat.

- Blanco | White | Blanc
 

W 80 cm	W 31.50 in
L 120 cm	L 47.24 in
H 73 cm	H 28.74 in
- Wengé | Wenge | Wenge
- Stratos | Stratos | Stratos

STD units	Packaging dim. (cm)	M3/ pack	NW units (kg)	Units Container 20'	Units Container 40'	Units Container HC	Units Truck 70m <sup>3</sup>	Units Truck 100m <sup>3</sup>
1	121x82x17	0,17	16,1	124	254	302	312	422

## KIBO

Mesa | Table | Table



Mesa de metal pintado con acabado antiguo. Apilable. Para uso interior y exterior. Mesa combinable con silla Kibo (ver pag. 254).

Metal table with antique cream finished. Stackable. For indoor and outdoor use. Table combinable with Kibo chair (See at pag. 254).

Table en métal peinte avec finition ancienne. Empilable. Pour usage intérieur et extérieur. Table combinable avec chaise Kibo (Voir pag. 254).

● Crema | Cream | Crème

W 80 cm | W 31.50 in  
L 80 cm | L 31.50 in  
H 75 cm | H 29.53 in

STD units	Packaging dim. (cm)	M3/ pack	NW units (kg)	Units Container 20'	Units Container 40'	Units Container HC	Units Truck 70m³	Units Truck 100m³
1	82x82x12	-	-	330	680	680	-	-

## NAXOS

Mesa | Table | Table



Mesa redonda para uso interior y exterior de aluminio. Sobre en mosaico.

Circular aluminium table for indoor and outdoor use. Mosaic table top.

Table ronde pour un usage intérieur et extérieur en aluminium. Plateau en mosaïque.

Ø 59 cm | Ø 23.23 in  
H 71 cm | H 27.95 in

STD units	Packaging dim. (cm)	M3/ pack	NW units (kg)	Units Container 20'	Units Container 40'	Units Container HC	Units Truck 70m³	Units Truck 100m³
1	63x10x75	0,07	24	571	1.206	1.418	-	-

## PAROS

Mesa | Table | table



Mesa para uso interior y exterior de aluminio. Sobre en mosaico.

Aluminium table for indoor and outdoor use. Mosaic table top.

Table pour un usage intérieur et extérieur en aluminium. Plateau en mosaïque.

W 70 cm | W 27.56 in  
L 70 cm | L 27.56 in  
H 75 cm | H 29.53 in

STD units	Packaging dim. (cm)	M3/ pack	NW units (kg)	Units Container 20'	Units Container 40'	Units Container HC	Units Truck 70m³	Units Truck 100m³
1	75x10x75	0,056		780	1.013	1.191	-	-

W: ancho / width / largeur. L: largo / length / longueur  
H: altura / height / hauteur. Hs: altura asiento / seat height / hauteur du siège. Ha: altura brazo / arm height / hauteur du bras  
Ø: diámetro / diameter / diamètre.

## BERLIN

Mesa | Table | Table



Mesa apilable para uso interior y exterior con patas de acero enroscables. Sobre fabricado a partir de dos piezas inyectadas en polipropileno aditivado con protector de rayos UV, y soldadas por vibración. Patas de acero de Ø30x1,5 mm de grosor, pintadas por pulverización al horno con pintura poliéster. Agujero parasol de 38mm con tapa. Combinable con parasoles UD2 y MD1 (catálogo Garden).

Stackable table for indoor and outdoor use with threaded steel legs. Tabletop manufactured from two pieces injected in polypropylene additive with UV protection, and welded by vibration. Steel legs Ø30x1.5 mm thick, spray-painted in the oven with polyester paint. Hole of 38mm with lid. Combinable with parasols UD2 and MD1 (Garden catalogue).

Table empilable pour usage intérieur et extérieur avec pieds en acier filetés. Dessus de table fabriqué à partir de deux pièces injectées en polypropylène avec protection UV, et soudé par vibration. Pieds en acier Ø30x1,5 mm d'épaisseur, peints au pistolet à four avec peinture polyester. Parasol 38 mm avec couvercle. Combinable avec parasols UD2 et MD1 (catalogue Garden).

W 70 cm | W 27.56 in  
L 70 cm | L 27.56 in  
H 74 cm | H 29.13 in

Sobre + patas | table + legs | plateau + pieds

Blanco/blanco | White/White | Blanc/Blanc

Rojo/Rojo | Red/Red | Rouge/Rouge

STD units	Packaging dim. (cm)	M3/ pack	NW units (kg)	Units Container 20'	Units Container 40'	Units Container HC	Units Truck 70m³	Units Truck 100m³
1	79x79x7,5	0,05	5,7	297	675	675	891	972
27	80x120x220	2,11	5,7	297	675	675	891	972

## ZURICH

Mesa | Table | Table



Mesa apilable para uso interior y exterior con patas de acero enroscables. Sobre fabricado a partir de dos piezas inyectadas en polipropileno aditivado con protector de rayos UV y soldadas por vibración. Patas de acero de Ø30x1,5 mm de grosor, pintadas por pulverización al horno con pintura poliéster.

Stackable table for indoor and outdoor use with threaded steel legs. Tabletop manufactured from two pieces injected in polypropylene additive with UV protection and welded by vibration. Steel legs Ø30x1.5 mm thick, spray-painted in the oven with polyester paint.

Table empilable pour usage intérieur et extérieur avec pieds en acier filetés. Dessus de table fabriqué à partir de deux pièces injectées en additif polypropylène avec protection UV et soudées par vibration. Pieds en acier Ø30x1,5 mm d'épaisseur, peints au pistolet au four avec peinture polyester.

Blanco/blanco | White/White | Blanc/Blanc

Arena/Arena | Sand/Sand | Sable/Sable

Rojo/Rojo | Red/Red | Rouge/Rouge

Sobre + patas | table + legs | plateau + pieds

W 70 cm | W 27.56 in  
L 70 cm | L 27.56 in  
H 74 cm | H 29.13 in

Apilable  
Stackable | Empilable

W: ancho / width / largeur. L: largo / length / longueur  
H: altura / height / hauteur. Hs: altura asiento / seat height / hauteur du siège. Ha: altura brazo / arm height / hauteur du bras  
Ø: diámetro / diameter / diamètre.

STD units	Packaging dim. (cm)	M3/ pack	NW units (kg)	Units Container 20'	Units Container 40'	Units Container HC	Units Truck 70m³	Units Truck 100m³
1	79x79x7,5	0,05	5,7	297	675	675	891	972
27	80x120x220	2,11	5,7	297	675	675	891	972



# MARSELLA

Mesa | Table | Table



Mesa apilable para uso interior y exterior con patas polipropileno y fibra de vidrio enroscables. Sobre fabricado a partir de dos piezas inyectadas en polipropileno aditivado con protector de rayos UV y soldadas por vibración.

Stackable table for indoor and outdoor use with screwed polypropylene and fiberglass legs. Tabletop manufactured from two pieces injected in polypropylene additive with UV protection and welded by vibration.

Table empilable pour usage intérieur et extérieur avec pieds vissés en polypropylène et fibre de verre. Dessus de table fabriqué à partir de deux pièces injectées en polypropylène avec protection UV et soudées par vibration.

Sobre + patas | table + legs | plateau + pieds

W 70 cm | W 27.56 in  
L 70 cm | L 27.56 in  
H 74 cm | H 29.13 in

- Arena/Arena | Sand/Sand | Sable/Sable
- Blanco/blanco | White/White | Blanc/Blanc
- Arena/Blanco | Sand/White | Sable /Blanc

STD units	Packaging dim. (cm)	M3/ pack	NW units (kg)	Units Container 20'	Units Container 40'	Units Container HC	Units Truck 70m <sup>3</sup>	Units Truck 100m <sup>3</sup>
1	79x79x7,5	0,05	5,7	297	675	675	891	972
27	80x120x220	2,11	5,7	297	675	675	891	972

# LONDON

Mesa | Table | Table



Mesa apilable para uso interior y exterior con patas polipropileno y fibra de vidrio enroscables. Sobre fabricado a partir de dos piezas inyectadas en polipropileno aditivado con protector de rayos UV y soldadas por vibración. Agujero parasol de 38mm con tapa. Combinable con parasoles UD2 y MD1 (catálogo Garden).

Stackable table for indoor and outdoor use with screwed polypropylene and fiberglass legs. Tabletop manufactured from two pieces injected in polypropylene additive with UV protection and welded by vibration. Hole of 38mm with lid. Combinable with parasols UD2 and MD1 (Garden catalogue).

Table empilable pour usage intérieur et extérieur avec pieds vissés en polypropylène et fibre de verre. Dessus de table fabriqué à partir de deux pièces injectées en additif de polypropylène avec protection UV et soudées par vibration. Parasol 38mm avec couvercle. Combinable avec parasols UD2 et MD1 (catalogue Garden).

Sobre + patas | table + legs | plateau + pieds

W 70 cm | W 27.56 in  
L 70 cm | L 27.56 in  
H 74 cm | H 29.13 in

- Blanco/blanco | White/White | Blanc/Blanc
- Arena/Arena | Sand/Sand | Sable/Sable

STD units	Packaging dim. (cm)	M3/ pack	NW units (kg)	Units Container 20'	Units Container 40'	Units Container HC	Units Truck 70m <sup>3</sup>	Units Truck 100m <sup>3</sup>
1	79x79x7,5	0,05	5,7	297	675	675	891	972
27	80x120x220	2,11	5,7	297	675	675	891	972





Silla Malta con respaldo bajo (pág. 235) con mesas Zurich y Berlin (pág. 276)  
Low backrest armchair (pag. 235) with Zurich table and Berlin table (pag. 276)  
Fauteuil Malta dossier bas (pag. 235) avec table Zurich et table Berlin (pag. 276)



# MALTA

## DAVID CARRASCO BARCELÓ

Mesa | Table | Table



○ Blanco | White | Blanc

● Rojo | Red | Rouge

W 70 cm | W 27.56 in  
L 70 cm | L 27.56 in  
H 75 cm | H 29.53 in

STD units	Packaging dim. (cm)	M3/ pack	NW units (kg)	Units Container 20'	Units Container 40'	Units Container HC	Units Truck 70m <sup>3</sup>	Units Truck 100m <sup>3</sup>
30	100x120x240	2,9	9,7	300	702	792	-	858

Mesa apilable para uso interior y exterior. Sobre fabricado a partir de dos piezas inyectadas en polipropileno aditivado con protector de rayos UV, y soldadas por vibración. Patas de acero de Ø30x1,5 mm de grosor, pintadas por pulverización al horno con pintura poliéster. Dispone de 4 colgadores en la parte inferior del tablero para mayor comodidad y seguridad. Agujero parasol de 38mm con tapa. Peso neto 9,70 kg. Combinables con parasoles UD2 y MD1 (catálogo Garden).

Stackable table for indoor and outdoor use. Steel legs Ø30x1,5 mm thick, polyester powder-coating painted. Table top made in two pieces injected in polypropylene with UV protection joined by ultrasonic welding. It has 4 hangers in the table top bottom to offer more comfortability and security. 38mm umbrella hole with cap. Net weight 9,70 kg (21.38 lb). Combinable with parasols UD2 and MD1 (Garden catalogue).

Table empilable pour une utilisation intérieure et extérieure. Pieds fabriqués en acier mm Ø30x1,5 mm épaisseur, peintes avec de la peinture polyester. Plateau réalisé en deux pièces injectées en polypropylène avec protection UV avec soudage par ultrasons. Elle dispose de 4 crochets en dessous du plateau pour offrir plus de confort et de sécurité. Trou de parasol du 38mm avec cache-trou. Poids net 9,70 kg. Combinable avec parasols UD2 et MD1 ( catalogue Garden).

# CORE

Mesa | Table | table



Mesa apilable cuadrada para uso interior y exterior. Patas de acero Ø28 pintadas por pulverización al horno con pintura poliéster. Tablero disponible en compacto fenólico de 70x70 (Ver colores en pág. 296)

Stackable squared table for indoor and outdoor use. Steel legs Ø28 mm, polyester powder-coating painted. Table top available in HPL of 70x70. (See colours on p. 296)

Table empilable carée pour usage intérieur et extérieur. Pieds fabriqués en acier Ø28mm peintes avec de la peinture polyester. Tableau disponible en résine phénolique de 70x70. (Voir couleurs pag. 296)

W 70 cm | W 27.56 in  
L 70 cm | L 27.56 in  
H 74 cm | H 29.13 in

Apilable  
Stackable | Empilable

W: ancho / width / largeur. L: largo / length / longueur  
H: altura / height / hauteur. Hs: altura asiento / seat height / hauteur du siège. Ha: altura brazo / arm height / hauteur du bras  
Ø: diámetro / diameter / diamètre.

STD units	Packaging dim. (cm)	M3/ pack	NW units (kg)	Units Container 20'	Units Container 40'	Units Container HC	Units Truck 70m <sup>3</sup>	Units Truck 100m <sup>3</sup>
1	82x82x12	0,04	11	550	1.250	1.250	1.650	1.800
50	80x120x220	2,11	11	550	1.250	1.250	1.650	1.800
1	80x120x90	0,86	11	220	500	500	660	720
50	80x120x220	2,11	11	220	500	500	660	720







# RAYA

Mesa | Table | Table



Raya Test Certificates:  
EN 581-1  
EN 581-2  
General Public Use

Mesa apilable cuadrada (60 x 60 / 70 x 70 / 80 x 80 cm) para exterior. Estructura tubular, ø 28 x 2 mm de grosor, de aluminio anodizado brillante. Tablero de 20 mm con sobre de Inox 304 repulsado con grosor de 2mm, con interior aglomerado de alta densidad con tratamiento ignífugo e hidrófugo. Tornillos de acero inoxidable.

Stackable square table (60 x 60 / 70 x 70 / 80 x 80 cm) for outdoor use. Tubular shaped frame, ø 28 x 2 mm thick, anodized aluminium, shiny finish. Table top 20 mm thick with 304 stainless Steel bevelled top 2 mm thick. High density conglomerate core with fire retardant and water repellent treatment. Stainless steel screws.

Table empilable carrée (60 x 60 / 70 x 70 / 80 x 80 cm) pour extérieur. Structure tubulaire, ø 28 x 2 mm de grosueur, en aluminium anodisé brillant. Plateau de 20 mm de grosueur, avec surface en Inox 304 repoussé de 2 mm de grosueur, avec intérieur aggloméré de haute desité avec traitment L 60 x W 60 x H 70 cm hydrofuge et antifeu. Vis en acier inoxydable.

L 60 cm	L 23.62 in	L 70 cm	L 27.56 in	L 80 cm	L 31.50 in
W 60 cm	W 23.62 in	W 70 cm	W 27.56 in	W 80 cm	W 31.50 in
H 70 cm	H 27.56 in	H 70 cm	H 27.56 in	H 70 cm	H 27.56 in

STD units	Packaging dim. (cm)	M3/ pack	NW units (kg)	Units Container 20'	Units Container 40'	Units Container HC	Units Truck 70m³	Units Truck 100m³
18	75x75x235	1,32	11,5	432	864	864	918	1.026

# RAYA 2

Mesa | Table | Table



Mesa apilable cuadrada (60 x 60 / 70 x 70 / 80 x 80 cm) para exterior. Estructura tubular, ø 28x 2 mm de grosor, de aluminio anodizado brillante. Tablero Werzalit.

Stackable square table (60 x 60 / 70 x 70 / 80 x 80 cm) for outdoor use. Tubular shaped frame, ø 28 x 2 mm thick, anodized aluminium, shiny finish. Werzalit table top.

Table empilable carrée (60 x 60 / 70 x 70 / 80 x 80 cm) pour extérieur. Structure tubulaire, ø 28x 2 mm de grosueur, en aluminium anodisé brillant. Plateau en Werzalit.

L 60 cm	L 23.62 in	L 70 cm	L 27.56 in	L 80 cm	L 31.50 in
W 60 cm	W 23.62 in	W 70 cm	W 27.56 in	W 80 cm	W 31.50 in
H 72 cm	H 28.35 in	H 72 cm	H 28.35 in	H 72 cm	H 28.35 in

# RAYA 3

Mesa | Table | Table



Mesa apilable cuadrada (60 x 60 / 70 x 70 / 80 x 80 cm) para exterior. Estructura tubular, ø 28 x 2 mm de grosor, de aluminio anodizado brillante. Tablero en compacto fenólico. (Ver colores en pág. 296).

Stackable square table (60 x 60 / 70 x 70 / 80 x 80 cm) for outdoor use. Tubular shaped frame, ø 28 x 2 mm thick, anodized aluminium, shiny finish. HPL table top. (See colors on p. 296).

Table empilable carrée (60 x 60 / 70 x 70 / 80 x 80 cm) pour extérieur. Structure tubulaire, ø 28 x 2 mm de grosueur, en aluminium anodisé brillant. Plateau en résine phénolique. (Voir couleurs pag. 296).

Apilable  
Stackable | Empilable



W 80 cm	W 31.50 in
L 80 cm	L 31.50 in
H 72 cm	H 28.34 in

W: ancho / width / largeur. L: largo / length / longueur  
H: altura / height / hauteur. Hs: altura asiento / seat height / hauteur du siège. Ha: altura brazo / arm height / hauteur du bras  
Ø: diámetro / diameter / diamètre.

## OLA

Mesa | Table | Table



ø 60 cm | ø 23.62 in  
 ø 70 cm | ø 27.56 in  
 H 70 cm | H 27.56 in

Mesa apilable redonda (ø 60 / ø 70 cm) para exterior. Estructura tubular, ø 28 x 2 mm de grosor, de aluminio anodizado brillante. Tablero de 20 mm con sobre de Inox 304 repulsado con grosor de 2mm, con interior aglomerado de alta densidad con tratamiento ignífugo e hidrófugo. Tornillos de acero inoxidable.

Stackable round table (ø 60 / ø 70 cm) for outdoor use. Tubular shaped frame, ø 28 x 2 mm thick, anodized aluminium, shiny finish. Table top 20 mm thick with 304 stainless Steel bevelled top 2 mm thick. High density conglomerate core with fire retardant and water repellent treatment. Stainless steel screws.

Table empilable ronde (ø 60 / ø 70 cm) pour extérieur. Structure tubulaire, ø 28 x 2 mm de grosueur, en aluminium anodisé brillant. Plateau de 20 mm de grosueur, avec surface en Inox 304 repoussé de 2 mm de grosueur. Avec intérieur aggloméré de haute densité avec traitement hydrofuge et antifeu. Vis en acier inoxydable.

STD units	Packaging dim. (cm)	M3/ pack	NW units (kg)	Units Container 20'	Units Container 40'	Units Container HC	Units Truck 70m³	Units Truck 100m³
20	63x63x23	0,91	7,7	540	1.140	1.140	1.260	1.440
20	73x73x230	1,22	10,2	480	960	960	1.080	1.200

## OLA 2

Mesa | Table | Table



Mesa apilable redonda para exterior. Estructura tubular, ø 28 x 2mm de grosor, de aluminio anodizado brillante. Tablero Werzalit. (Ver colores en pág. 294).

Stackable round table for outdoor use. Tubular shaped frame, ø 28 x 2 mm thick, anodized aluminium, shiny finish. Werzalit table top. (See colors on p. 294).

Table empilable ronde pour extérieur. Structure tubulaire, ø 28 x 2 mm de grosueur, en aluminium anodisé brillant. Plateau Werzalit. (Voir couleurs pag. 294).



ø 60 cm | ø 23.62 in  
 H 72 cm | H 28.34 in

## OLA 3

Mesa | Table | Table



Mesa apilable redonda (ø 60 / ø 70 / ø 80 cm) para exterior. Estructura tubular, ø 28 x 2 mm de grosor, de aluminio anodizado brillante. Tablero Compacto Fenólico. (Ver colores en pág. 296).

Stackable round table (ø 60 / ø 70 / ø 80 cm) for outdoor use. Tubular shaped frame, ø 28 x 2 mm thick, anodized aluminium, shiny finish. HPL table top. (See colors on p. 296).

Table empilable ronde (ø 60 / ø 70 / ø 80 cm) pour extérieur. Structure tubulaire, ø 28 x 2 mm de grosueur, en aluminium anodisé brillant. Plateau Résine Phénolique. (Voir couleurs pag. 296).

 Apilable  
 Stackable | Empilable



ø 60 cm | ø 23.62 in  
 ø 70 cm | ø 27.56 in  
 ø 80 cm | ø 31.49 in  
 H 72 cm | H 28.34 in

**W:** ancho / width / largeur. **L:** largo / length / longueur  
**H:** altura / height / hauteur. **Hs:** altura asiento / seat height / hauteur du siège. **Ha:** altura brazo / arm height / hauteur du bras  
**Ø:** diámetro / diameter / diamètre.

# BEACH BAR

Mesa | Table | Table



Mesa monobloc para uso exterior. Inyectada en polipropileno. Apilable. Protección UV. Con agujero para sombrilla. Peso neto 4,75 kg.

Monoblock table for outdoor use. Injected in polypropylene. Stackable. UV Protection. It has a hole for umbrella. Net weight 4,7 kg (10.36 lb).

Table monobloc pour extérieur. Injectée en polypropylène. Empilable. Protection UV. Avec trou de parasol. Poids net 4,75 kg.

Apilable  
Stackable | Empilable

Blanco | White | Blanc

Verde Oscuro | Dark Green | Vert Foncé

W 70 cm

L 70 cm

H 72 cm

W 27.56 in

L 27.56 in

H 28.35 in

W: ancho / width / largeur. L: largo / length / longueur

H: altura / height / hauteur. Hs: altura asiento / seat height / hauteur du siège. Ha: altura brazo / arm height / hauteur du bras

Ø: diámetro / diameter / diamètre.

STD units	Packaging dim. (cm)	M3/ pack	NW units (kg)	Units Container 20'	Units Container 40'	Units Container HC	Units Trayler 70m <sup>3</sup>	Units Truck 100m <sup>3</sup>
27	82x75x225	1,38	4,75	486	1.107	1.107	1.323	1.323

# SKY LOUNGE

Mesa auxiliar | Side table | Table auxiliaire

NEW



La mesa Sky lounge está fabricada en polipropileno resistente a la intemperie. Con protección UV, lo que asegura que sus colores permanecieran intactos. Se puede desmontar. Para uso interior y exterior.

Sky lounge table is made of durable weather-resistant polypropylene. It is UV protected which insures the colors will not fade. Can be disassembled. For indoor and outdoor use.

La table SKY lounge est fabriquée en polypropylène résistant aux intempéries. Dotée d'une protection UVA, ce qui permet d'éviter l'usure des couleurs. Pour un usage intérieur et extérieur.

Blanco | White | Blanc

Negro | Black | Noir

Gris Oscuro | Dark Grey | Gris Foncé

W 100 cm

L 60 cm

H 40 cm

W 39.37 in

L 23.62 in

H 15.75 in

W: ancho / width / largeur. L: largo / length / longueur

H: altura / height / hauteur. Hs: altura asiento / seat height / hauteur du siège. Ha: altura brazo / arm height / hauteur du bras

Ø: diámetro / diameter / diamètre.

STD units	Packaging dim. (cm)	M3/ pack	NW units (kg)	Units Container 20'	Units Container 40'	Units Container HC	Units Truck 70m <sup>3</sup>	Units Truck 100m <sup>3</sup>
1	101x61x9	0,055	7,3	500	-	1.200	-	1.400



Mesa Sky Lounge (p. 284) Silla Sky Lounge (p. 211)  
Sky Lounge table (p. 284) Sky Lounge chair (p. 211)  
Table Sky Lounge (p. 284) Chaise Sky Lounge (p. 211)

Los precios pueden estar desactualizados. Llámanos al 91 161 03 04 para consultar los precios en vigor.



## MIAMI

Mesa | Table | Table



Mesa de centro para uso interior y exterior fabricada en resina muy resistente y duradera reforzada con fibra de vidrio. Protección UV. Otros colores disponibles, consulte el Departamento Comercial.

Coffee table for indoor and outdoor use made of very strong and durable resin reinforced with fiberglass. UV protection. Other available colours, contact the Sales Department.

Table basse pour usage intérieur et extérieur fabriquée en résine très solide et durable renforcée avec fibre de verre. Protection UV. Autres couleurs disponibles, consultez le Département Commerciale.

● Chocolate | Chocolate | Chocolat

W 92 cm | W 36.22 in

○ Blanco | White | Blanc

L 53 cm | L 20.87 in  
H 45 cm | H 17.72 in

**Siesta**  
exclusive

STD units	Packaging dim. (cm)	M3/ pack	NW units (kg)	Units Container 20'	Units Container 40'	Units Container HC	Units Truck 70m³	Units Truck 100m³
1	93x54x15	0,07	4,6	400	800	800	1.000	1.000

## MIAMI

Mesa auxiliar |

Side table |

Table auxiliaire



Mesa auxiliar para uso interior y exterior fabricada en resina muy resistente y duradera reforzada con fibra de vidrio. Protección UV. Otros colores disponibles, consulte el Departamento Comercial.

Side table for indoor and outdoor use made of very strong and durable resin reinforced with fiberglass. UV protection. Other available colours, contact the Sales Department.

Table auxiliaire pour usage intérieur et extérieur fabriquée en résine très solide et durable renforcée avec fibre de verre. Protection UV. Autres couleurs disponibles, consultez le Département Commerciale.

● Chocolate | Chocolate | Chocolat

W 45 cm | W 17.72 in

○ Blanco | White | Blanc

L 45 cm | L 17.72 in  
H 45 cm | H 17.72 in

**Siesta**  
exclusive

STD units	Packaging dim. (cm)	M3/ pack	NW units (kg)	Units Container 20'	Units Container 40'	Units Container HC	Units Truck 70m³	Units Truck 100m³
1	47x47x15	0,03	2,5	900	1.800	1.800	2.400	2.400

W: ancho / width / largeur. L: largo / length / longueur

H: altura / height / hauteur. Hs: altura asiento / seat height / hauteur du siège. Ha: altura brazo / arm height / hauteur du bras

Ø: diámetro / diameter / diamètre.

## MONACO MESA RATTAN

Mesa | Table | Table



Mesa para uso interior y exterior fabricada en resina muy resistente y duradera reforzada con fibra de vidrio. Protección UV. Se puede desmontar. Otros colores disponibles, consulte el Departamento Comercial.

Table for indoor and outdoor made of very strong and durable resin reinforced with fiberglass. UV protection. Can be disassembled. Other available colours, contact the Sales Department.

Table pour une utilisation intérieure et extérieure fabriqué en résine très solide et durable renforcé avec fibre de verre. Protection UV. Peut être démonté. Autres couleurs disponibles, consultez le Département Commerciale.

● Chocolate | Chocolate | Chocolat

W 92 cm | W 36.22 in

**Siesta**  
exclusive

L 57 cm | L 22.44 in  
H 45 cm | H 17.71 in

STD units	Packaging dim. (cm)	M3/ pack	NW units (kg)	Units Container 20'	Units Container 40'	Units Container HC	Units Truck 70m³	Units Truck 100m³
1x	94x58x18	0,098	10	330	800	800	950	-

W: ancho / width / largeur. L: largo / length / longueur

H: altura / height / hauteur. Hs: altura asiento / seat height / hauteur du siège. Ha: altura brazo / arm height / hauteur du bras

Ø: diámetro / diameter / diamètre.



# OCTOPUS BAR

Mesa | Table | Table



Mesa fabricada en resina muy resistente y duradera. Protección UV. Estructura metálica. Desmontable. Para uso interior y exterior. Otros colores disponibles, consulte al Departamento Comercial.

Table is made of durable weather-resistant resin. It is UV protected. Metallic frame. Can be disassembled. For indoor and outdoor use. Other available colours, contact the Sales Department.

Table fabriquée en résine très résistante et durable. Protection UV. Structure métallique. Démontable. Pour usage intérieur et extérieur. Autres couleurs disponibles, consultez le département commercial.

Blanco | White | Blanc

Gris Oscuro | Dark Grey | Gris Foncé

Ø 60 cm | Ø 23.62 in  
W 60 cm | W 23.62 in  
H 108 cm | H 42.52 in

W: ancho / width / largeur. L: largo / length / longueur  
H: altura / height / hauteur. Hs: altura asiento / seat height / hauteur du siège. Ha: altura brazo / arm height / hauteur du bras  
Ø: diámetro / diameter / diamètre.

STD units	Packaging dim. (cm)	M3/ pack	NW units (kg)	Units Container 20'	Units Container 40'	Units Container HC	Units Truck 70m³	Units Truck 100m³
2	39x76x64	0,19	5	280	700	700	-	850

# ESCULAPI

Mesa | Table | Table



Mesa para uso exterior inyectada en polipropileno con pie central embutido con gran estabilidad. Disponible en redonda de Ø70 cm y cuadrada de 70x70 cm. Peso neto Ø70, 7,25 kg, 70x70, 9,4 kg.

Table for outdoor use injected in polypropylene with pressure-fitted pedestal base with great stability. Available in round Ø70 cm and squared 70x70 cm. Net weight Ø70, 7,25 kg (15,98 lb), 70x70, 9,4 kg (20.72 lb).

Table pour usage extérieur, injectée en polypropylène avec pied central emboîté et grande stabilité. Disponible en ronde de Ø70 cm et carrée de 70x70 cm. Poids net Ø70, 7,25 kg, 70x70, 9,4 kg.

Blanco | White | Blanc

Antracita | Antracite | Antracite

Ø 70 cm | Ø 27.56 in  
H 73 cm | H 28.74 in  
W 70 cm | W 27.56 in  
L 70 cm | L 27.56 in  
H 73 cm | H 28.74 in

Esculapi Test Certificates: EN 581 PUBLIC



STD units	Packaging dim. (cm)	M3/ pack	NW units (kg)	Units Container 20'	Units Container 40'	Units Container HC	Units Truck 70m³	Units Truck 100m³
1	100x100x235	2,35	7,25	168	357	408	456	504
30	140X90X222	2,80	7,25	300	630	720	-720	810

# BANYOLES

Mesa | Table | Table



Mesa de polipropileno con pie central embutido. Peso neto 6,6 kg.

Polypropylene table with pressure-fitted pedestal. Net weight 6,6 kg (14.55 lb).

Table pour guéridon de polypropylène avec pied central emboîté. Poids net 6,6 kg.

Blanco | White | Blanc

Antracita | Antracite | Antracite

Ø 60 cm | Ø 23.62 in  
H 73 cm | H 28.74 in

STD units	Packaging dim. (cm)	M3/ pack	NW units (kg)	Units Container 20'	Units Container 40'	Units Container HC	Units Truck 70m³	Units Truck 100m³
1	161X15X77	0,07	6,65	420	840	840	1.000	-
30	120X90X220	2,38	6,65	300	660	660	900	960

# 0769

Mesa con estructura de acero termolacado en pintura de poliéster. Tubo de 22 ø. Tapa de madera de pino en los diferentes acabados según tarifa.  
 Table with steel structure thermo-lacquered in polyester paint. Tube of 22 ø. Wooden table top in the different finishes according to catalog.



ESTRUCTURA FRAMEWORK	CÓDIGO CODE
Pintura color blanco text. Colour white textured paint.	07691 <b>1</b>
Pintura color crema text. Colour cream textured paint.	07694 <b>4</b>
Pintura color burdeos text. Bordeaux colour painted.	0769UTX <b>UTX</b>
Pintura color chocolate. Chococolate color painted.	0769Q <b>Q</b>
Pintura color gris grafito. Gray graphite colour painted.	0769R <b>R</b>
Pintura color negro text. Colour black textured paint.	07692 <b>2</b>

**MADERA**  
WOOD

88.00 70  
70

**Madera Pino** Wood - M

MPG MPO **MPT** MPK MPB

Interiores/cubierto Indoor / Cover

T 75 T 70X70 8,6 00 0,00



# 0869

Mesa con estructura de acero termolacado en pintura de poliéster. Tubo de 22 ø. Tapa de madera de pino en los diferentes acabados según tarifa.  
 Table with steel structure thermo-lacquered in polyester paint. Tube of 22 ø. Wooden table top in the different finishes according to catalog.



ESTRUCTURA FRAMEWORK	CÓDIGO CODE
Pintura color blanco text. Colour white textured paint.	08691 <b>1</b>
Pintura color crema text. Colour cream textured paint.	08694 <b>4</b>
Pintura color burdeos text. Bordeaux colour painted.	0869UTX <b>UTX</b>
Pintura color chocolate. Chococolate color painted.	0869Q <b>Q</b>
Pintura color gris grafito. Gray graphite colour painted.	0869R <b>R</b>
Pintura color negro text. Colour black textured paint.	08692 <b>2</b>

**MADERA**  
WOOD

110.00 80  
80

**Madera Pino** Wood - M

MPG MPO **MPT** MPK MPB

Interiores/cubierto Indoor / Cover

T 75 T 80X80 9,4 00 0,00

# 0779

Mesa con estructura de acero termolacado en pintura de poliéster. Tubo de 22 ø. Tapa de madera de pino en los diferentes acabados según tarifa.  
 Table with steel structure thermo-lacquered in polyester paint. Tube of 22 ø. Wooden table top in the different finishes according to catalog.



ESTRUCTURA FRAMEWORK	CÓDIGO CODE
Pintura color blanco text. Colour white textured paint.	07791 <b>1</b>
Pintura color crema text. Colour cream textured paint.	07794 <b>4</b>
Pintura color burdeos text. Bordeaux colour painted.	0779UTX <b>UTX</b>
Pintura color chocolate. Chococolate color painted.	0779Q <b>Q</b>
Pintura color gris grafito. Gray graphite colour painted.	0779R <b>R</b>
Pintura color negro text. Colour black textured paint.	07792 <b>2</b>

**MADERA**  
WOOD

125.00 70  
110

**Madera Pino** Wood - M

MPG MPO **MPT** MPK MPB

Interiores/cubierto Indoor / Cover

T 75 T 110 x 70 12 00 0,00

# 1669

Mesa con estructura de acero termolacado en pintura de poliéster. Tubo de 22 ø. Tapa de madera de pino en los diferentes acabados según tarifa.  
 Table with steel structure thermo-lacquered in polyester paint. Tube of 22 ø. Wooden table top in the different finishes according to catalog.



ESTRUCTURA FRAMEWORK	CÓDIGO CODE
Pintura color blanco text. Colour white textured paint.	16691 <b>1</b>
Pintura color crema text. Colour cream textured paint.	16694 <b>4</b>
Pintura color burdeos text. Bordeaux colour painted.	1669UTX <b>UTX</b>
Pintura color chocolate. Chococolate color painted.	1669Q <b>Q</b>
Pintura color gris grafito. Gray graphite colour painted.	1669R <b>R</b>
Pintura color negro text. Colour black textured paint.	16692 <b>2</b>

**MADERA**  
WOOD

118.00 60  
60

**Madera Pino** Wood - M

MPG MPO **MPT** MPK MPB

Interiores/cubierto Indoor / Cover

T 110 T 60X60 8,3 - -

# 0777- 0787- 0788

Mesa con estructura de acero, pintado en aluminio bicapa con tubo de 28 mm. Tapa en los diferentes acabados.  
Table with steel structure painted in aluminium bilayer with pipe of 28 mm. Cover in different finishes.



ESTRUCTURA FRAMEWORK	CÓDIGO CODE	MELAMINA	COMPACTO	COMPACTO D
		MELAMINE	COMPACT	DECO COMPACT
0777 Pintado en aluminio bicapa, o consultar colores <i>Painted in aluminium bilayer or see colors.</i>	0777L	58.00	88.00	94.00

T 71 T 70X70 10,28 33 2,320 70

Apilable Stackable

ESTRUCTURA FRAMEWORK	CÓDIGO CODE	MELAMINA	COMPACTO	COMPACTO D
		MELAMINE	COMPACT	DECO COMPACT
0787 Pintado en aluminio bicapa, o consultar colores <i>Painted in aluminium bilayer or see colors.</i>	0787L	60.00	122.00	124.00
	0787B			
	07871			
	0787N			
	0787T			

T 71 T 80X80 11,50 20 2,254 80

Apilable Stackable

ESTRUCTURA FRAMEWORK	CÓDIGO CODE	COMPACTO
		COMPACT
0788 Pintado en aluminio bicapa, o consultar colores <i>Painted in aluminium bilayer or see colors.</i>	0788L	169.00
	0788B	
	07881	
	0788N	
	0788T	

T 71 T 90X90 16,15 20 2,254 90

Apilable Stackable

- Bicapa aluminizado(L)  
*Bi-coat aluminized(L)*
- Blanco (B)  
*White (B)*
- Negro (N)  
*Black (N)*
- Blanco Mate (1)  
*Mate White (1)*
- Negro texturizado (T)  
*Textured Black (T)*

**Compacto (e:10mm) Compact - C**

- CB
- C6
- CK
- CJ
- CT
- CU
- C3
- CA
- CN
- CG
- CW
- CO
- CE

**Melamina (e:19mm) Melamine - F**

- F

**Compacto decorado (e:10mm) Compact - 2**

- 2N
- 2B
- 2X

**Acero Inoxidable (e:21mm) Stainless Steel - XX**

- XX



Blanco



Marfil



Crema



Naranja



Rojo



Burdeos



Pistacho



Azul



Negro



Wenge



Nogal



Magic Negro



Gris



Roble



Compacto Inox



Magic Blanco



Melamina





Sólo apto para tapas de material compacto

## Ceniceros Integrados

Evita tener ceniceros sobre las mesas. Te ofrecemos la posibilidad de incorporar un cenicero metálico en las nuevas mesas que instales en tu terraza. Sencillo, elegante y fácil de vaciar. Es un complemento perfecto para las zonas de fumadores.

*Its avoids to have ashtrays on the tables. We offer you the possibility to incorporate a metallic ashtray in the new tables installed in your terrace. Simple, elegant and easy to empty. It is a perfect complement for the smokers zones.*

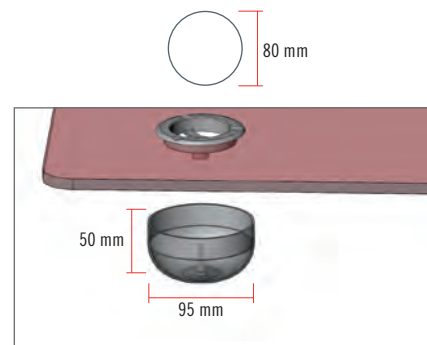

**SISTEMA DE VACIADO**  
Por la parte de abajo de la tapa desroscar el recipiente para vaciar.



Serie 777



Serie 771



Serie 1017



Serie 1018



Serie 1086



Serie 1088



Serie 654



Serie 693

### EJEMPLO / EXAMPLE

ESTRUCTURA FRAMEWORK	CÓDIGO CODE	COMPACTO COMPACT
Bicapa aluminizado Bi-coat Aluminized	4000L	0.00
<b>4000LCUC4</b>		
MATERIAL MATERIAL	CÓDIGO CODE	PV AÑADIR PV ADD
CENICERO Aluminio Aluminium	C4	0.00

**Compacto Compact - C**  
**CU**

MATERIAL MATERIAL	CÓDIGO CODE	PV A AÑADIR A LA MESA PV ADD A TABLE
CENICERO Aluminio Aluminium	C4	9.00

*Cuidamos los acabados para ofrecerte un producto de calidad para tu negocio.*



# 0661

Mesa con estructura de doble tubo de aluminio anodizado, con tubo de 25 mm. Tapa en los diferentes acabados.  
Table with double pipe structure of aluminium anodized with pipe of 25 mm. Cover in different finishes.



ESTRUCTURA FRAMEWORK	CÓDIGO CODE	ACERO INOX STAINLESS STEEL	COMPACTO COMPACT	COMPACTO D DECO COMPACT
Anodizado Anodized	0661Z	69.00	85.00	93.00

T 75 T 60 5,150 20 1,010

Apilable Stackable

Compacto (e:10mm) Compact - C

CB C6 CK CJ CT CU C3 CA CN  
CG CW CO CE

Compacto decorado (e:10mm) Compact - 2

2N 2B 2X

Acero Inoxidable (e:21mm) Stainless Steel - XX



# 0775 - 0875 - 0975

Mesa con estructura de acero pintado en diferentes acabados, con tubo ovalado de 15x20 mm. Tapa en los diferentes acabados.  
Table with steel structure painted in different finishes with oval pipe 15x20 mm. Cover in different finishes.



ESTRUCTURA FRAMEWORK	CÓDIGO CODE	COMPACTO D DECO COMPACT	COMPACTO COMPACT	REGRESADO THICKNESS	MADERA LAC. LACQUERED W.
0775 Pintado en aluminio bicapa, o consultar colores Painted in aluminium bilayer or see colors.	0775L	105.00	103.50	121.00	162.00

T 75 T 70X70 12,00 25 2,320

# 0771 - 0881

Mesa con estructura de doble tubo de aluminio anodizado, con tubo de 25 mm. Tapa en los diferentes acabados.  
Table with double pipe structure of aluminium anodized with pipe of 25 mm. Cover in different finishes.



ESTRUCTURA FRAMEWORK	CÓDIGO CODE	ACERO INOX STAINLESS STEEL	COMPACTO COMPACT	COMPACTO D DECO COMPACT
0771 Anodizado Anodized	0771Z	105.00	120.00	130.00

T 75 T 70X70 6,70 24 2,121

Apilable Stackable

ESTRUCTURA FRAMEWORK	CÓDIGO CODE	ACERO INOX STAINLESS STEEL	COMPACTO COMPACT	COMPACTO D DECO COMPACT
0881 Anodizado Anodized	0881Z	115.00	135.00	148.00

T 75 T 80X80 7,6 24 2,121

Apilable Stackable

Compacto (e:10mm) Compact - C

CB C6 CK CJ CT CU C3 CA CN  
CG CW CO CE

Compacto decorado (e:10mm) Compact - 2

2N 2B 2X

Acero Inoxidable (e:21mm) Stainless Steel - XX



ESTRUCTURA FRAMEWORK	CÓDIGO CODE	COMPACTO COMPACT	REGRESADO THICKNESS
0875 Pintado en aluminio bicapa, o consultar colores Painted in aluminium bilayer or see colors.	0875L	135.50	144.00

T 75 T 80X80 14,00 20 2,254



ESTRUCTURA FRAMEWORK	CÓDIGO CODE	COMPACTO COMPACT	REGRESADO THICKNESS
0975 Pintado en aluminio bicapa, o consultar colores Painted in aluminium bilayer or see colors.	0975L	159.60	170.00

T 75 T 90X90 17,00 20 2,254

Compacto (e:10mm) Compact - C

CB C6 CK CJ CT CU C3 CA CN  
CG CW CO CE

Regresado (e:40mm) Thicknesser (e:40mm) - G

GB GN GZ GW

Madera (e:22mm) Wood - M

MH MF MO MW

Compacto decorado (e:10mm) Compact - 2

2N 2B 2X



# 0774

EGEO · Mesa con estructura de acero pintada en aluminio bicapa, negro o marfil de 30x30 mm. Tapa de compacto.  
Table with painted steel structure with tube of 30x30 mm. Cover in compact.



ESTRUCTURA FRAMEWORK	CÓDIGO CODE	COMPACTO COMPACT
Pintado en color aluminio, negro o marfil <i>Painted in aluminium bilayer or see colors.</i>	0774L	106.70

T 75 T 70x70 13,4 25 2,320 70

Compacto Compact · C

CB	C6	CK	CJ	CT	CU	C3	CA	CN	CG	CW	CO	CE
----	----	----	----	----	----	----	----	----	----	----	----	----

	Apilable Stackable
	Interiores Indoor
	Útil para exteriores Outdoor

# 0784

EGEO · Mesa con estructura de acero pintada en aluminio bicapa, negro o marfil de 30x30 mm. Tapa de compacto.  
Table with painted steel structure with tube of 30x30 mm. Cover in compact.



ESTRUCTURA FRAMEWORK	CÓDIGO CODE	COMPACTO COMPACT
Pintado en color aluminio, negro o marfil <i>Painted in aluminium bilayer or see colors.</i>	0784L	152.80

T 75 T 80x80 15 25 2,320 80

Compacto Compact · C

CB	C6	CK	CJ	CT	CU	C3	CA	CN	CG	CW	CO	CE
----	----	----	----	----	----	----	----	----	----	----	----	----

	Apilable Stackable
	Interiores Indoor
	Útil para exteriores Outdoor

# 0785

EGEO · Mesa con estructura de acero pintada en aluminio bicapa, negro o marfil de 30x30 mm. Tapa de compacto.  
Table with painted steel structure with tube of 30x30 mm. Cover in compact.



ESTRUCTURA FRAMEWORK	CÓDIGO CODE	COMPACTO COMPACT
Pintado en color aluminio, negro o marfil <i>Painted in aluminium bilayer or see colors.</i>	0785L	205.00

T 75 T 90x90 15,42 25 2,320 90

Compacto Compact · C

CB	C6	CK	CJ	CT	CU	C3	CA	CN	CG	CW	CO	CE
----	----	----	----	----	----	----	----	----	----	----	----	----

# 4002 - 4003 - 4004

Mesa con estructura de aluminio pintado con diferentes acabados y tubo de 40x40, tapa de compacto.  
Table with painted in aluminium structure with tube of 40x40 mm. Cover in compact.



ESTRUCTURA FRAMEWORK	CÓDIGO CODE	COMPACTO COMPACT
4002 Pintado en aluminio bicapa, o consultar colores <i>Painted in aluminium bilayer or see colors.</i>	4002L	207.90

T 75 T 70x70 12,5 15 2,880 70

ESTRUCTURA FRAMEWORK	CÓDIGO CODE	COMPACTO COMPACT
4003 Pintado en aluminio bicapa, o consultar colores <i>Painted in aluminium bilayer or see colors.</i>	4003L	281.40

T 75 T 80x80 14,00 15 2,880 80

ESTRUCTURA FRAMEWORK	CÓDIGO CODE	COMPACTO COMPACT
4004 Pintado en aluminio bicapa, o consultar colores <i>Painted in aluminium bilayer or see colors.</i>	4004L	336.00

T 75 T 90x90 15,00 15 2,880 90

Compacto Compact · C

CB	C6	CK	CJ	CT	CU	C3	CA	CN	CG	CW	CO	CE
----	----	----	----	----	----	----	----	----	----	----	----	----

	Apilable Stackable
	Sólo en interiores Indoor
	Útil para exteriores Outdoor

# 4200 - 4205 - 4210

Mesa con estructura de aluminio pintado con diferentes acabados y tubo de 40x40, tapa de compacto encastrado.  
Table with coated aluminium frame, different finishes, in 40x40mm tube. Cover made of embedded compact.



ESTRUCTURA FRAMEWORK	CÓDIGO CODE	COMPACTO COMPACT
4200 Pintado en aluminio bicapa, o consultar colores <i>Painted in aluminium bilayer or see colors.</i>	4200L	207.90

T 75 T 70x70 13,00 15 2,600 70

ESTRUCTURA FRAMEWORK	CÓDIGO CODE	COMPACTO COMPACT
4205 Pintado en aluminio bicapa, o consultar colores <i>Painted in aluminium bilayer or see colors.</i>	4205L	281.40

T 75 T 80x80 14,00 15 2,880 80

ESTRUCTURA FRAMEWORK	CÓDIGO CODE	COMPACTO COMPACT
4210 Pintado en aluminio bicapa, o consultar colores <i>Painted in aluminium bilayer or see colors.</i>	4210L	336.00

T 75 T 90x90 15,00 15 2,920 90

Compacto Compact · C

CB	C6	CK	CJ	CT	CU	C3	CA	CN	CG	CW	CO	CE
----	----	----	----	----	----	----	----	----	----	----	----	----

	Apilable Stackable
	Sólo en interiores Indoor
	Útil para exteriores Outdoor

# 0660 - 0667 - 0695

Mesa con estructura de acero pintado en aluminio bicapa o blanco, con tubo de 28 mm. Tapa en los diferentes acabados.  
Table with steel structure painted aluminium bilayer or whit, with pipe of 28 mm. Cover in different finishes.



ESTRUCTURA FRAMEWORK	CÓDIGO CODE	MELAMINA MELAMINE	COMPACTO COMPACT
		0660	Pintado en aluminio bicapa, o consultar colores Painted in aluminium bilayer or see colors.

T 75 T 60    7,000    30    1,305    60



ESTRUCTURA FRAMEWORK	CÓDIGO CODE	MELAMINA MELAMINE	COMPACTO COMPACT
		0667	Pintado en aluminio bicapa, o consultar colores Painted in aluminium bilayer or see colors.

T 75 T 70    8,000    20    1,010    70



ESTRUCTURA FRAMEWORK	CÓDIGO CODE	MELAMINA MELAMINE	COMPACTO COMPACT
		0695	Pintado en aluminio bicapa, o consultar colores Painted in aluminium bilayer or see colors.

T 75 T 80    10,00    25    2,120    80

Interiores/cubierto *Indoor/cover*  
Útil para exteriores *Outdoor*

**Compacto (e:10mm) Compact - C**  
CB C6 CK CJ CT CU C3 CA CN  
CG CW CO CE

**Compacto decorado (e:10mm) Compact - 2**  
2N 2B 2X

**Melamina (e:19mm) Melamine - F**  
F

# 0607 - 0888 - 0829

Mesa con estructura de acero pintado en los diferentes acabados de pintura o cromo. Tapa en los diferentes acabados. Patas de tubo redondo de ø40.  
Table with steel structure painted in different finishes or chrome. Cover in different finishes.



ARMAZÓN:

Bicapa aluminizado(L)  
Bi-coat aluminized(L)    Blanco (B)  
White (B)  
Negro (N)  
Black (N)



PATAS:

Bicapa aluminizado(L)  
Bi-coat aluminized(L)    Negro (N)  
Black (N)  
Cromo (C)  
Chrome (C)    Blanco (B)  
White (B)

Interiores/cubierto *Indoor/cover*  
Útil para exteriores *Outdoor*

**Compacto (e:10mm) Compact - C**

CB C6 CK CJ CT CU C3 CA CN  
CG CW CO CE

**Melamina (e:19mm) Melamine - F**

F

ESTRUCTURA FRAMEWORK	CÓDIGO CODE	MELAMINA MELAMINE	COMPACTO COMPACT
		0607	Estructura en bicapa aluminizado o negro y patas de acero pintadas en bicapa aluminizado o negro Bilayer aluminized or black frame and bi-coat aluminized or black steel tube
	Estructura en Blanco y patas de aluminio pintadas en blanco White frame and white painted in aluminium tube	0607B	103.95 149.10
	Estructura en bicapa aluminizado y patas cromadas Bilayer aluminized frame and chromed tube	0607C	97.00 140.00

T 75 T 70X70    9,800    1    0,060    70

ESTRUCTURA FRAMEWORK	CÓDIGO CODE	MELAMINA MELAMINE	COMPACTO COMPACT
		0888	Estructura en bicapa aluminizado o negro y patas de acero pintadas en bicapa aluminizado o negro Bi-coat aluminized or black frame and bi-coat aluminized or black steel tube
	Estructura en Blanco y patas de aluminio pintadas en blanco White frame and white painted in aluminium tube	0888B	106.05 170.10
	Estructura en bicapa aluminizado y patas cromadas Bi-coat aluminized frame and chromed tube	0888C	103.95 168.00

T 75 T 80X80    12,50    1    0,078    80

ESTRUCTURA FRAMEWORK	CÓDIGO CODE	MELAMINA MELAMINE	COMPACTO COMPACT
		0829	Estructura en bicapa aluminizado o negro y patas de acero pintadas en bicapa aluminizado o negro Bi-coat aluminized or black frame and bi-coat aluminized or black steel tube
	Estructura en Blanco y patas de aluminio pintadas en blanco White frame and white painted in aluminium tube	0829B	141.75 233.10
	Estructura en bicapa aluminizado y patas cromadas Bi-coat aluminized frame and chromed tube	0829C	137.55 229.95

T 75 T 120X80    18,00    1    0,124    80

## 4000 - 4005

Mesa con estructura de acero pintado en los diferentes acabados de pintura o acero inoxidable, con tubo de 40x40 mm. Tapa en los diferentes acabados.  
 Table with steel structure painted in different finishes or stainless steel with pipe of 40x40 mm. Cover in different finishes.



ESTRUCTURA FRAMEWORK	CÓDIGO CODE	COMPACTO	COMPACTO D	CRISTAL TR.	CRISTAL OP.	CRISTAL COL
		COMPACT	COMPACT DEC	COMPACT	COMPACT	COMPACT
4000 Pintado en aluminio bicapa, o consultar colores <i>Painted in aluminium bilayer or see colors.</i>	4000L	160.65	159.60	188.00	195.00	209.00
	40001					
	4000T					
Acero Inoxidable <i>Stainless Steel</i>	4000X	263.55	●	297.00	301.00	314.00

T 75 T 70X70 16,50 1 0,076 70



ESTRUCTURA FRAMEWORK	CÓDIGO CODE	COMPACTO	COMPACTO D	CRISTAL TR.	CRISTAL OP.	CRISTAL COL
		COMPACT	COMPACT DEC	COMPACT	COMPACT	COMPACT
4005 Pintado en aluminio bicapa, o consultar colores <i>Painted in aluminium bilayer or see colors.</i>	4005L	181.00	193.20	212.00	239.40	262.00
	40051					
	4005T					
Acero Inoxidable <i>Stainless Steel</i>	4005X	340.00	●	262.00	393.00	419.00

T 75 T 80X80 22,40 1 0,087 80

## 4010 - 4015



ESTRUCTURA FRAMEWORK	CÓDIGO CODE	COMPACTO	COMPACTO D	CRISTAL TR.	CRISTAL OP.	CRISTAL COL
		COMPACT	COMPACT DEC	COMPACT	COMPACT	COMPACT
4010 Pintado en aluminio bicapa, o consultar colores <i>Painted in aluminium bilayer or see colors.</i>	4010L	208.00	242.00	272.00	316.00	327.00
	40101					
	4010T					
Acero Inoxidable <i>Stainless Steel</i>	4010X	361.00	●	420.00	453.00	475.00

T 75 T 110X70 23,60 1 0,133 70

ESTRUCTURA FRAMEWORK	CÓDIGO CODE	COMPACTO	COMPACTO D	CRISTAL TR.	CRISTAL OP.	CRISTAL COL
		COMPACT	COMPACT DEC	COMPACT	COMPACT	COMPACT
4015 Pintado en aluminio bicapa, o consultar colores <i>Painted in aluminium bilayer or see colors.</i>	4015L	223.65	251.00	300.00	340.00	365.00
	40151					
	4015T					
Acero Inoxidable <i>Stainless Steel</i>	4015X	379.00	●	464.00	505.00	530.00

T 75 T 120X80 24,70 1 0,520 80

Compacto (e:10mm) Compact - C



Compacto decorado (e:10mm) Compact - 2



Cristal (e:10mm) Crystal (e:10mm) - Q



## 4027 - 4028 - 4029

Mesa con estructura de acero pintado en los diferentes acabados de pintura o acero inoxidable, con tubo de 40x40 mm. Tapa en los diferentes acabados.  
 Table with steel structure painted in different finishes or stainless steel with pipe of 40x40 mm. Cover in different finishes.



ESTRUCTURA FRAMEWORK	CÓDIGO CODE	COMPACTO
		COMPACT
4027 Pintado en aluminio bicapa, o consultar colores <i>Painted in aluminium bilayer or see colors.</i>	4027L	268.00
	40271	
Acero Inoxidable <i>Stainless Steel</i>	4027X	442.00

T 75 T 140X80 25,72 1 0,380 80



ESTRUCTURA FRAMEWORK	CÓDIGO CODE	COMPACTO
		COMPACT
4028 Pintado en aluminio bicapa, o consultar colores <i>Painted in aluminium bilayer or see colors.</i>	4028L	297.00
	40281	
Acero Inoxidable <i>Stainless Steel</i>	4028X	475.00

T 75 T 160X80 30,60 1 0,400 80



ESTRUCTURA FRAMEWORK	CÓDIGO CODE	COMPACTO
		COMPACT
4029 Pintado en aluminio bicapa, o consultar colores <i>Painted in aluminium bilayer or see colors.</i>	4029L	324.00
	40291	
Acero Inoxidable <i>Stainless Steel</i>	4029X	511.00

T 75 T 180X80 33,76 1 0,520 80

Interiores/cubierto *Indoor/cover*

Compacto (e:10mm) Compact - C





# 4021 - 4022 - 4023 - 4024

Mesa con estructura de acero pintado en los diferentes acabados de pintura o acero inoxidable, con tubo de 40x40 mm. Tapa en compacto.

Table with steel structure painted in different finishes or Stainless Steel with pipe of 40x40 mm. Cover in compact.



ESTRUCTURA FRAMEWORK	CÓDIGO CODE
Pintado en aluminio bicapa, o consultar colores <i>Painted in aluminium bilayer or see colors.</i>	4021L 40211
Acero Inoxidable <i>Stainless Steel</i>	4021X

COMPACTO COMPACT
184.00
333.00

T 75	T 120X45	kg 18,00	1	0,158
------	----------	----------	---	-------

45	120
----	-----

Bicapa aluminizado(L)  Blanco Mate (1)  
*Bi-coat aluminized(L) Mate White (1)*



ESTRUCTURA FRAMEWORK	CÓDIGO CODE
Pintado en aluminio bicapa, o consultar colores <i>Painted in aluminium bilayer or see colors.</i>	4022L 40221
Acero Inoxidable <i>Stainless Steel</i>	4022X

COMPACTO COMPACT
208.00
364.00

T 75	T 140X45	kg 22,00	1	0,260
------	----------	----------	---	-------

45	140
----	-----



ESTRUCTURA FRAMEWORK	CÓDIGO CODE
Pintado en aluminio bicapa, o consultar colores <i>Painted in aluminium bilayer or see colors.</i>	4023L 40231
Acero Inoxidable <i>Stainless Steel</i>	4023X

COMPACTO COMPACT
216.00
383.00

T 75	T 160X45	kg 26,00	1	0,320
------	----------	----------	---	-------

45	160
----	-----



ESTRUCTURA FRAMEWORK	CÓDIGO CODE
Pintado en aluminio bicapa, o consultar colores <i>Painted in aluminium bilayer or see colors.</i>	4024L 40241
Acero Inoxidable <i>Stainless Steel</i>	4024X

COMPACTO COMPACT
226.00
402.00

T 75	T 180X45	kg 31,00	1	0,380
------	----------	----------	---	-------

45	180
----	-----

Interiores *Indoor*  
 Útil para exteriores *Outdoor*

Compacto (e:10mm) *Compact - C*  

CB	C6	CK	CJ	CT	CU	C3	CA	CN
CG	CW	CO	CE					

## EJEMPLOS DE UTILIZACIÓN

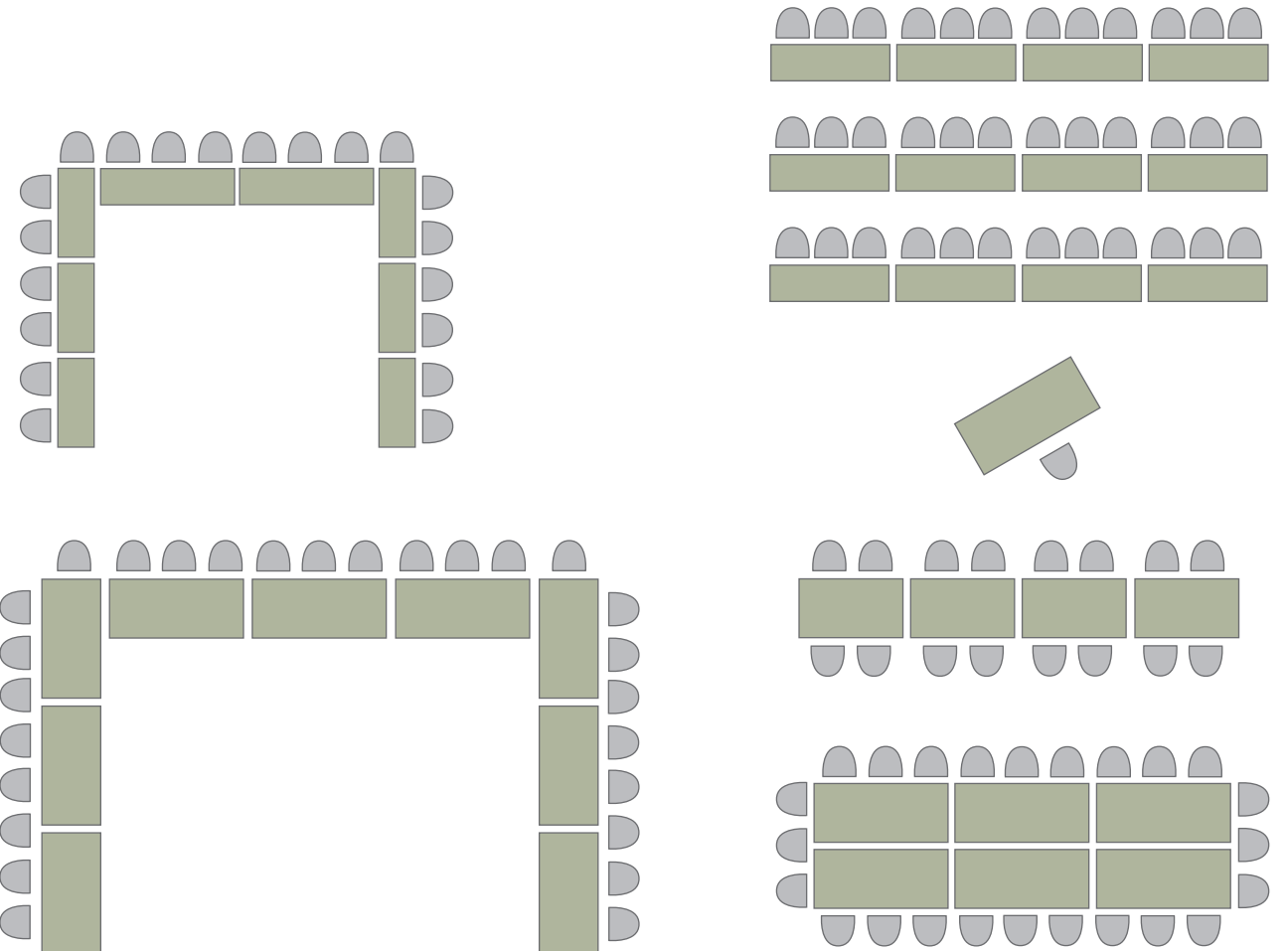

## 4001

Mesa con estructura de acero pintado en los diferentes acabados de pintura, con tubo de 40x40 mm. Tapa en compacto.  
Table with steel structure painted in different finishes with pipe of 40x40 mm. Cover in compact.



ESTRUCTURA FRAMEWORK	CÓDIGO CODE
Pintado en aluminio bicapa, o consultar colores <i>Painted in aluminium bilayer or see colors.</i>	4001L

COMPACTO COMPACT
161.00

T 110	T 60X60	kg 15,50	1	0,211
-------	---------	----------	---	-------

60	60
----	----

Interiores *Indoor*  
 Útil para exteriores *Outdoor*

Compacto (e:10mm) *Compact - C*  

CB	C6	CK	CJ	CT	CU	C3	CA	CN
CG	CW	CO	CE					

# 1094 - 1093

Mesa con estructura de acero, pintado en aluminio bicapa con tubo de 60 X 60 mm. Tapa en compacto.  
Table with steel structure painted in aluminium bilayer with pipe of 60 X 60 mm. Cover in compact.



ESTRUCTURA FRAMEWORK	CÓDIGO CODE	COMPACTO	
		COMPACT	COMPACTO DECO COMPACT DECO
1094 Pintado en aluminio bicapa, o consultar colores <i>Painted in aluminium bilayer or see colors.</i>	1094L	176.00	183.00

T 75 T 70 12,7 1 0,037 70

ESTRUCTURA FRAMEWORK	CÓDIGO CODE	COMPACTO	
		COMPACT	COMPACTO DECO COMPACT DECO
1093 Pintado en aluminio bicapa, o consultar colores <i>Painted in aluminium bilayer or see colors.</i>	1093L	176.00	183.00

T 75 T 70X70 14,2 1 0,037 70

# 1098 - 1099



ESTRUCTURA FRAMEWORK	CÓDIGO CODE	COMPACTO	
		COMPACT	COMPACTO DECO COMPACT DECO
1098 Pintado en aluminio bicapa, o consultar colores <i>Painted in aluminium bilayer or see colors.</i>	1098L	193.00	200.00

T 75 T 80 14,86 1 0,037 80

ESTRUCTURA FRAMEWORK	CÓDIGO CODE	COMPACTO	
		COMPACT	COMPACTO DECO COMPACT DECO
1099 Pintado en aluminio bicapa, o consultar colores <i>Painted in aluminium bilayer or see colors.</i>	1099L	193.00	200.00

T 75 T 80X80 16,36 1 0,037 80

# 1092 - 1092/1



ESTRUCTURA FRAMEWORK	CÓDIGO CODE	COMPACTO COMPACT	
1092 Pintado en aluminio bicapa, o consultar colores <i>Painted in aluminium bilayer or see colors.</i>	1092L	159.60	60  15
1092 Pintado en aluminio bicapa, o consultar colores <i>Painted in aluminium bilayer or see colors.</i>	1092L	159.60	60  16
1092/1 Pintado en aluminio bicapa, o consultar colores <i>Painted in aluminium bilayer or see colors.</i>	1092/1L	180.60	70  16,3
1092/1 Pintado en aluminio bicapa, o consultar colores <i>Painted in aluminium bilayer or see colors.</i>	1092/1L	180.60	70  17,8

Interiores Indoor Útil para exteriores Outdoor 110 1 0,054

# 1084 - 1083 - 1088 - 1089

Mesa con estructura de acero, pintado en aluminio bicapa con tubo de 65 mm. Tapa en los diferentes acabados.  
Table with steel structure painted aluminium bilayer with pipe of 65 mm. Cover in different finishes.



ESTRUCTURA FRAMEWORK	CÓDIGO CODE	COMPACTO		
		COMPACT	COMPACTO DECO COMPACT DECO	
1084 Pintado en aluminio bicapa, o consultar colores <i>Painted in aluminium bilayer or see colors.</i>	1084L	142.80	152.25	60  12,2
1083 Pintado en aluminio bicapa, o consultar colores <i>Painted in aluminium bilayer or see colors.</i>	1083L	142.80	152.25	60  13,2
1088 Pintado en aluminio bicapa, o consultar colores <i>Painted in aluminium bilayer or see colors.</i>	1088L	146.00	154.35	70  13,5
1089 Pintado en aluminio bicapa, o consultar colores <i>Painted in aluminium bilayer or see colors.</i>	1089L	146.00	154.35	70  15

T 75 1 0,037

# 1087 - 1086



ESTRUCTURA FRAMEWORK	CÓDIGO CODE	COMPACTO		
		COMPACT	COMPACTO DECO COMPACT DECO	
1087 Pintado en aluminio bicapa, o consultar colores <i>Painted in aluminium bilayer or see colors.</i>	1087L	143.85	153.30	60  18
1086 Pintado en aluminio bicapa, o consultar colores <i>Painted in aluminium bilayer or see colors.</i>	1086L	147.00	156.00	70  19,3

T 110 1 0,037

Interiores Indoor Útil para exteriores Outdoor

Compacto (e:10mm) Compact - C

CB C6 CK CJ CT CU C3 CA CN  
CG CW CO CE

Compacto decorado (e:10mm) Compact - 2

2N 2B 2X





# 1041 - 1042

Mesa con estructura de acero, pintado en aluminio bicapa con tubo de 65 mm. Tapa en los diferentes acabados.  
Table with steel structure painted aluminium bilayer with pipe of 65 mm. Cover in different finishes.



	ESTRUCTURA FRAMEWORK	CÓDIGO CODE	COMPACTO COMPACT	COMPACTO DECO COMPACT DECO	ESTRATIFICADO STRATIFIED	
1041	Pintado en aluminio bicapa, o consultar colores <i>Painted in aluminium bilayer or see colors.</i>	1041L	140.00	149.50	•	60
1041	Pintado en aluminio bicapa, o consultar colores <i>Painted in aluminium bilayer or see colors.</i>	1041L	140.00	149.50	140.00	60 60
1042	Pintado en aluminio bicapa, o consultar colores <i>Painted in aluminium bilayer or see colors.</i>	1042L	149.00	159.00	•	70
1042	Pintado en aluminio bicapa, o consultar colores <i>Painted in aluminium bilayer or see colors.</i>	1042L	149.00	159.00	149.00	70 70

T 75 15,00 1 0,037

# 1043 - 1044



	ESTRUCTURA FRAMEWORK	CÓDIGO CODE	COMPACTO COMPACT	COMPACTO DECO COMPACT DECO	ESTRATIFICADO STRATIFIED	
1043	Pintado en aluminio bicapa, o consultar colores <i>Painted in aluminium bilayer or see colors.</i>	1043L	135.00	144.00	•	60
1043	Pintado en aluminio bicapa, o consultar colores <i>Painted in aluminium bilayer or see colors.</i>	1043L	135.00	144.00	135.00	60 60
1044	Pintado en aluminio bicapa, o consultar colores <i>Painted in aluminium bilayer or see colors.</i>	1044L	144.00	153.00	•	70
1044	Pintado en aluminio bicapa, o consultar colores <i>Painted in aluminium bilayer or see colors.</i>	1044L	144.00	153.00	144.00	70 70

T 75 15,60 1 0,037

# 1045 - 1046



	ESTRUCTURA FRAMEWORK	CÓDIGO CODE	COMPACTO COMPACT	COMPACTO DECO COMPACT DECO	ESTRATIFICADO STRATIFIED	
1045	Pintado en aluminio bicapa, o consultar colores <i>Painted in aluminium bilayer or see colors.</i>	1045L	140.00	150.00	•	60
1045	Pintado en aluminio bicapa, o consultar colores <i>Painted in aluminium bilayer or see colors.</i>	1045L	140.00	150.00	140.00	60 60
1046	Pintado en aluminio bicapa, o consultar colores <i>Painted in aluminium bilayer or see colors.</i>	1046L	149.00	159.00	•	70
1046	Pintado en aluminio bicapa, o consultar colores <i>Painted in aluminium bilayer or see colors.</i>	1046L	149.00	159.00	149.00	70 70

T 75 12,80 1 0,037

Interiores *Indoor*  
 Útil para exteriores *Outdoor*

Estratificado *Stratified - E*

EB EU EN

Compacto decorado (e:10mm) *Compact - 2*

2N 2B 2X

Compacto (e:10mm) *Compact - C*

CB C6 CK CJ CT CU C3 CA CN  
CG CW CO CE

# 1047 - 1048

Mesa con estructura de acero, pintado en aluminio bicapa con tubo de 65 mm. Tapa en los diferentes acabados.  
Table with steel structure painted aluminium bilayer with pipe of 65 mm. Cover in different finishes.



	ESTRUCTURA FRAMEWORK	CÓDIGO CODE	COMPACTO COMPACT	COMPACTO DECO COMPACT DECO	ESTRATIFICADO STRATIFIED	
1047	Pintado en aluminio bicapa, o consultar colores <i>Painted in aluminium bilayer or see colors.</i>	1047L	140.00	149.50	•	60
1047	Pintado en aluminio bicapa, o consultar colores <i>Painted in aluminium bilayer or see colors.</i>	1047L	140.00	149.50	140.00	60 60
1048	Pintado en aluminio bicapa, o consultar colores <i>Painted in aluminium bilayer or see colors.</i>	1048L	149.50	159.00	•	70
1048	Pintado en aluminio bicapa, o consultar colores <i>Painted in aluminium bilayer or see colors.</i>	1048L	149.50	159.00	149.50	70 70

T 75 12,60 1 0,037

Interiores *Indoor*  
 Útil para exteriores *Outdoor*

# 1060 - 1061

Mesa con estructura de acero inoxidable con tubo de 65 mm. Tapa en los diferentes acabados.  
Table with stainless steel structure with pipe of 65 mm. Cover in different finishes.



	ESTRUCTURA FRAMEWORK	CÓDIGO CODE	COMPACTO COMPACT	COMPACTO DECO COMPACT DECO	ESTRATIFICADO STRATIFIED	
1060	Pintado en aluminio bicapa, o consultar colores <i>Painted in aluminium bilayer or see colors.</i>	1060X	206.00	3016.00	•	60
1060	Pintado en aluminio bicapa, o consultar colores <i>Painted in aluminium bilayer or see colors.</i>	1060X	206.00	216.00	206.00	60 60
1061	Pintado en aluminio bicapa, o consultar colores <i>Painted in aluminium bilayer or see colors.</i>	1061X	215.00	225.00	•	70
1061	Pintado en aluminio bicapa, o consultar colores <i>Painted in aluminium bilayer or see colors.</i>	1061X	215.00	225.00	215.00	70 70

T 75 20 1 0,037

Interiores *Indoor*  
 Útil para exteriores *Outdoor*

Compacto (e:10mm) *Compact - C*

CB C6 CK CJ CT CU C3 CA CN  
CG CW CO CE

Compacto decorado (e:10mm) *Compact - 2*

2N 2B 2X

Estratificado *Stratified - E*

EB EU EN

# 1016 - 1018

Mesa con estructura de acero pintado en los diferentes acabados de pintura o acero inoxidable con tubo de 80x80 mm. Tapa en los diferentes acabados.  
Table with steel structure painted in different finishes or Stainless Steel with pipe of 80x80 mm. Cover with the same finishes.



- Bicapa aluminizado(L) Bi-coat aluminized(L)
- Negro Texturizado (T) Textured Black (T)
- Blanco Mate (1) Mate White (1)

ESTRUCTURA FRAMEWORK	CÓDIGO CODE	COMPACTO	COMPACTO D	REGRUESADO	MADERA
		COMPACT	COMPACT DEC	THICKNESSER	WOOD
1016 Pintado en aluminio bicapa, o consultar colores <i>Painted in aluminium bilayer or see colors.</i>	1016L	210.00	217.00	●	251.00
	1016I				
	1016T				
Acero Inoxidable <i>Stainless Steel</i>	1016X	258.00	265.00	●	300.00

T 75 T 70 20,50 1 0,030 70

ESTRUCTURA FRAMEWORK	CÓDIGO CODE	COMPACTO	COMPACTO D	REGRUESADO	MADERA
		COMPACT	COMPACT DEC	THICKNESSER	WOOD
1018 Pintado en aluminio bicapa, o consultar colores <i>Painted in aluminium bilayer or see colors.</i>	1018L	210.00	217.00	217.00	251.00
	1018I				
	1018T				
Acero Inoxidable <i>Stainless Steel</i>	1018X	258.00	265.00	265.00	300.00

T 75 T 70x70 22,00 1 0,030 70

- Interiores/cubierto *Indoor/cover*
- Útil para exteriores *Outdoor*

# 1022 - 1024



- Bicapa aluminizado(L) Bi-coat aluminized(L)
- Negro Texturizado (T) Textured Black (T)
- Blanco Mate (1) Mate White (1)

ESTRUCTURA FRAMEWORK	CÓDIGO CODE	COMPACTO	COMPACTO D	REGRUESADO	MADERA
		COMPACT	COMPACT DEC	THICKNESSER	WOOD
1022 Pintado en aluminio bicapa, o consultar colores <i>Painted in aluminium bilayer or see colors.</i>	1022L	222.00	234.00	●	268.00
	1022I				
	1022T				
Acero Inoxidable <i>Stainless Steel</i>	1022X	273.00	285.00	●	318.00

T 75 T 80 23,80 1 0,030 80

ESTRUCTURA FRAMEWORK	CÓDIGO CODE	COMPACTO	COMPACTO D	REGRUESADO	MADERA
		COMPACT	COMPACT DEC	THICKNESSER	WOOD
1024 Pintado en aluminio bicapa, o consultar colores <i>Painted in aluminium bilayer or see colors.</i>	1024L	222.00	234.00	226.00	268.00
	1024I				
	1024T				
Acero Inoxidable <i>Stainless Steel</i>	1024X	273.00	285.00	276.00	318.00

T 75 T 80x80 24,16 1 0,030 80

- Interiores/cubierto *Indoor/cover*
- Útil para exteriores *Outdoor*

Madera (e:22mm) Wood - M

- MH MF MO MW

Regruesado (e:40mm) Thicknesser (e:40mm) - G

- GB GN GZ GW

NOTA: El Regruesado se fabrican sólo en tapa cuadrada  
NOTE: Thicknesser is manufactured in Squared top only

Compacto decorado (e:10mm) Compact - 2

- 2N 2B 2X

Compacto (e:10mm) Compact - C

- CB C6 CK CJ CT CU C3 CA CN

- CG CW CO CE

# 1073 - 1074

Mesa con estructura de acero pintado en los diferentes acabados de pintura o acero inoxidable con tubo de 80x80 mm. Tapa en los diferentes acabados.  
Table with steel structure painted in different finishes or Stainless Steel with pipe of 80x80 mm. Cover with the same finishes.



ESTRUCTURA FRAMEWORK	CÓDIGO CODE	CRISTAL TRANSP.	CRISTAL OPACO	CRISTAL COLORES
		TRANS. CRYSTAL	OPAQUE CRYSTAL	COLOURS CRYSTAL
1073 Pintado en aluminio bicapa, o consultar colores <i>Painted in aluminium bilayer or see colors.</i>	1073L	285.00	306.00	321.00
	1073I			
	1073T			
Acero Inoxidable <i>Stainless Steel</i>	1073X	339.00	361.00	376.00

T 75 T 70 23,00 1 0,030 70

ESTRUCTURA FRAMEWORK	CÓDIGO CODE	CRISTAL TRANSP.	CRISTAL OPACO	CRISTAL COLORES
		TRANS. CRYSTAL	OPAQUE CRYSTAL	COLOURS CRYSTAL
1074 Pintado en aluminio bicapa, o consultar colores <i>Painted in aluminium bilayer or see colors.</i>	1074L	305.00	331.00	347.00
	1074I			
	1074T			
Acero Inoxidable <i>Stainless Steel</i>	1074X	359.00	385.00	402.00

T 75 T 80 24,50 1 0,030 80

- Sólo en interiores *Indoor*

Cristal (e:10mm) Crystal (e:10mm) - Q

- QO QS QJ QU Q3 QN

# 1017

Mesa con estructura de acero pintado en los diferentes acabados de pintura o acero inoxidable con tubo de 80x80 mm. Tapa en los diferentes acabados.  
Table with steel structure painted in different finishes or Stainless Steel with pipe of 80x80 mm. Cover with the same finishes.

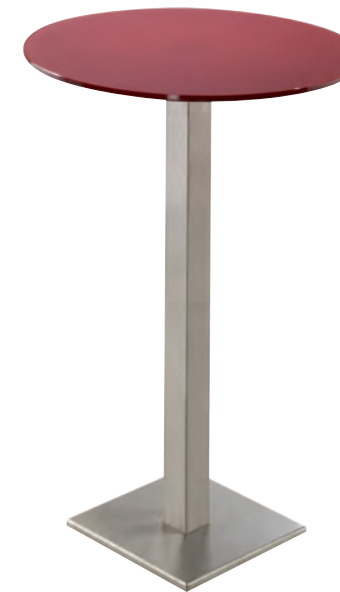

ESTRUCTURA FRAMEWORK	CÓDIGO CODE	COMPACTO	COMPACTO DECO	MADERA
		COMPACT	COMPACT DEC	WOOD
1017 Pintado en aluminio bicapa, o consultar colores <i>Painted in aluminium bilayer or see colors.</i>	1017L	201.60	206.00	238.00
	1017I			
	1017T			
Acero Inoxidable <i>Stainless Steel</i>	1017X	258.00	262.00	295.00

T 110 T 60 25,70 1 0,060 60

- Sólo en interiores *Indoor*

Compacto (e:10mm) Compact - C

- CB C6 CK CJ CT CU C3 CA CN

- CG CW CO CE

Compacto decorado (e:10mm) Compact - 2

- 2N 2B 2X

Madera (e:22mm) Wood - M

- MH MF MO MW



1019 - 1023

Mesa con estructura de acero pintado en los diferentes acabados o acero inoxidable con tubo de 80x80 mm. Tapa en los diferentes acabados.  
 Table with steel structure painted in different finishes or Stainless Steel with pipe of 80x80 mm. Cover with the same finishes.



- Bicapa aluminizado(L) Bi-coat aluminized(L)
- Negro Texturizado (T) Textured Black (T)
- Blanco Mate (1) Mate White (1)

ESTRUCTURA FRAMEWORK	CÓDIGO CODE	COMPACTO	COMPACTO D	REGRESADO	MADERA
		COMPACT	COMPACT DEC	THICKNESS	WOOD
Pintado en aluminio bicapa, o consultar colores Painted in aluminium bilayer or see colors.	1019L	335.00	362.00	344.00	377.00
	1019I				
	1019T				
Acero Inoxidable Stainless Steel	1019X	418.00	449.00	427.00	460.00

T 110 T 110x70 Kg 36,84 1 0,350 70 110

ESTRUCTURA FRAMEWORK	CÓDIGO CODE	COMPACTO	COMPACTO D	REGRESADO	MADERA
		COMPACT	COMPACT DEC	THICKNESS	WOOD
Pintado en aluminio bicapa, o consultar colores Painted in aluminium bilayer or see colors.	1023L	348.60	377.00	362.00	419.00
	1023I				
	1023T				
Acero Inoxidable Stainless Steel	1023X	431.55	460.00	445.00	502.00

T 110 T 120x80 Kg 39,70 1 0,350 80 120

1029 - 1020

Mesa con estructura de acero pintado en los diferentes acabados de pintura o acero inoxidable con tubo de 80x80 mm. Tapa en los diferentes acabados.  
 Table with steel structure painted in different finishes or Stainless Steel with pipe of 80x80 mm. Cover with the same finishes.



- Bicapa aluminizado(L) Bi-coat aluminized(L)
- Negro Texturizado (T) Textured Black (T)
- Blanco Mate (1) Mate White (1)

ESTRUCTURA FRAMEWORK	CÓDIGO CODE	COMPACTO	COMPACTO D	REGRESADO	MADERA
		COMPACT	COMPACT DEC	THICKNESS	WOOD
Pintado en aluminio bicapa, o consultar colores Painted in aluminium bilayer or see colors.	1029L	314.00	342.00	323.00	357.00
	1029I				
	1029T				
Acero Inoxidable Stainless Steel	1029X	341.00	424.00	401.00	433.00

T 75 T 110x70 Kg 36 1 0,250 70 110

ESTRUCTURA FRAMEWORK	CÓDIGO CODE	COMPACTO	COMPACTO D	REGRESADO	MADERA
		COMPACT	COMPACT DEC	THICKNESS	WOOD
Pintado en aluminio bicapa, o consultar colores Painted in aluminium bilayer or see colors.	1020L	336.00	365.00	350.00	406.00
	1020I				
	1020T				
Acero Inoxidable Stainless Steel	1020X	404.00	432.60	418.00	475.00

T 75 T 120x80 Kg 38,66 1 0,250 80 120

Madera (e:22mm) Wood - M

- MH MF MO MW

Regresado (e:40mm) Thicknesser (e:40mm) - G

- GB GN GZ GW

Compacto (e:10mm) Compact - C

- CB C6 CK CJ CT CU C3 CA CN

- CG CW CO CE

Compacto decorado (e:10mm) Compact - 2

- 2N 2B 2X

1003 - 1009

Mesa con estructura de acero pintado en los diferentes acabados de pintura o acero inoxidable con tubo de 80x80 mm. Tapa en los diferentes acabados.  
 Table with steel structure painted in different finishes or Stainless Steel with pipe of 80x80 mm. Cover with the same finishes.



- Bicapa aluminizado(L) Bi-coat aluminized(L)
- Negro Texturizado (T) Textured Black (T)
- Blanco Mate (1) Mate White (1)

ESTRUCTURA FRAMEWORK	CÓDIGO CODE	COMPACTO	COMPACTO D	REGRESADO	MADERA
		COMPACT	COMPACT DEC	THICKNESS	WOOD
Pintado en aluminio bicapa, o consultar colores Painted in aluminium bilayer or see colors.	1003L	273.00	305.00	283.00	315.00
	1003I				
	1003T				
Acero Inoxidable Stainless Steel	1003X	325.00	358.00	334.00	365.00

T 75 T 110x70 Kg 25,00 1 0,210 70 110

ESTRUCTURA FRAMEWORK	CÓDIGO CODE	COMPACTO	COMPACTO D	REGRESADO	MADERA
		COMPACT	COMPACT DEC	THICKNESS	WOOD
Pintado en aluminio bicapa, o consultar colores Painted in aluminium bilayer or see colors.	1009L	285.00	313.00	298.00	354.00
	1009I				
	1009T				
Acero Inoxidable Stainless Steel	1009X	337.00	365.00	351.00	407.00

T 75 T 120x80 Kg 28,00 1 0,210 80 120

Madera (e:22mm) Wood - M

- MH MF MO MW

Regresado (e:40mm) Thicknesser (e:40mm) - G

- GB GN GZ GW

Compacto (e:10mm) Compact - C

- CB C6 CK CJ CT CU C3 CA CN

- CG CW CO CE

Compacto decorado (e:10mm) Compact - 2

- 2N 2B 2X



# 0795 - 0797

Mesa con estructura de acero inoxidable o cromo con tubo de 76 mm. Tapa en los diferentes acabados.  
Table with stainless steel or chrome structure with pipe of 76 mm. Cover in different finishes.



ESTRUCTURA FRAMEWORK	CÓDIGO CODE	COMPACTO	COMPACTO DECO
		COMPACT	COMPACT DECO
0795 Cromado Chrome	0795C	202.00	209.00
0795 Acero Inoxidable Stainless Steel	0795X	230.00	237.00

T 75 T 60 9 1 0,135 60

ESTRUCTURA FRAMEWORK	CÓDIGO CODE	COMPACTO	COMPACTO DECO
		COMPACT	COMPACT DECO
0797 Cromado Chrome	0797C	202.00	209.00
0797 Acero Inoxidable Stainless Steel	0797X	230.00	237.00

T 75 T 60x60 10 1 0,135 60

- Interiores/cubierto Indoor/cover
- Útil para exteriores Outdoor

# 0792 - 0794

Mesa con estructura de acero inoxidable o cromo con tubo de 76 mm. Tapa en los diferentes acabados.  
Table with stainless steel or chrome structure with pipe of 76 mm. Cover in different finishes.



ESTRUCTURA FRAMEWORK	CÓDIGO CODE	COMPACTO	COMPACTO D	REGRUESADO	MADERA
		COMPACT	COMPACT DEC	THICKNESS	WOOD
0792 Cromado Chrome	0792C	217.00	224.00	•	247.00
0792 Acero Inoxidable Stainless Steel	0792X	242.00	243.00	•	271.00

T 75 T 70 10,30 1 0,077 70

ESTRUCTURA FRAMEWORK	CÓDIGO CODE	COMPACTO	COMPACTO D	REGRUESADO	MADERA
		COMPACT	COMPACT DEC	THICKNESS	WOOD
0794 Cromado Chrome	0794C	217.00	224.00	223.00	259.00
0794 Acero Inoxidable Stainless Steel	0794X	242.00	243.00	250.00	285.00

T 75 T 70x70 11,80 1 0,077 70

- Interiores/cubierto Indoor/cover
- Útil para exteriores Outdoor

**Madera (e:22mm) Wood - M**

MH MF MO MW

**Regruesado (e:40mm) Thicknesser (e:40mm) - G**

GB GN GZ GW

NOTA: El Regruesado se fabrican sólo en tapa cuadrada  
NOTE: Thicknesser is manufactured in Squared top only

**Compacto (e:10mm) Compact - C**

CB C6 CK CJ CT CU C3 CA CN

CG CW CO CE

**Compacto decorado (e:10mm) Compact - 2**

2N 2B 2X

# 0790 - 0793

Mesa con estructura de acero inoxidable o cromo con tubo de 76 mm. Tapa en los diferentes acabados.  
Table with stainless steel or chrome structure with pipe of 76 mm. Cover in different finishes.



ESTRUCTURA FRAMEWORK	CÓDIGO CODE	COMPACTO	COMPACTO D	REGRUESADO	MADERA
		COMPACT	COMPACT DEC	THICKNESS	WOOD
0790 Cromado Chrome	0790C	241.00	245.00	•	276.00
0790 Acero Inoxidable Stainless Steel	0790X	267.00	270.00	•	301.00

T 75 T 80 11,50 1 0,077 80

ESTRUCTURA FRAMEWORK	CÓDIGO CODE	COMPACTO	COMPACTO D	REGRUESADO	MADERA
		COMPACT	COMPACT DEC	THICKNESS	WOOD
0793 Cromado Chrome	0793C	241.00	245.00	334.00	277.00
0793 Acero Inoxidable Stainless Steel	0793X	267.00	293.00	259.00	301.00

T 75 T 80x80 13,96 1 0,077 80

- Interiores/cubierto Indoor/cover
- Útil para exteriores Outdoor

**Madera (e:22mm) Wood - M**

MH MF MO MW

**Regruesado (e:40mm) Thicknesser (e:40mm) - G**

GB GN GZ GW

NOTA: El Regruesado se fabrican sólo en tapa cuadrada  
NOTE: Thicknesser is manufactured in Squared top only

**Compacto (e:10mm) Compact - C**

CB C6 CK CJ CT CU C3 CA CN

CG CW CO CE

**Compacto decorado (e:10mm) Compact - 2**

2N 2B 2X

# 0698 - 0699

Mesa con estructura de acero inoxidable o cromo con tubo de 76 mm. Tapa en los diferentes acabados.  
Table with stainless steel or chrome structure with pipe of 76 mm. Cover in different finishes.



ESTRUCTURA FRAMEWORK	CÓDIGO CODE	COMPACTO	COMPACTO DECO
		COMPACT	COMPACT DECO
0698 Cromado Chrome	0698C	214.00	221.00
0698 Acero Inoxidable Stainless Steel	0698X	236.00	244.00

T 110 T 60 14,00 1 0,067 60

ESTRUCTURA FRAMEWORK	CÓDIGO CODE	CRISTAL TRANSP.	CRISTAL OPACO	CRISTAL COLORES
		TRANSP. CRYSTAL	OPAQUE CRYSTAL	COLOURS CRYSTAL
0699 Cromado Chrome	0699C	280.00	297.00	307.00
0699 Acero Inoxidable Stainless Steel	0699X	303.00	320.00	330.00

T 110 T 70 16,00 1 0,067 70

- Interiores/cubierto Indoor/cover
- Útil para exteriores Outdoor

**Cristal (e:10mm) Crystal (e:10mm) - Q**

QO QS QJ QU Q3 QN



# 1070 - 1071 - 1072

Mesa con estructura de acero inoxidable o cromo con tubo de 76 mm. Tapa en los diferentes acabados.  
Table with stainless steel or chrome structure with pipe of 76 mm. Cover in different finishes.



ESTRUCTURA FRAMEWORK	CÓDIGO CODE	CRISTAL TRANSP. TRANSP. CRYSTAL	CRISTAL OPACO OPAQUE CRYSTAL	CRISTAL COLORES COLOURS CRYSTAL
		1070	Cromado Chrome	274.00
	Acero Inoxidable Stainless Steel	299.00	317.00	328.00

T 75 T 60 14,85 1 0,203 60

ESTRUCTURA FRAMEWORK	CÓDIGO CODE	CRISTAL TRANSP. TRANSP. CRYSTAL	CRISTAL OPACO OPAQUE CRYSTAL	CRISTAL COLORES COLOURS CRYSTAL
		1071	Cromado Chrome	295.00
	Acero Inoxidable Stainless Steel	320.00	344.00	357.00

T 75 T 70 16 1 0,203 70

ESTRUCTURA FRAMEWORK	CÓDIGO CODE	CRISTAL TRANSP. TRANSP. CRYSTAL	CRISTAL OPACO OPAQUE CRYSTAL	CRISTAL COLORES COLOURS CRYSTAL
		1072	Cromado Chrome	323.00
	Acero Inoxidable Stainless Steel	380.00	301.00	423.00

T 75 T 80 17,5 1 0,203 80

Interiores Indoor

Cristal (e:10mm) Crystal (e:10mm) - Q

Q0 QS QJ QU Q3 QN

# 0701

Mesa con estructura de acero inoxidable o cromo con tubo de 76 mm. Tapa en los diferentes acabados.  
Table with stainless steel or chrome structure with pipe of 76 mm. Cover in different finishes.



ESTRUCTURA FRAMEWORK	CÓDIGO CODE	COMPACTO COMPACT	COMPACTO DECO COMPACT DECO
			Bicapa aluminizado Bi-coat aluminized
	Cromado Chrome	238.00	245.00
	Acero Inoxidable Stainless Steel	294.00	301.00

T 126 T 70-40 16,00 1 0,093 70 40

Útil para exteriores Outdoor

Compacto (e:10mm) Compact - C

CB C6 CK CJ CT CU C3 CA CN  
CG CW CO CE

Compacto decorado (e:10mm) Compact - 2

2N 2B 2X

# 9988

Mesa con estructura de acero pintado en los diferentes acabados de pintura, con tubo de 30x30 mm. Tapa de madera de pino.  
Table with steel structure painted in different finishes with pipe of 30x30 mm. Cover in pine wood.



ESTRUCTURA FRAMEWORK	CÓDIGO CODE	MADERA WOOD
Pintado en aluminio bicapa, o consultar colores Painted in aluminium bilayer or see colors.	9988L	161.00

T 113 T 60x60 12,12 1 0,211

60

Madera (e:20mm) Wood - M

MP

Interiores/cubierto Indoor / Cover





# 0630

Estructura de acero en pintura epoxi a elegir entre distintos colores (consultar apartado acabados).  
Steel structure in epoxy paint to available in different colours (see section finishes).



**Bicapa aluminizado(L)**  
Bi-coat aluminized(L)  
**Blanco (B)**  
White (1)  
**Negro (N)**  
Black (T)

ESTRUCTURA FRAMEWORK	CÓDIGO CODE	MELAMINA MELAMINE	COMPACTO COMPACT
Pintado en aluminio bicapa, o consultar colores <i>Painted in aluminium bilayer or see colors.</i>	0630L 0630B 0630N	65.00	106.00
Cromado <i>Chrome</i>	0630C	98.70	141.00

T 75 T 60 6,000 4 0,053 60

Interiores *Indoor*  
 Útil para exteriores *Outdoor*

**Compacto (e:10mm) Compact - C**  
CB C6 CK CJ CT CU C3 CA CN  
CG CW CO CE  
**Melamina (e:19mm) Melamine - F**  
F

# 0654 - 0640 - 0644

Estructura de acero en pintura epoxi a elegir entre distintos colores (consultar apartado acabados).  
Steel structure in epoxy paint to available in different colours (see section finishes).



**Bicapa aluminizado(L)**  
Bi-coat aluminized(L)  
**Blanco (B)**  
White (1)  
**Negro (N)**  
Black (T)

ESTRUCTURA FRAMEWORK	CÓDIGO CODE	MELAMINA MELAMINE	COMPACTO COMPACT
0654	Pintado en aluminio bicapa, o consultar colores <i>Painted in aluminium bilayer or see colors.</i>	0654L 0654B 0654N	85.00 130.00
	Cromado <i>Chrome</i>	0654C	123.00 168.00

T 75 T 70X70 11,40 1 0,070 70

ESTRUCTURA FRAMEWORK	CÓDIGO CODE	MELAMINA MELAMINE	COMPACTO COMPACT
0640	Pintado en aluminio bicapa, o consultar colores <i>Painted in aluminium bilayer or see colors.</i>	0640L 0640B 0640N	90.00 155.00
	Cromado <i>Chrome</i>	0640C	128.00 193.00

T 75 T 80 12,00 1 0,079 80

ESTRUCTURA FRAMEWORK	CÓDIGO CODE	MELAMINA MELAMINE	COMPACTO COMPACT
0644	Pintado en aluminio bicapa, o consultar colores <i>Painted in aluminium bilayer or see colors.</i>	0644L 0644B 0644N	88.00 155.00
	Cromado <i>Chrome</i>	0644C	128.00 193.00

T 75 T 80X80 13,56 1 0,079 80

**Compacto (e:10mm) Compact - C**  
CB C6 CK CJ CT CU C3 CA CN  
CG CW CO CE  
**Melamina (e:19mm) Melamine - F**  
F

# 0612 - 0614 - 0615

Estructura de acero en pintura epoxi a elegir entre distintos colores (consultar apartado acabados).  
Steel structure in epoxy paint to available in different colours (see section finishes).



**Bicapa aluminizado(L)**  
Bi-coat aluminized(L)  
**Blanco (B)**  
White (1)  
**Negro (N)**  
Black (T)

ESTRUCTURA FRAMEWORK	CÓDIGO CODE	COMPACTO COMPACT	
0612	Bicapa aluminizado, blanco o negro <i>Bi-coat aluminized, white or black</i>	0612L 0612B 0612N	148.00

T 75 T 100X60 13,70 1 0,124 100

ESTRUCTURA FRAMEWORK	CÓDIGO CODE	COMPACTO COMPACT	
0614	Bicapa aluminizado, blanco o negro <i>Bi-coat aluminized, white or black</i>	0614L 0614B 0614N	174.00

T 75 T 110X70 16,00 1 0,081 110

ESTRUCTURA FRAMEWORK	CÓDIGO CODE	COMPACTO COMPACT	
0615	Bicapa aluminizado, blanco o negro <i>Bi-coat aluminized, white or black</i>	0615L 0615B 0615N	196.00

T 75 T 120X80 18,30 1 0,081 120

**Compacto (e:10mm) Compact - C**  
CB C6 CK CJ CT CU C3 CA CN  
CG CW CO CE

# 0693

Estructura de acero en pintura epoxi a elegir entre distintos colores (consultar apartado acabados).  
Steel structure in epoxy paint to available in different colours (see section finishes).



ESTRUCTURA FRAMEWORK	CÓDIGO CODE	COMPACTO COMPACT	
0693	Pintado en aluminio bicapa, o consultar colores <i>Painted in aluminium bilayer or see colors.</i>	0693L 0693B 0693N	125.00
	Cromado <i>Chrome</i>	0693C	165.00

T 110 T 60 9,600 1 0,082 60

Interiores *Indoor*  
 Útil para exteriores *Outdoor*

**Compacto (e:10mm) Compact - C**  
CB C6 CK CJ CT CU C3 CA CN  
CG CW CO CE

# 1081 - 1081/1

Mesa plegable con estructura de aluminio en pintura epoxi a elegir entre distintos colores (consultar apartado colores). Tubo de 65 mm triangulado.  
Folding table with aluminium frame in epoxy paint to available in different colours. 65 mm tube.



ESTRUCTURA FRAMEWORK	CÓDIGO CODE	COMPACTO COMPACT
1081 Pintado en aluminio bicapa, o consultar colores <i>Painted in aluminium bilayer or see colors.</i>	1081L	183.00
1081 Pintado en aluminio bicapa, o consultar colores <i>Painted in aluminium bilayer or see colors.</i>	1081L	183.00
1081/1 Pintado en aluminio bicapa, o consultar colores <i>Painted in aluminium bilayer or see colors.</i>	1081/1L	191.00
1081/1 Pintado en aluminio bicapa, o consultar colores <i>Painted in aluminium bilayer or see colors.</i>	1081/1L	191.00

T 110 T 60	9,700	1	0,054
------------	-------	---	-------

Indoor	Interiores Indoor
Outdoor	Útil para exteriores Outdoor
Folding	Plegable Folding

Compacto (e:10mm) Compact - C

CB	C6	CK	CJ	CT	CU	C3	CA	CN
CG	CW	CO	CE					

# 1082 - 1082/2

Mesa plegable con estructura de aluminio pintado con diferentes acabados  
Folding table with painted in aluminium structure



ESTRUCTURA FRAMEWORK	CÓDIGO CODE	COMPACTO COMPACT
1082 Pintado en aluminio bicapa, o consultar colores <i>Painted in aluminium bilayer or see colors.</i>	1082L	175.00
1082 Pintado en aluminio bicapa, o consultar colores <i>Painted in aluminium bilayer or see colors.</i>	1082L	175.00
1082/1 Pintado en aluminio bicapa, o consultar colores <i>Painted in aluminium bilayer or see colors.</i>	1082/1L	184.00
1082/1 Pintado en aluminio bicapa, o consultar colores <i>Painted in aluminium bilayer or see colors.</i>	1082/1L	184.00

T 75 T 70X70	10,8	1	0,037
--------------	------	---	-------

Indoor	Interiores Indoor
Outdoor	Útil para exteriores Outdoor
Folding	Plegable Folding

Compacto (e:10mm) Compact - C

CB	C6	CK	CJ	CT	CU	C3	CA	CN
CG	CW	CO	CE					

# 0627 - 0620 - 0628 - 0623 - 0625 - 0629

Mesa plegable con estructura de acero pintado en los diferentes acabados de pintura, con tubo de 28 mm. Tapa en los diferentes acabados.  
Folding table with steel structure painted in different finishes with pipe of 28 mm. Cover in different finishes.



ESTRUCTURA FRAMEWORK	CÓDIGO CODE	MELAMINA MELAMINE	COMPACTO COMPACT
0627 Pintado en aluminio bicapa, o consultar colores <i>Painted in aluminium bilayer or see colors.</i>	0627L 0627B 0627N	64.00	108.00

ESTRUCTURA FRAMEWORK	CÓDIGO CODE	MELAMINA MELAMINE	COMPACTO COMPACT
0620 Pintado en aluminio bicapa, o consultar colores <i>Painted in aluminium bilayer or see colors.</i>	0620L 0620B 0620N	64.00	108.00

T 75 T 70	8,400	2	0,165
-----------	-------	---	-------



ESTRUCTURA FRAMEWORK	CÓDIGO CODE	MELAMINA MELAMINE	COMPACTO COMPACT
0628 Pintado en aluminio bicapa, o consultar colores <i>Painted in aluminium bilayer or see colors.</i>	0628L 0628B 0628N	69.00	134.00

ESTRUCTURA FRAMEWORK	CÓDIGO CODE	MELAMINA MELAMINE	COMPACTO COMPACT
0623 Pintado en aluminio bicapa, o consultar colores <i>Painted in aluminium bilayer or see colors.</i>	0623L 0623B 0623N	69.00	134.00

T 75 T 80	9,500	2	0,197
-----------	-------	---	-------



ESTRUCTURA FRAMEWORK	CÓDIGO CODE	MELAMINA MELAMINE	COMPACTO COMPACT
0625 Pintado en aluminio bicapa, o consultar colores <i>Painted in aluminium bilayer or see colors.</i>	0625L 0625B 0625N	69.00	134.00

T 75 T 100X60	12,00	2	0,225
---------------	-------	---	-------

ESTRUCTURA FRAMEWORK	CÓDIGO CODE	MELAMINA MELAMINE	COMPACTO COMPACT
0629 Pintado en aluminio bicapa, o consultar colores <i>Painted in aluminium bilayer or see colors.</i>	0629L 0629B 0629N	99.00	177.00

T 75 T 120X80	16,30	1	0,292
---------------	-------	---	-------

Indoor	Interiores Indoor
Outdoor	Útil para exteriores Outdoor
Folding	Plegable Folding

Compacto (e:10mm) Compact - C

CB	C6	CK	CJ	CT	CU	C3	CA	CN
CG	CW	CO	CE					

Melamina (e:19mm) Melamine - F

F
---

# 0715 - 0718 - 0710 - 0712

Mesa con estructura de acero pintado en los diferentes acabados de pintura, cromo o acero inoxidable, con tubo de 30 mm. Tapa en los diferentes acabados.  
 Table with steel structure painted in different finishes, chrome or stainless steel, with pipe of 30 mm. Cover in different finishes.



ESTRUCTURA FRAMEWORK	CÓDIGO CODE	ACERO INOX STAINLESS STEEL	COMPACTO COMPACT
		Pintado en aluminio bicapa, o consultar colores <i>Painted in aluminium bilayer or see colors.</i>	0715L
Cromado <i>Chrome</i>	0715C	138.00	161.00
Acero Inoxidable <i>Stainless Steel</i>	0715X	215.00	235.00

T 75 T 70 9,500 1 0,126 70



ESTRUCTURA FRAMEWORK	CÓDIGO CODE	ACERO INOX STAINLESS STEEL	COMPACTO COMPACT
		Pintado en aluminio bicapa, o consultar colores <i>Painted in aluminium bilayer or see colors.</i>	0718L
Cromado <i>Chrome</i>	0718C	138.00	161.00
Acero Inoxidable <i>Stainless Steel</i>	0718X	215.00	235.00

T 75 T 70X70 10,910 1 0,126 70



ESTRUCTURA FRAMEWORK	CÓDIGO CODE	ACERO INOX STAINLESS STEEL	COMPACTO COMPACT
		Pintado en aluminio bicapa, o consultar colores <i>Painted in aluminium bilayer or see colors.</i>	0710L
Cromado <i>Chrome</i>	0710C	153.00	183.00
Acero Inoxidable <i>Stainless Steel</i>	0710X	229.00	260.00

T 75 T 80 12,00 1 0,135 80



ESTRUCTURA FRAMEWORK	CÓDIGO CODE	ACERO INOX STAINLESS STEEL	COMPACTO COMPACT
		Pintado en aluminio bicapa, o consultar colores <i>Painted in aluminium bilayer or see colors.</i>	0712L
Cromado <i>Chrome</i>	0712C	153.00	183.00
Acero Inoxidable <i>Stainless Steel</i>	0712X	229.00	260.00

T 75 T 80X80 13,070 1 0,135 80

Interiores/cubierto *Indoor/cover*  
 Útil para exteriores *Outdoor*

Acero Inoxidable (e:21mm) *Stainless Steel - XX*



Compacto (e:10mm) *Compact - C*

CB	C6	CK	CJ	CT	CU	C3	CA	CN
CG	CW	CO	CE					

# 0740

Mesa con estructura de acero pintado en los diferentes acabados de pintura, cromo o acero inoxidable, con tubo de 30 mm. Tapa en los diferentes acabados.  
 Table with steel structure painted in different finishes, chrome or stainless steel, with pipe of 30 mm. Cover in different finishes.



ESTRUCTURA FRAMEWORK	CÓDIGO CODE	COMPACTO COMPACT
		Pintado en aluminio bicapa, o consultar colores <i>Painted in aluminium bilayer or see colors.</i>
Cromado <i>Chrome</i>	0740C	211.00
Acero Inoxidable <i>Stainless Steel</i>	0740X	336.00

T 75 T 110X70 17,00 1 0,081 110

Sólo en interiores *Indoor*  
 Útil para exteriores *Outdoor*

70  
110

Compacto (e:10mm) *Compact - C*

CB	C6	CK	CJ	CT	CU	C3	CA	CN
CG	CW	CO	CE					

# 0694

Mesa con estructura de acero pintado en los diferentes acabados de pintura, cromo o acero inoxidable, con tubo de 30 mm. Tapa en los diferentes acabados.  
 Table with steel structure painted in different finishes, chrome or stainless steel, with pipe of 30 mm. Cover in different finishes.



ESTRUCTURA FRAMEWORK	CÓDIGO CODE	COMPACTO COMPACT
		Pintado en aluminio bicapa, o consultar colores <i>Painted in aluminium bilayer or see colors.</i>
Cromado <i>Chrome</i>	0694C	145.00
Acero Inoxidable <i>Stainless Steel</i>	0694X	251.00

T 110 T 60 10,60 1 0,293 60

60

Compacto (e:10mm) *Compact - C*

CB	C6	CK	CJ	CT	CU	C3	CA	CN
CG	CW	CO	CE					



# 0605

Mesa con estructura de acero pintado en los diferentes acabados de pintura, cromo o acero inoxidable, con tubo de 30 mm. Tapa en los diferentes acabados.  
Table with steel structure painted in different finishes, chrome or stainless steel, with pipe of 30 mm. Cover in different finishes.



ESTRUCTURA FRAMEWORK	CÓDIGO CODE	COMPACTO COMPACT
Pintado en aluminio bicapa, o consultar colores <i>Painted in aluminium bilayer or see colors.</i>	0605L 0605N	147.00
Cromado <i>Chrome</i>	0605C	159.60

T 75	T 70	kg 10,10	4	0,600	70
------	------	----------	---	-------	----

Indoors/cubierto <i>Indoor/cover</i>
Útil para exteriores <i>Outdoor</i>

Compacto (e:10mm) Compact - C

CB	C6	CK	CJ	CT	CU	C3	CA	CN
CG	CW	CO	CE					

Compacto decorado (e:10mm) Compact - 2

2N	2B	2X
----	----	----

Bicapa aluminizado(L)  
*Bi-coat aluminized(L)*

Negro (N)  
*Black (T)*

# 0608

Mesa con estructura de acero pintado en los diferentes acabados de pintura, cromo o acero inoxidable, con tubo de 30 mm. Tapa en los diferentes acabados.  
Table with steel structure painted in different finishes, chrome or stainless steel, with pipe of 30 mm. Cover in different finishes.



ESTRUCTURA FRAMEWORK	CÓDIGO CODE	COMPACTO COMPACT
Pintado en aluminio bicapa, o consultar colores <i>Painted in aluminium bilayer or see colors.</i>	0608L 0608N	162.00
Cromado <i>Chrome</i>	0608C	178.00

T 75	T 80	kg 11,70	4	1,200	80
------	------	----------	---	-------	----

Indoors/cubierto <i>Indoor/cover</i>
Útil para exteriores <i>Outdoor</i>

Compacto (e:10mm) Compact - C

CB	C6	CK	CJ	CT	CU	C3	CA	CN
CG	CW	CO	CE					

Compacto decorado (e:10mm) Compact - 2

2N	2B	2X
----	----	----

Bicapa aluminizado(L)  
*Bi-coat aluminized(L)*

Negro (N)  
*Black (T)*

# 1000 - 1002 - 1004

Mesa con estructura de acero y base de aluminio pintado en los diferentes acabados de pintura. Tapa en los diferentes acabados.  
Table with steel structure and aluminium base painted in different finishes. Cover in different finishes.



ESTRUCTURA FRAMEWORK	CÓDIGO CODE	COMPACTO COMPACT
1000 Pintado en aluminio bicapa, o consultar colores <i>Painted in aluminium bilayer or see colors.</i>	1000N	189.00

T 75	T 70x70	kg 20,90	1	0,039	70
------	---------	----------	---	-------	----

ESTRUCTURA FRAMEWORK	CÓDIGO CODE	COMPACTO COMPACT
1002 Pintado en aluminio bicapa, o consultar colores <i>Painted in aluminium bilayer or see colors.</i>	1002N	202.00

T 75	T 80	kg 21,60	1	0,030	80
------	------	----------	---	-------	----

ESTRUCTURA FRAMEWORK	CÓDIGO CODE	COMPACTO COMPACT
1004 Pintado en aluminio bicapa, o consultar colores <i>Painted in aluminium bilayer or see colors.</i>	1004N	202.00

T 75	T 80x80	kg 23,20	1	0,039	80
------	---------	----------	---	-------	----

Indoors <i>Indoor</i>
Útil para exteriores <i>Outdoor</i>

Compacto (e:10mm) Compact - C

CB	C6	CK	CJ	CT	CU	C3	CA	CN
CG	CW	CO	CE					

# 1014 - 1012 - 1010

Mesa con estructura de acero y base de aluminio pintado en los diferentes acabados de pintura. Tapa en los diferentes acabados.  
Table with steel structure and aluminium base painted in different finishes. Cover in different finishes.



ESTRUCTURA FRAMEWORK	CÓDIGO CODE	COMPACTO COMPACT
1014 Pintado en aluminio bicapa, o consultar colores <i>Painted in aluminium bilayer or see colors.</i>	1014N	192.00

T 75	T 70x70	kg 23,30	1	0,030	70
------	---------	----------	---	-------	----

ESTRUCTURA FRAMEWORK	CÓDIGO CODE	COMPACTO COMPACT
1012 Pintado en aluminio bicapa, o consultar colores <i>Painted in aluminium bilayer or see colors.</i>	1012N	204.00

T 75	T 80	kg 23,70	1	0,039	80
------	------	----------	---	-------	----

ESTRUCTURA FRAMEWORK	CÓDIGO CODE	COMPACTO COMPACT
1010 Pintado en aluminio bicapa, o consultar colores <i>Painted in aluminium bilayer or see colors.</i>	1010N	204.00

T 75	T 80x80	kg 25,30	1	0,039	80
------	---------	----------	---	-------	----

Compacto (e:10mm) Compact - C

CB	C6	CK	CJ	CT	CU	C3	CA	CN
CG	CW	CO	CE					

Indoors <i>Indoor</i>
Útil para exteriores <i>Outdoor</i>



# 1040

Mesa con estructura de aluminio fundido, pintado en los diferentes acabados de pintura. Tapa en los diferentes acabados.  
Table with structure molten painted aluminium, different finishes. Cover in different finishes.



ESTRUCTURA FRAMEWORK	CÓDIGO CODE	COMPACTO COMPACT
Pintado en aluminio bicapa, o consultar colores <i>Painted in aluminium bilayer or see colors.</i>	1040N	186.00

T 75 T 70X70 12,60 1 0,058

Interiores *Indoor*  
Útil para exteriores *Outdoor*

**Compacto (e:10mm) Compact - C**

CB C6 CK CJ CT CU C3 CA CN  
CG CW CO CE

# 1050 - 1052 - 1054

Mesa con estructura de aluminio fundido, pintado en los diferentes acabados de pintura. Tapa en los diferentes acabados.  
Table with structure molten painted aluminium, different finishes. Cover in different finishes.



ESTRUCTURA FRAMEWORK	CÓDIGO CODE	COMPACTO COMPACT
1050 Pintado en aluminio bicapa, o consultar colores <i>Painted in aluminium bilayer or see colors.</i>	1050N	215.00
1052 Pintado en aluminio bicapa, o consultar colores <i>Painted in aluminium bilayer or see colors.</i>	1052N	238.00
1054 Pintado en aluminio bicapa, o consultar colores <i>Painted in aluminium bilayer or see colors.</i>	1054N	238.00

T 75 T 70X70 13,90 1 0,055

T 75 T 80 14,50 1 0,067

T 75 T 80X80 16,10 1 0,067

Interiores *Indoor*  
Útil para exteriores *Outdoor*

**Compacto (e:10mm) Compact - C**

CB C6 CK CJ CT CU C3 CA CN  
CG CW CO CE

# 0702

Mesa con estructura de acero pintado en los diferentes acabados de pintura o cromo, con tubo de 20 mm. Tapa en los diferentes acabados.  
Table with steel structure painted in different finishes or chrome with pipe of 20 mm. Cover in different finishes.



ESTRUCTURA FRAMEWORK	CÓDIGO CODE	COMPACTO COMPACT	COMPACTO DECO DECORATED COMPACT
Pintado en aluminio bicapa, o consultar colores <i>Painted in aluminium bilayer or see colors.</i>	0702L 07021 0702T	112.00	119.00
Cromado <i>Chrome</i>	0702C	127.00	134.00

T 110 T 60 8,500 1 0,239

Interiores *Indoor*  
Útil para exteriores *Outdoor*

**Compacto (e:10mm) Compact - C**

CB C6 CK CJ CT CU C3 CA CN  
CG CW CO CE

**Compacto decorado (e:10mm) Compact - 2**

2N 2B 2X

- Bicapa aluminizado(L)  
*Bi-coat aluminized(L)*
- Blanco Mate (1)  
*Mate White (1)*
- Negro Texturizado (T)  
*Textured Black (T)*

# 0700

Mesa con estructura de aluminio y base de acero inoxidable. Tapa en los diferentes acabados.  
Table with aluminium structure and stainless steel base. Cover in different finishes.



ESTRUCTURA FRAMEWORK	CÓDIGO CODE	ACERO INOX STAINLESS STEEL	COMPACTO COMPACT	COMPACTO DECO DECORATED COMPACT
Tubo de Aluminio y base en acero inoxidable <i>Aluminium tube and Stainless Steel base.</i>	0700X	265.00	276.00	282.00

T 110 T 60 8,300 1 0,070

Interiores *Indoor*  
Útil para exteriores *Outdoor*

**Compacto (e:10mm) Compact - C**

CB C6 CK CJ CT CU C3 CA CN  
CG CW CO CE

**Acero Inoxidable (e:21mm) Stainless Steel - XX**

**Compacto decorado (e:10mm) Compact - 2**

2N 2B 2X

# 0801 - 0802 - 0803 - 0804

Mesa con estructura de acero inoxidable o cromo con tubo de 76 mm. Tapa en los diferentes acabados.  
Table with stainless steel structure or chromed with tube of 76 mm. Top cover with the same finished.



	ESTRUCTURA FRAMEWORK	CÓDIGO CODE	COMPACTO COMPACT	CRISTAL TR. TRASP. CRYSTAL	CRISTAL OP. OPAQ. CRYSTAL	CRISTAL COL. COL. CRYSTAL	
0801	Cromado Chrome	0801C	198.00	256.00	274.00	285.00	60
	Acero Inoxidable Stainless Steel	0801X	226.00	283.00	301.00	312.00	60
0802	Cromado Chrome	0802C	198.00	•	•	•	60
	Acero Inoxidable Stainless Steel	0802X	226.00	•	•	•	60

T 42 T 60x60 kg 7,700 1 0,052

	ESTRUCTURA FRAMEWORK	CÓDIGO CODE	COMPACTO COMPACT	CRISTAL TR. TRASP. CRYSTAL	CRISTAL OP. OPAQ. CRYSTAL	CRISTAL COL. COL. CRYSTAL	
0803	Cromado Chrome	0803C	211.00	277.00	300.00	314.00	70
	Acero Inoxidable Stainless Steel	0803X	338.00	304.00	327.00	341.00	70
0804	Cromado Chrome	0804C	211.00	•	•	•	70
	Acero Inoxidable Stainless Steel	0804X	238.00	•	•	•	70

T 42 T 70x70 kg 9,200 1 0,077

Cristal (e:10mm) Crystal (e:10mm) - Q  
Q0 QS QJ QU Q3 QN

Compacto (e:10mm) Compact - C  
CB C6 CK CJ CT CU C3 CA CN CG CW CO CE

Sólo en interiores Indoor  
Útil para exteriores Outdoor

# 1001 - 1011

Mesa con estructura de acero pintado en los diferentes acabados de pintura con tubo de 80x80 mm. Tapa en los diferentes acabados.  
Table with steel structure painted in the different ones finished, with tube of 80x80 mm. Top cover with the same finished.



	ESTRUCTURA FRAMEWORK	CÓDIGO CODE	COMPACTO COMPACT	COMPACTO D. COMPACT DEC.	REGRUESADO THICKNESS	MADERA WOOD	
1001	Pintado en aluminio bicapa, o consultar colores. Painted in aluminium bilayer or see colors.	1001L	262.00	295.00	271.00	305.00	70
	Acero Inoxidable Stainless Steel	1001X	311.00	344.00	314.00	353.00	110
1011	Bicapa aluminizado Bi-coat aluminized	1011L	274.00	302.00	288.00	344.00	80
	Acero Inoxidable Stainless Steel	1011X	323.00	352.00	337.00	394.00	120

T 42 T 120x70 kg 28,00 1 0,098

Interiores/cubierto Indoor/cover  
Sólo en interiores Indoor  
Útil para exteriores Outdoor

Regruesado (e:40mm) Thicknesser (e:40mm) - G  
GB GN GZ GW

Compacto (e:10mm) Compact - C  
CB C6 CK CJ CT CU C3 CA CN CG CW CO CE

Compacto decorado (e:10mm) Compact - 2  
2N 2B 2X  
Madera (e:22mm) Wood - M  
MH MF MO MW

# 9995

Mesa cubitera con estructura de acero termolacado, soporte de cubitera en compacto fenólico y una cubitera de policarbonato translúcido de 33 cm Ø.  
Ice bucket table with thermo-lacquered steel structure, ice bucket holder in a phenolic compact and a translucent polycarbonate ice bucket of 33 cm Ø.



ESTRUCTURA FRAMEWORK	CÓDIGO CODE	COMPACTO COMPACT
Pintado en aluminio bicapa, o consultar colores. Painted in aluminium bilayer or see colors.	9995L	162.00

T 110 T 60 kg 12,44 1 0,239 60

Útil para exteriores Outdoor

Compacto Compact - C  
CB C6 CK CJ CT CU C3 CA CN CG CW CO CE





0616

Mesa plegable con estructura de acero termolacado. Tapa de compacto fenólico a elegir entre los diferentes acabados.  
Folding table with steel structure painted in different finishes. Cover in different finishes.



ESTRUCTURA FRAMEWORK	CÓDIGO CODE	COMPACTO COMPACT
Pintado en aluminio bicapa, o consultar colores <i>Painted in aluminium bilayer or see colors.</i>	0616L	76.00

T 110 T 60    7,40    1    0,054    60

Útil para exteriores *Outdoor*

Compacto *Compact - C*

CB C6 CK CJ CT CU C3 CA CN CG CW CO CE

0671

Mesa con estructura de aluminio. Tapa en los diferentes acabados.  
Table with aluminium structure. Cover in different finishes.



ESTRUCTURA FRAMEWORK	CÓDIGO CODE	COMPACTO COMPACT
Aluminio <i>Aluminium.</i>	0671	139.00

T 110 T 60    9,500    1    0,054    60

Interiores *Indoor*

Compacto *Compact - C*

CB C6 CK CJ CT CU C3 CA CN CG CW CO CE

0721

Mesa plegable con estructura de acero pintado en los diferentes acabados de pintura. Tapa en los diferentes acabados.  
Folding table with steel structure painted in different finishes. Cover in different finishes.



ESTRUCTURA FRAMEWORK	CÓDIGO CODE	COMPACTO COMPACT
Pintado en aluminio bicapa, o consultar colores <i>Painted in aluminium bilayer or see colors.</i>	0721L	95.00

T 110 T 60    9,680    1    0,054    60

Útil para exteriores *Outdoor*

Compacto *Compact - C*

CB C6 CK CJ CT CU C3 CA CN CG CW CO CE

# COMPLEMENTOS DE EXTERIOR

EXTERIOR COMPLEMENTS

Separadores | Sombrillas | Vallas | Estufas

Terrace dividers | Umbrellas | Fences | Stoves

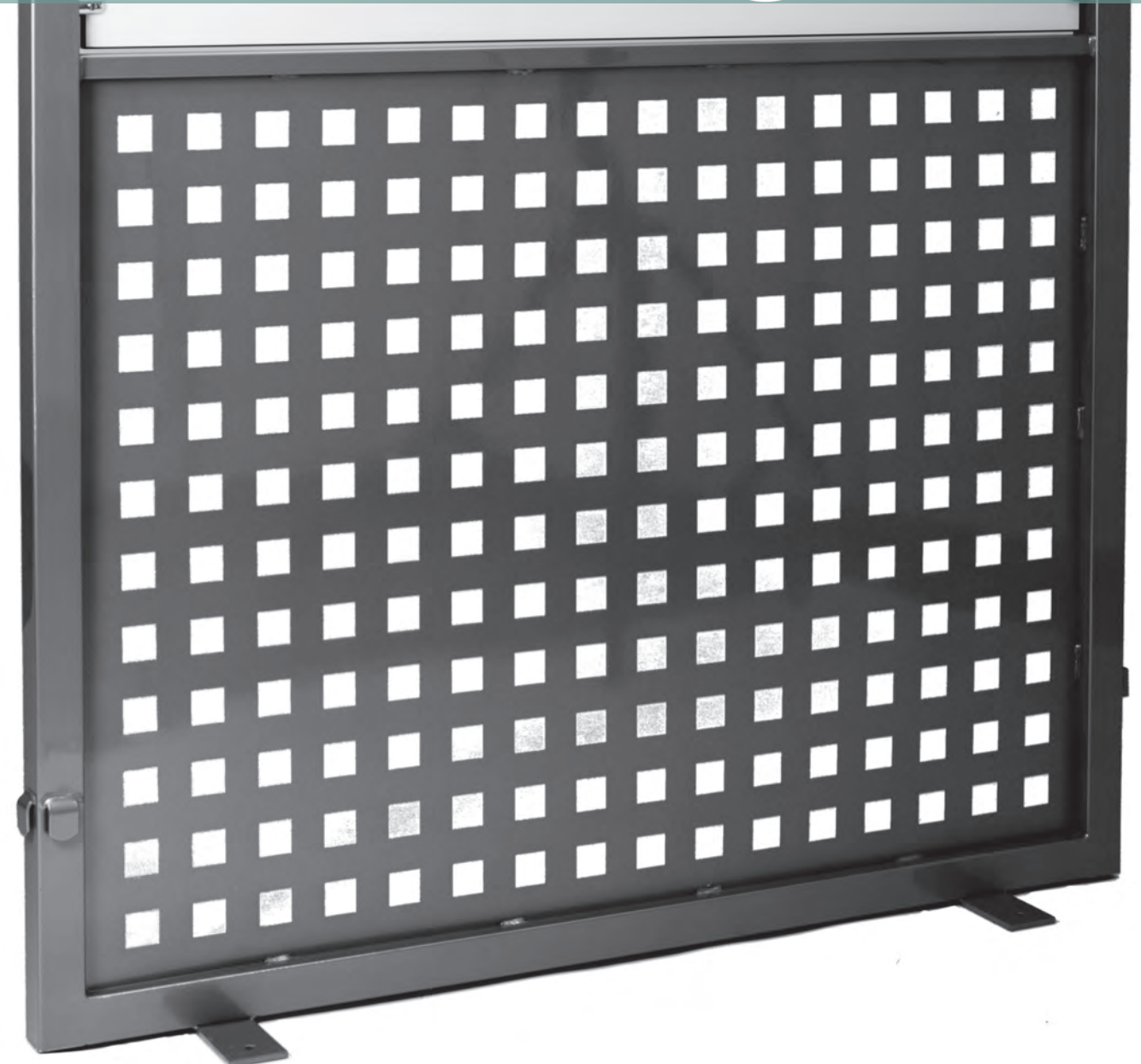
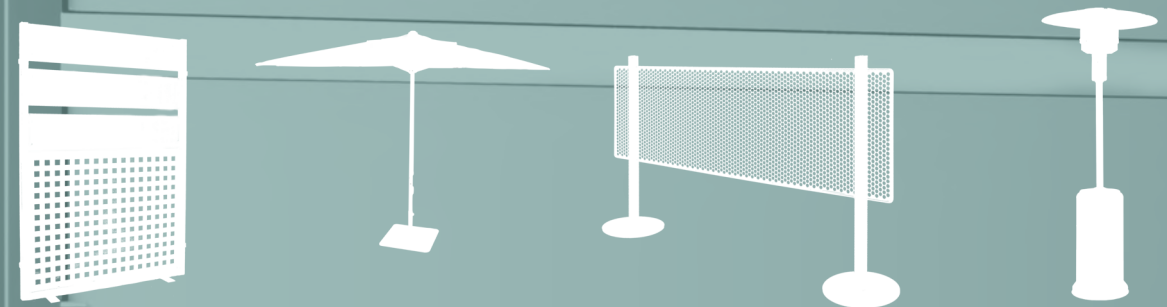

## MESAS PIE CENTRAL

### PEDESTAL BASE TABLES |

#### TABLES PIED CENTRAL

Toledo aire cuadrada	128
Toledo aire redonda	129
Fall	132
Drop	133
Barcino pie central	134
Barcino pie central red.	135
Sputnik pie central simple	136
Sputnik pie central doble	137
Net	140
Vela S	142
Vela M	144
Vela L	145

## MESAS 4 PATAS

### 4 LEG TABLES | TABLES 4 PIEDS

Barcino	146
Barcino compact	147
Corner	148
Point	152
Noa	154
New Dessa	156
New Flash	157

## MESAS PIE CENTRAL ALTO

### HIGH PEDESTAL BASE TABLE |

#### TABLE PIED CENTRAL HAUTE

Barcino pie central alto	158
Sputnik pie central alto	159



# TOLEDO AIRE

JORGE PENSI

Mesa  
Table  
Table

- Marfil | Ivory | Ivoire
- Gris Verdoso | Green-grey | Gris Vert
- Chocolate | Chocolate | Chocolat

Pie disponible en:  
Pedestal available in:  
Pied disponible en:

- Blanco | White | Blanc
- Negro | Black | Noir



Mesa para uso interior y exterior. Estructura de aluminio pintado y sobre en compacto fenólico del mismo color. Disponible en dos medidas 70 x 70 cm y 80 x 80 cm.

Table for indoor and outdoor use. Painted aluminium structure with an HPL table top of the same colour. Available in two different sizes 70 x 70 cm (27.55 x 27.55 in) and 80 x 80 cm (31.49 x 31.49 in).

Table pour usage intérieur et extérieur. Structure en aluminium peint et plateau en compact phénolique du même coloris. Disponible en dimensions 70x70 et 80x80cm.

<b>SIZE 70x70</b>	<b>SIZE 27.55x27.55 in</b>
W 70 cm	W 27.55 in
L 70 cm	L 27.55 in
H 74 cm	H 29.13 in

<b>SIZE 80x80</b>	<b>SIZE 31.49x31.49 in</b>
W 80 cm	W 31.49 in
L 80 cm	L 31.49 in
H 74 cm	H 29.13 in

W: ancho / width / largeur. L: largo / length / longueur  
H: altura / height / hauteur. Hs: altura asiento / seat height / hauteur du siège. Ha: altura brazo / arm height / hauteur du bras  
Ø: diámetro / diameter / diamètre.

STD units	Packaging dim. (cm)	M3/ pack	NW units (kg)	Units Container 20'	Units Container 40'	Units Container HC	Units Truck 70m³	Units Truck 100m³
1	71x74x20	0,105	9,75	154	350	350	462	504
1	81x84x20	0,136	11,47	165	375	375	495	540

# TOLEDO AIRE

JORGE PENSI

Mesa  
Table  
Table

- Marfil | Ivory | Ivoire
- Gris Verdoso | Green-grey | Gris Vert
- Chocolate | Chocolate | Chocolat

Pie disponible en:  
Pedestal available in:  
Pied disponible en:

- Blanco | White | Blanc
- Negro | Black | Noir



Mesa para uso interior y exterior. Estructura de aluminio pintado y sobre en compacto fenólico del mismo color. Disponible en dos medidas Ø70 cm y Ø80 cm..

Table for indoor and outdoor use. Painted aluminium structure with an HPL table top of the same colour. Available in two different sizes Ø70 cm (Ø27.55 in) and Ø80 cm (Ø31.49 in).

Table pour usage intérieur et extérieur. Structure en aluminium peint et plateau en compact phénolique du même coloris. Disponible en dimensions Ø70cm et Ø80cm.

SIZE ø70 cm | SIZE ø27.55 in  
H 74,0 cm | H 29.13 in

SIZE ø80 cm | SIZE ø31.49 in  
H 74,0 cm | H 29.13 in

W: ancho / width / largeur. L: largo / length / longueur  
H: altura / height / hauteur. Hs: altura asiento / seat height / hauteur du siège. Ha: altura brazo / arm height / hauteur du bras  
Ø: diámetro / diameter / diamètre.

STD units	Packaging dim. (cm)	M3/ pack	NW units (kg)	Units Container 20'	Units Container 40'	Units Container HC	Units Truck 70m³	Units Truck 100m³
1	71x74x20	0,105	8,25	154	350	350	462	504
1	81x84x20	0,136	9,67	165	375	375	495	540





Silla Toledo Aire (p. 26), mesa Toledo Aire (p. 129)  
Toledo Aire chair (p. 26), Toledo Aire table (p. 129)  
Chaise Toledo Aire (p. 26), table Toledo Aire (p. 129)





# FALL

Pie  
Pedestal  
Pied

 Apilable  
Stackable | Empilable

- Blanco | White | Blanc
- Negro | Black | Noir
- Arena | Sand | Sable



Pie de mesa en aluminio pintado. Sistema abatible. Uso interior y exterior. (Consultar tabla de combinaciones de pies y sobres en pag. 162)

Table base in painted aluminium. Folding system. Indoor and outdoor use. (See table combination for pedestalar bases and table tops on pag. 162)

Pied de table en aluminium peint. Système de repliment. Utilisation intérieur et extérieur. (Voir le tableau de combinaison pour piedset plateaux pag. 162)



W 50 cm | W 35.43 in  
L 50 cm | L 35.43 in  
H 79 cm | H 28.34 in

**W:** ancho / width / largeur. **L:** largo / length / longueur  
**H:** altura / height / hauteur. **Hs:** altura asiento / seat height / hauteur du siège. **Ha:** altura brazo / arm height / hauteur du bras  
**Ø:** diámetro / diameter / diamètre.

STD units	Packaging dim. (cm)	M3/ pack	NW units (kg)	Units Container 20'	Units Container 40'	Units Container HC	Units Truck 70m³	Units Truck 100m³
1	59x55x13,5	0,043	8,25	630	1.300	1.500	1.700	1.900
	+64,5x7x7	+0,003						

# DROP

## BARCELONA Dd

Pie  
Pedestal  
Pied

 Apilable  
Stackable | Empilable

- Blanco | White | Blanc
- Arena | sand | sable
- Negro | Black | Noir

Disponible hasta final de existencias.  
Available until end of stock  
Disponible jusqu'à la fin du stock



Pie de mesa en aluminio pintado. Sistema abatible. Uso interior y exterior. (Consultar tabla de combinaciones de pies y sobres en pag. 162).

Table base in painted aluminium. Folding system. Indoor and outdoor use. (See table combination for pedestral bases and table tops on pag. 162).

Pied de table en aluminium peint. Système de repilement. Utilisation intérieur et extérieur. (Voir le tableau de combinaison pour piedset plateaux pag. 162).

W 50 cm | W 35.43 in  
L 50 cm | L 35.43 in  
H 72 cm | H 29.13 in

W: ancho / width / largeur. L: largo / length / longueur  
H: altura / height / hauteur. Hs: altura asiento / seat height / hauteur du siège. Ha: altura brazo / arm height / hauteur du bras  
Ø: diámetro / diameter / diamètre.

STD units	Packaging dim. (cm)	M3/ pack	NW units (kg)	Units Container 20'	Units Container 40'	Units Container HC	Units Truck 70m <sup>3</sup>	Units Truck 100m <sup>3</sup>
1	59x55x13,5	1,28	8,25	630	1.300	1.500	1.700	1.900
	+64,5x7x7	+0,17						

# BARCINO

JOAN GASPAR

Mesa pie central  
Pedestal base table  
Table pied central

Personalización de colores disponible bajo pedido y sujetos a cantidades mínimas. Consulte el Departamento Comercial.

Colour customization is available upon request. Minimum orders are applicable. Contact the Sales Department.

Personnalisation de couleurs disponible sur commande. Quantités minimales à appliquer. Consultez le Département Commerciale.



- Arena | sand | sable
- Negro | Black | Noir
- Blanco | White | Blanc

## 📄 Certificados | Certificates | Certificats

Barcino table Test Certificates:  
EN 581 PUBLIC



Mesa para uso interior y exterior. Estructura de aluminio anodizado pintado por pulverización y secado al horno 40 x 20 mm y 1,5 mm de grosor. Sobre de 4 mm de grosor. Barcino 80 x 80, base de 40 x 40 cm y tubo de 8 x 8 cm. Peso neto mesa 80 x 80, 26 kg. Barcino 90 x 90, base de 45 x 45 cm y tubo de 8 x 8 cm. Peso neto mesa 90 x 90, 33 kg.

Table for indoor and outdoor use. Powder coated anodized aluminium frame and oven-drying 40 x 20 mm and 1,5 mm thick. Table top of 4 mm thickness. Barcino 80 x 80, base of 40x 40 cm and tube of 8 x 8 cm. 80 x 80 table net weight 26 kg (57,32 lb). Barcino 90 x 90, base of 45 x 45 cm and tube of 8 x 8 cm. 90 x 90 table net weight 33 kg (72,75 lb).

Table pour usage intérieur et extérieur. Structure en aluminium anodisé peinte par pulvérisation et séchée au four 40 x 20 mm et 1,5 mm de grosseur. Plateau de 4 mm de grosseur. Barcino 80 x 80, base de 40 x 40 cm et tube de 8 x 8 cm. Poids net table 80 x 80, 26 kg. Barcino 90 x 90, base de 45 x 45 cm et tube de 8 x 8 cm. Poids net table 90 x 90, 33 kg.

W 80 cm	W 31.5 in
L 80 cm	L 31.5 in
H 74 cm	H 29.13 in

W 90 cm	W 35.43 in
L 90 cm	L 35.43 in
H 74 cm	H 29.13 in

W: ancho / width / largeur. L: largo / length / longueur  
H: altura / height / hauteur. Hs: altura asiento / seat height / hauteur du siège. Ha: altura brazo / arm height / hauteur du bras  
Ø: diámetro / diameter / diamètre.

STD units	Packaging dim. (cm)	M3/ pack	NW units (kg)	Units Container 20'	Units Container 40'	Units Container HC	Units Truck 70m <sup>3</sup>	Units Truck 100m <sup>3</sup>
1	82x82x15	0,10	26	200	440	440	-	-
1	92x92x15	0,13	33	200	440	440	-	-

# BARCINO

JOAN GASPAR

Mesa pie central  
Pedestal base table  
Table pied central

Personalización de colores disponible bajo pedido y sujetos a cantidades mínimas. Consulte el Departamento Comercial.

Colour customization is available upon request. Minimum orders are applicable. Contact the Sales Department.

Personnalisation de couleurs disponible sur commande. Quantités minimales à appliquer. Consultez le Département Commerciale.



- Arena | sand | sable
- Negro | Black | Noir
- Blanco | White | Blanc

## 📄 Certificados | Certificates | Certificats

Barcino table Test Certificates:  
EN 581 PUBLIC



Mesa para uso interior y exterior. Estructura de aluminio anodizado pintado por pulverización y secado al horno. Sobre de 4 mm de grosor. Barcino Ø 60 cm con base de Ø 35 cm y tubo de Ø 6 cm. Peso neto mesa Ø 60, 13 kg. Barcino Ø 80 cm con base de Ø 45 cm y tubo de Ø 8 cm. Peso neto mesa Ø 80, 22 kg.

Table for indoor and outdoor use. Powder coated anodized aluminium frame and oven-drying. Table top of 4 mm thickness. Barcino Ø 60 cm with base of Ø 35 cm and tube of Ø 6 cm. Ø 60 table net weight 13 kg (28,66 lb). Barcino Ø 80 cm with base of Ø 45 cm and tube of Ø 8 cm. Ø 80 table net weight 22 kg (48,50 lb).

Table pour usage intérieur et extérieur. Structure en aluminium anodisé peinte par pulvérisation et séchée au four. Plateau de 4 mm de gresseur. Barcino Ø 60 cm avec base de Ø 35 cm et tube de Ø 6 cm. Poids net table Ø 60, 13 kg. Barcino Ø 80 cm avec base de Ø 45 cm et tube de Ø 8 cm. Poids net table Ø 80, 22 kg.

Ø 60 cm | Ø 23.62 in  
H 74 cm | H 29.13 in

Ø 80 cm | Ø 31.49 in  
H 74 cm | H 29.13 in

W: ancho / width / largeur. L: largo / length / longueur  
H: altura / height / hauteur. Hs: altura asiento / seat height / hauteur du siège. Ha: altura brazo / arm height / hauteur du bras  
Ø: diámetro / diameter / diamètre.

STD units	Packaging dim. (cm)	M3/ pack	NW units (kg)	Units Container 20'	Units Container 40'	Units Container HC	Units Truck 70m³	Units Truck 100m³
1	62x62x13	0,05	13	220	500	500	600	-
1	82x82x15	0,10	22	220	440	440	-	-



# SPUTNIK

JOSEP LLUSCÀ

Pie  
Pedestal base  
Pied

- Blanco | White | Blanc
- Rojo | Red | Rouge
- Negro | Black | Noir

Acabados tubos | Tubes finishes |  
Finition du tube

- Aluminio brillante | Shiny Aluminium |  
Aluminium brillant
- Aluminio mate | Matt Aluminium |  
Aluminium mat
- Aluminio pintado blanco |  
White painted Aluminium |  
Aluminium peint en blanc
- Aluminio pintado negro |  
Black painted Aluminium |  
Aluminium peint en noir



Pie central simple para uso interior y exterior. El pie se compone de dos partes, una carcasa inyectada en poliamida y un contrapeso de hierro pintado. Tubo de aluminio anodizado de  $\varnothing 60 \times 2$  mm. de grosor en acabado brillante, mate o pintado blanco o negro. Protección contra rayos UV. Nivelador en una pata. Consultar tabla de combinaciones de pie y sobres en pág. 162.

Single pedestal base for indoor and outdoor use. The base is composed of two pieces, a casing injected with polyamide and a painted iron counterweight. Anodized aluminium tube,  $\varnothing 60 \times 2$  mm thick, shiny, matt or white or black painted finish. UV protection. Leveller in one leg. See table combination for pedestal bases and table tops on p. 162.

Pied central simple d'intérieur et extérieur. Pied central fait en deux parties, une carcasse injectée en polyamide et un contrepoids en fer, peint. Tube en aluminium anodisé brillant ou mat, ou tube en aluminium peint blanc ou noir de  $\varnothing 60 \times 2$  mm de grosseur. Protection contre les rayons UV. Niveleur sur un pied. Voir table de combinaisons entre pied central et plateau à la page 162.

W 52 cm | W 20.47 in  
L 52 cm | L 20.47 in  
H 68,5 cm | H 26.97 in

W: ancho / width / largeur. L: largo / length / longueur  
H: altura / height / hauteur. Hs: altura asiento / seat height /  
hauteur du siège. Ha: altura brazo / arm height / hauteur du bras  
Ø: diámetro / diameter / diamètre.

STD units	Packaging dim. (cm)	M3/ pack	NW units (kg)	Units Container 20'	Units Container 40'	Units Container HC	Units Truck 70m <sup>2</sup>	Units Truck 100m <sup>2</sup>
1	55x53x17	0,05	4,415	565	1.171	1.320	1.414	2.020

# SPUTNIK

JOSEP LLUSCÀ

Pie doble  
Double pedestal base  
Double pied

○ Blanco | White | Blanc

● Rojo | Red | Rouge

● Negro | Black | Noir

Acabados tubos | Tubes finishes |  
Finition du tube

● Aluminio brillante | Shiny Aluminium |  
Aluminium brillant

● Aluminio mate | Matt Aluminium |  
Aluminium mat

○ Aluminio pintado blanco |  
White painted Aluminium |  
Aluminium peint en blanc

● Aluminio pintado negro |  
Black painted Aluminium |  
Aluminium peint en noir



Pie central doble para uso interior y exterior. El pie se compone de dos partes, una carcasa inyectada en poliamida y un contrapeso de hierro pintado. Tubo de aluminio anodizado de  $\varnothing 60 \times 2$  mm. de grosor en acabado brillante, mate o pintado blanco o negro. Protección contra rayos UV. Nivelador en una pata. Consultar tabla de combinaciones de pie y sobres en pág. 162.

Double pedestal base for indoor and outdoor use. The base is composed of two pieces, a casing injected with polyamide and a painted iron counterweight. Anodized aluminium tube,  $\varnothing 60 \times 2$  mm thick, shiny, matt or white or black painted finish. UV protection. Leveller in one leg. See table combination for pedestal bases and table tops on p. 162.

Pied central double d'intérieur et extérieur. Pied central fait en deux parties, une carcasse injectée en polyamide et un contrepoids en fer, peint. Tube en aluminium anodisé brillant ou mat, ou tube en aluminium peint blanc ou noir de  $\varnothing 60 \times 2$  mm de grosseur. Protection contre les rayons UV. Niveleur sur un pied. Voir table de combinaisons entre pied central et plateau à la page 162.

W 52 cm | W 20.47 in  
L 52 cm | L 20.47 in  
H 68,5 cm | H 26.97 in

W: ancho / width / largeur. L: largo / length / longueur  
H: altura / height / hauteur. Hs: altura asiento / seat height /  
hauteur du siège. Ha: altura brazo / arm height / hauteur du bras  
Ø: diámetro / diameter / diamètre.

STD units	Packaging dim. (cm)	M3/ pack	NW units (kg)	Units Container 20'	Units Container 40'	Units Container HC	Units Truck 70m <sup>3</sup>	Units Truck 100m <sup>3</sup>
1	72x102x15	0,11	7,84	248	514	583	621	887

Sillas con brazos Fiona (p. 64), mesa Sputnik con tablero Werzalit (p. 136)

Fiona armchairs (p. 64), Sputnik table with Werzalit top (p. 136)

Fauteuils Fiona (p. 64), table Sputnik avec Werzalit plateau (p. 136)









# NET

LLUÍS CODINA

Pie  
Pedestal base  
Pied

○ Blanco | White | Blanc

● Negro | Black | Noir



Pie central para uso interior y exterior. Pie en inyección de aluminio pintado blanco y negro. Protección contra rayos UV. Consultar tabla de combinaciones de pie y sobres en pág. 162.

Pedestal base for indoor and outdoor use. Cast aluminium pedestal base, white and black painted. UV protection. See table combination for pedestal bases and table tops on p. 162.

Pied central d'intérieur et extérieur. Pied central injecté en aluminium peint en blanc et noir. Voir le tableau de combinaison pour pied central et plateau pag. 162.

Base 50,30 x 51 x 44 x 46 cm  
H 69,20 cm

Base 19.80 x 20.08x 17.32 x 18.11 in  
H 27.24 in

W: ancho / width / largeur. L: largo / length / longueur  
H: altura / height / hauteur. Hs: altura asiento / seat height /  
hauteur du siège. Ha: altura brazo / arm height / hauteur du bras  
Ø: diámetro / diameter / diamètre.

STD units	Packaging dim. (cm)	M3/ pack	NW units (kg)	Units Container 20'	Units Container 40'	Units Container HC	Units Truck 70m <sup>3</sup>	Units Truck 100m <sup>3</sup>
1	55x53x17	0,05	16,2	565	1.171	1.320	1.414	2.020

Sillas con brazos Fiona (p. 61 ), pie Net con sobre de HPL blanco (p. 140)

Fiona armchairs (p. 61), Net base with white HPL top (p. 140)

Fauteuils Fiona (p. 61), pied Net avec blanc HPL plateau (p. 140)



# VELA S

FABRIZIO BATONI

Pie  
Pedestal base  
Pied

- Blanco | White | Blanc
- Negro | Black | Noir
- Rojo | Red | Rouge
- Arena | sand | sable

 Certificados | Certificates | Certificats

Vela pedestal base Test Certificates:  
EN 15372 L3



Pie central para uso interior y exterior compuesto por dos bases inyectadas en fibra de vidrio con PP mediante tecnología de moldeo asistida por gas, unidas por una barra de aluminio. Protección UV. Peso neto 4 kg. Pie compatible con sobres de compacto fenólico y cristal templado de 70 x 70, 80 x 80, 90 x 90, Ø70, Ø80 y Ø90. Ver tabla de combinaciones en página 162.

Pedestal base for indoor and outdoor use, composed by two bases injected in fiberglass with PP using gas assisted injection moulding technology, joined by an aluminium bar. UV Protection. Net weight 4 kg (8.82 lb). Compatible base with HPL and tempered glass table tops of 70 x 70, 80 x 80, 90 x 90, Ø70, Ø80 and Ø90 cm. See table combinations on page 162.

Pied central pour usage intérieur et extérieur, composé par deux bases injectées en fibre de verre avec PP, en utilisant technologie de moulage assistée par gaz, unies par une barre en aluminium. Protection UV. Poids net 4 kg. Pied compatible avec plateaux de résine phénolique et verre trempé de 70 x 70, 80 x 80, 90 x 90, Ø70, Ø80 y Ø90. Voir table de combinaisons à la page 162.

W 61,5 cm | W 24.21 in  
L 60 cm | L 23.62 in  
H 72,5 cm | H 28.54 in

W: ancho / width / largeur. L: largo / length / longueur  
H: altura / height / hauteur. Hs: altura asiento / seat height / hauteur du siège. Ha: altura brazo / arm height / hauteur du bras  
Ø: diámetro / diameter / diamètre.

STD units	Packaging dim. (cm)	M3/pack	NW units (kg)	Units Container 20'	Units Container 40'	Units Container HC	Units Truck 70m³	Units Truck 100m³
1	83x74x27	0,17	4	-	312	-	360	-





Sillas Carla (p. 80), mesa Vela S con HPL blanco (p. 142)

Carla chairs (p. 80), table Vela S with white HPL (p. 142)

Carla chaises (p. 80), table Vela S avec HPL blanc (p. 142)



# VELA M

FABRIZIO BATONI

Pie  
Pedestal base  
Pied

- Blanco | White | Blanc
- Negro | Black | Noir
- Rojo | Red | Rouge
- Arena | sand | sable

 Certificados | Certificates | Certificats

Vela pedestal base Test Certificates:  
EN 15372 L3

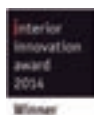

Pie central doble para uso interior y exterior compuesto por dos bases inyectadas en fibra de vidrio con PP mediante tecnología de moldeo asistida por gas, enlazadas entre sí por una barra de aluminio cubierto por un perfil de pvc texturizado. Protección UV. Peso neto 4,65 kg. Base compatible con sobres de compacto fenólico de 120 x 80 y cristal templado de 120 x 80 y de 150 x 110 ovalado. Ver tabla de combinaciones en página 162.

Double pedestal base for indoor and outdoor use, composed by two bases injected in fibreglass with PP using gas assisted injection moulding technology, joined by an aluminium bar covered by a textured pvc profile. UV Protection. Net weight 4,65 kg (10.25 lb). Compatible base with HPL of 120 x 80 and tempered glass table tops of 120 x 80 cm and 150 x 110 oval. See table combinations on page 162.

Double pied central pour usage intérieur et extérieur, composé par deux bases injectées en fibre de verre avec PP, en utilisant technologie de moulage assistée par gaz, unies par une barre en aluminium couverte avec un profil de pvc texturé. Protection UV. Poids net 4,65 kg. Pied compatible avec plateaux de résine phénolique de 120 x 80 et verre trempé de 120 x 80 et 150 x 110 ovale. Voir table de combinaisons à la page 162.

W 61,5 cm | W 24.21 in  
L 79 cm | L 31.10 in  
H 72,5 cm | H 28.54 in

W: ancho / width / largeur. L: largo / length / longueur  
H: altura / height / hauteur. Hs: altura asiento / seat height / hauteur du siège. Ha: altura brazo / arm height / hauteur du bras  
Ø: diámetro / diameter / diamètre.

STD units	Packaging dim. (cm)	M3/ pack	NW units (kg)	Units Container 20'	Units Container 40'	Units Container HC	Units Truck 70m³	Units Truck 100m³
1	83x74x27	0,16	4,65	-	-	-	-	-

# VELA L

FABRIZIO BATONI

Pie  
Pedestal base  
Pied

- Blanco | White | Blanc
- Negro | Black | Noir
- Rojo | Red | Rouge
- Arena | sand | sable

 Certificados | Certificates | Certificats

Vela pedestal base Test Certificates:  
EN 15372 L3



Pie central doble para uso interior y exterior compuesto por dos bases inyectadas en fibra de vidrio con PP mediante tecnología de moldeo asistida por gas, enlazadas entre sí por una barra de aluminio cubierto por un perfil de pvc texturizado. Protección UV. Peso neto 5,9 kg. Base compatible con sobres de compacto fenólico de 180 x 90 y 200 x 90, y cristal templado de 180 x 90 cm. Ver tabla de combinaciones en página 162.

Double pedestal base for indoor and outdoor use, composed by two bases injected in fibreglass with PP using gas assisted injection moulding technology, joined by an aluminium bar covered by a textured pvc profile. UV Protection. Net weight 5,9 kg (13 lb). Compatible base with HPL table tops of 180 x 90 and 200 x 90, and tempered glass table tops of 180 x 90 cm. See table combinations on page 162.

Pied central double pour usage intérieur et extérieur, composé par deux bases injectées en fibre de verre avec PP, en utilisant technologie de moulage assistée par gaz, unies par une barre en aluminium couverte avec un profil de pvc texturé. Protection UV. Poids net 5,9 kg. Pied compatible avec plateaux de résine phénolique de 180 x 90 et 200 x 90, et de verre trempé de 180 x 90. Voir table de combinaisons à la page 162.

W 61,5 cm	W 24.21 in
L 142 cm	L 55.91 in
H 72,5 cm	H 28.54 in

W: ancho / width / largeur. L: largo / length / longueur  
H: altura / height / hauteur. Hs: altura asiento / seat height / hauteur du siège. Ha: altura brazo / arm height / hauteur du bras  
Ø: diámetro / diameter / diamètre.

STD units	Packaging dim. (cm)	M3/ pack	NW units (kg)	Units Container 20'	Units Container 40'	Units Container HC	Units Truck 70m²	Units Truck 100m²
1	83x74x27	0,16	5,9	-	-	-	-	-

# BARCINO

JOAN GASPAR

Mesa apilable  
Stackable table  
Table empilable

 Apilable  
10u. Stackable | Empilable

Personalización de colores disponible bajo pedido y sujetos a cantidades mínimas. Consulte el Departamento Comercial.

Colour customization is available upon request. Minimum orders are applicable. Contact the Sales Department.

Personnalisation de couleurs disponible sur commande. Quantités minimales à appliquer. Consultez le Département Commerciale.

- Arena | sand | sable
- Negro | Black | Noir
- Blanco | White | Blanc

 Certificados | Certificats | Certificats

Barcino table Test Certificates:  
UNE N 581 PUBLIC



Mesa apilable para uso interior y exterior. Estructura de aluminio anodizado pintado por pulverización y secado al horno de 40 x 40 mm y 1,50 mm de grosor. Sobre de 3 mm de grosor. Peso neto mesa 70 x 70, 8 kg. Peso neto mesa 90x90, 11 kg.

Stackable table for indoor and outdoor use. Powder coated anodized aluminium frame and oven-drying 40 x 40 mm and 1,50 mm thick. Table top of 3 mm thickness. 70 x 70 table net weight 8 kg (17.64 lb). 90 x 90 table net weight 11 kg (24,26 lb).

Table empilable pour usage intérieur et extérieur. Structure en aluminium anodisé peinte par pulvérisation et séchée au four 40 x 40 mm et 1,50 mm de grosseur. Plateau de 3 mm de grosseur. Poids net table 70 x 70 8 kg. Poids net table 90 x 90 11 kg.

W 70 cm | W 27.56 in  
L 70 cm | L 27.56 in  
H 74 cm | H 29.13 in

W 90 cm | W 35.43 in  
L 90 cm | L 35.43 in  
H 74 cm | H 29.13 in

W: ancho / width / largeur. L: largo / length / longueur  
H: altura / height / hauteur. Hs: altura asiento / seat height / hauteur du siège. Ha: altura brazo / arm height / hauteur du bras  
Ø: diámetro / diameter / diamètre.

STD units	Packaging dim. (cm)	M3/ pack	NW units (kg)	Units Container 20'	Units Container 40'	Units Container HC	Units Truck 70m <sup>3</sup>	Units Truck 100m <sup>3</sup>
1	80x89x120	0,58	8	200	480	480	520	600
20	100x100x220	2,2	8	200	480	480	520	600
1	100x89x120	1,07	11	200	480	480	520	600
20	120x120x220	3,6	11	200	480	480	520	600

# BARCINO COMPACT

JOAN GASPAR

Mesa Apilable  
Stackable table  
Table empilable

 Apilable  
10u. Stackable | Empilable

Personalización de colores disponible bajo pedido y sujetos a cantidades mínimas. Consulte el Departamento Comercial.

Colour customization is available upon request. Minimum orders are applicable. Contact the Sales Department.

Personnalisation de couleurs disponible sur commande. Quantités minimales à appliquer. Consultez le Département Commerciale.

 Estructura | Structure | Structure

Blanco | White | Blanc  
 Negro | Black | Noir

Tablero | Table top | Plateau

Blanco | White | Blanc  
 Negro | Black | Noir  
 Madera lavada | Washed wood | Bois délavé  
 Roble natural | Natural oak | Chêne naturele  
 Roble ceniza | Ashen oak | Chêne cendré

W 70 cm | W 27.56 in  
L 70 cm | L 27.56 in  
H 74 cm | H 29.13 in

W: ancho / width / largeur. L: largo / length / longueur  
H: altura / height / hauteur. Hs: altura asiento / seat height / hauteur du siège. Ha: altura brazo / arm height / hauteur du bras  
Ø: diámetro / diameter / diamètre.



Mesa apilable para uso interior y exterior. Estructura de aluminio anodizado pintado por pulverización y secado al horno de 40 x 40 mm y 1,50 mm de grosor. Tablero de compacto fenólico de 10 mm de grosor. Peso neto 10,68 kg.

Stackable table for indoor and outdoor use. Powder coated anodized aluminium frame and oven-drying 40 x 40 mm and 1,50 mm thick. Table top of HPL of 10 mm thickness. Net weight (10,68 kg) 23.55 lb.

Table empilable pour usage intérieur et extérieur. Structure en aluminium anodisé peinte par pulvérisation et séchée au four 40 x 40 mm et 1,50 mm de grosseur. Plateau en résine phénolique de 10 mm de grosseur. Poids net 10,68 kg.

STD units	Packaging dim. (cm)	M3/ pack	NW units (kg)	Units Container 20'	Units Container 40'	Units Container HC	Units Truck 70m <sup>3</sup>	Units Truck 100m <sup>3</sup>
1	80x89x120	0,85	10,68	180	432	432	468	540
18	100x100x220	2,2	10,68	180	432	432	468	540



# CORNER

BARCELONA Dd

Pie  
Pedestal  
Pied

 Apilable  
Stackable | Empilable

- Blanco | White | Blanc
- Arena | Sand | Sable
- Gris Oscuro | Dark Grey | Gris Foncé







Mesa Corner con patas inyectadas en polipropileno con fibra de vidrio mediante tecnología de moldeo asistida por gas. Altura 73,5 cm. Combinables con sobre de compacto fenólico en distintas medidas. Posibilidad en 3 o 4 patas según medida del sobre.

Corner table with legs injected in polypropylene with fiberglass using gas assisted molding technology. High 73,5 cm (28.93 in). Combinables with HPL top in different sizes. Possibility in 3 or 4 legs according to the size of the top.

Table Corner avec pieds injectés en polypropylène et fibre de verre à travers la technologie de moulage assistée par gaz. Hauteur 73,5 cm. Combinables avec des plateaux en compact phénolique de différentes dimensions. Possibilité de 3 ou 4 pieds selon la dimension du plateau.

STD units	Packaging dim. (cm)	M3/ pack	NW units (kg)	Units Container 20'	Units Container 40'	Units Container HC	Units Truck 70m³	Units Truck 100m³
3 Legs	84x83x17	0,12	3,6	765	1.575	1.800	2.100	2.400
4 Legs	84x83x17	0,12	4,8	1.020	2.100	2.400	2.800	3.200

## COMBINACIONES DE MESAS | TABLE COMBINATIONS | COMBINAISONS DE TABLES

Medidas Measurements Mesures	Ø 60	Ø 70	Ø 80	Ø 90	70x70	80x80	90x90	120x80
Material Material Matériel								
Patas   legs   pieds	3	3	4	4	4	4	4	4
HPL 	•	•			•			
	•	•			•			
HPL MADERA HPL Wood HPL Bois								
A 	•	•	•	•	•	•	•	•
B 	•	•	•	•	•	•	•	•
C 	•	•	•	•	•	•	•	•

- A - Roble natural | natural oak | chêne naturel
- B - Roble ceniza | ashen oak | chêne cendré
- C - Madera lavada | Washed wood | Bois delavé





Silla Toledo Aire (p. 26), mesa Corner (p. 148)  
Toledo Aire chair (p. 26), Corner table (p. 148)  
Chaise Toledo Aire (p. 26), table Corner (p. 148)



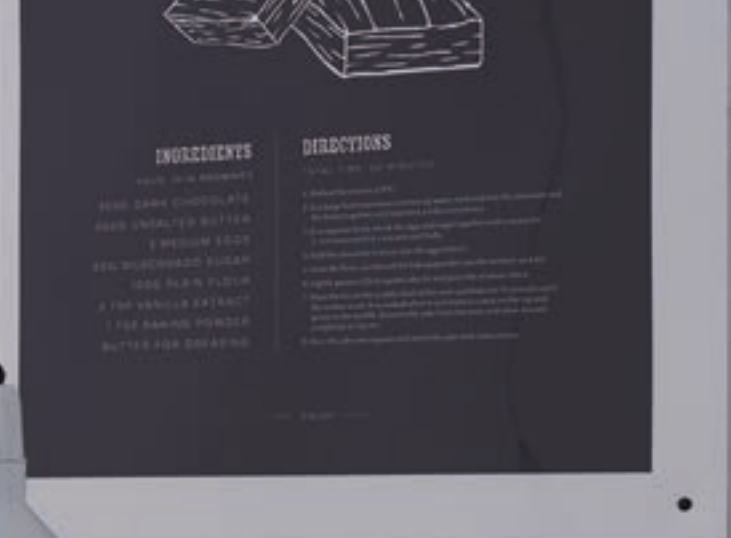



# POINT

JOAN GASPAR

Mesa  
Table  
Table

 Apilable  
10u. Stackable | Empilable

- Blanco/Rojo | White/Red | Blanc/Rouge
- Blanco/Negro | White/Black | Blanc/Noir
- Blanco | White | Blanc



 Certificados | Certificats | Certificats

Point table Test Certificates:  
EN 16139 L1 / EN 581 PUBLIC



Mesa para uso interior y exterior. El sobre se compone de 2 partes inyectadas en PP. Estructura tubular de acero pintado por pulverización al horno, disponible en color blanco. Apilable. Protección UV. Peso neto 70 x 70: 10,66 kg y peso neto 80 x 80: 12 kg.

Table for indoor and outdoor use. The table top is composed by two layers injected in PP. Tubular powder coated steel structure, available in white. Stackable. UV protection. Net Weight 70 x 70: 10,66 kg (23.50 lb) and net weight 80 x 80: 12 kg (26.46 lb).

Table d'intérieur et extérieur. Le plateau est fait en deux parties injectées en PP. Structure tubulaire en acier peint par pulvérisation, disponible en couleur blanche. Empilable. Protection UV. Poids net 70 x 70: 10,66 kg et poids net 80 x 80: 12 kg.

W 70 cm | W 27.56 in  
L 70 cm | L 27.56 in  
H 70,5 cm | H 27.76 in

W 80 cm | W 31.50 in  
L 80 cm | L 31.50 in  
H 70,5 cm | H 27.76 in

W: ancho / width / largeur. L: largo / length / longueur  
H: altura / height / hauteur. Hs: altura asiento / seat height / hauteur du siège. Ha: altura brazo / arm height / hauteur du bras  
Ø: diámetro / diameter / diamètre.

STD units	Packaging dim. (cm)	M3/ pack	NW units (kg)	Units Container 20'	Units Container 40'	Units Container HC	Units Truck 70m³	Units Truck 100m³
15	110x110x210	2,54	10,66	150	300	330	360	390
15	110x110x210	2,54	12	150	300	330	360	390



Sillas Sun (p. 121) con mesa Point (p. 152)

Sillas Sun (p. 121) con mesa Point (p. 152)

Chaises Sun (p. 121) avec table Point (p. 152)

Los precios pueden estar desactualizados. Llámanos al 91 161 03 04 para consultar los precios en vigor.

# NOA

DAVID CARRASCO BARCELÓ

Mesa  
Table  
Table

Sobre + patas | Table + legs |  
Plateau + pieds

- Blanco | White | Blanc
- Arena | Sand | Sable
- Arena/Blanco | Sand/White | Sable/Blanc
- Gris Oscuro | Dark Grey | Gris Foncé
- Gris Oscuro/Blanco | Dark Grey/White | Gris Foncé/Blanc
- Rojo | Red | Rouge
- Chocolate | Chocolate | Chocolat
- Chocolate/ Blanco | Chocolate/ White | Chocolat/ Blanc



Certificados | Certificates | Certificats

Noa Table Test Certificates:  
EN 581-1 / 581-3 PUBLIC



Mesa para uso interior y exterior inyectada en polipropileno y reforzada con fibra de vidrio en las patas. Protección UV. Disponible en dos medidas: 90x90, peso neto 11,85 kg (26.12 lb), 160 x 90, peso neto 21,65 kg (47.73 lb).

Table for indoor and outdoor use injected in polypropylene and reinforced with fiberglass in the legs. UV protection. Available in 2 sizes: 90x90, net weight 11,85 kg (26.12 lb), 160 x 90, net weight 21,65 kg (47.73 lb).

Table pour usage intérieur et extérieur injecté en polypropylène et renforcé de fibre de verre dans les pieds. Protection UV. Disponible en deux dimensions: 90x90, poids net 11,85 kg (26.12 lb), 160 x 90, poids net 21,65 kg (47.73 lb).

W 90 cm	W 35.43 in
L 90 cm	L 35.43 in
H 74 cm	H 29.13 in

W 90 cm	W 35.43 in
L 160 cm	L 62.99 in
H 74 cm	H 29.13 in

W: ancho / width / largeur. L: largo / length / longueur  
H: altura / height / hauteur. Hs: altura asiento / seat height / hauteur du siège. Ha: altura brazo / arm height / hauteur du bras  
Ø: diámetro / diameter / diamètre.

STD units	Packaging dim. (cm)	M3/ pack	NW units (kg)	Units Container 20'	Units Container 40'	Units Container HC	Units Truck 70m³	Units Truck 100m³
1	94x92x15	0,13	12,07	180	390	442	448	578
24	100x100x220	2,2	11,85	240	240	576	624	720
1	161x92x15	0,22	18,27	90	210	238	256	323
24	100x160x220	3,52	21,65	168	384	384	408	504





Sillas y sillas con brazos Ona (p. 110-111), mesa Noa (p. 154)

Ona chairs and armchairs (p. 110-111), Noa table (p. 154)

Fauteuils et chaises Ona (p. 110-111), Noa table (p. 154)

Los precios pueden estar desactualizados. Llámamos al 91 161 03 04 para consultar los precios en vigor.



# NEW DESSA

BARCELONA Dd

Mesa  
Table  
Table

- Blanco | White | Blanc
- Chocolate | Chocolate | Chocolat
- Arena | Sand | Sable
- Gris Oscuro | Dark Grey | Gris Foncé

Certificados | Certificates | Certificats

New Dessa Table Test Certificates:  
EN 581 PUBLIC



Mesa para uso interior y exterior. Sobre y patas inyectados en polipropileno. Estructura de acero zincado pintada por pulverización al horno testeado conforme normativa anticorrosión UNE EN/ISO 9227:2012. Protección UV. Disponible en 2 medidas: 90 x 90, peso neto 11,74 kg, 160 x 90, peso neto 16,75 kg.

Table for indoor and outdoor use. Table top and legs injected in polypropylene. Powder coated zink steel structure in accordance to corrosion regulation UNE EN/ISO 9227:2012. UV protection. Available in 2 sizes: 90 x 90, net weight 11,74 kg (25.88 lb), 160 x 90, net weight 16,75 kg (36,93 lb).

Table pour usage intérieur et extérieur. Plateau et pieds injectés en polypropylène. Structure d'acier zingué peint par pulvérisation au four en conformité avec la réglementation anticorrosion UNE EN/ISO 9227:2012. Disponible dans 2 mesures: 90 x 90, poids net 11,74 kg, 160 x 90, poids net 16,75 kg.

W 90 cm	W 35.43 in
L 90 cm	L 35.43 in
H 74 cm	H 29.13 in

W 90 cm	W 35.43 in
L 160 cm	L 62.99 in
H 74 cm	H 29.13 in

W: ancho / width / largeur. L: largo / length / longueur  
H: altura / height / hauteur. Hs: altura asiento / seat height / hauteur du siège. Ha: altura brazo / arm height / hauteur du bras  
Ø: diámetro / diameter / diamètre.

STD units	Packaging dim. (cm)	M3/ pack	NW units (kg)	Units Container 20'	Units Container 40'	Units Container HC	Units Truck 70m <sup>3</sup>	Units Truck 100m <sup>3</sup>
1	94x92x15	0,13	11,74	180	390	442	448	578
1	161x92x15	0,22	16,75	90	210	238	256	323

# NEW FLASH

## BARCELONA Dd

Mesa  
Table  
Table

- Blanco | White | Blanc
- Chocolate | Chocolate | Chocolat
- Arena | Sand | Sable
- Gris Oscuro | Dark Grey | Gris Foncé

 Certificados | Certificates | Certificats

New Flash Table Test Certificates:  
EN 581 PUBLIC



Mesa para uso interior y exterior. Sobre inyectado en polipropileno. Patas de aluminio anodizado de alta resistencia. Estructura de acero zincado pintada por pulverización al horno testeado conforme normativa anticorrosión UNE EN/ISO 9227:2012. Protección UV. Disponible en 2 medidas: 90 x 90, peso 11,58 kg, 160 x 90, peso 16,59 kg.

Table for indoor and outdoor use. Table top injected with polypropylene. High resistance anodized aluminium legs. Powder coated zinc steel structure in accordance to corrosion regulation UNE EN/ISO 9227:2012. UV Protection. Available in two sizes: 90 x 90, weight 11,58 kg (25.53 lb), 160 x 90, weight 16,59 kg (36,57 lb).

Table d'intérieur et extérieur. Plateau injecté en polypropylène. Pieds en aluminium anodisé de haute résistance. Structure d'acier zingué peint par pulvérisation au four en conformité avec la réglementation anticorrosion UNE EN/ISO 9227:2012. Protection UV. Disponible dans 2 mesures: 90 x 90, poids 11,58 kg, 160 x 90, poids 16,59 kg.

W 90 cm | W 35.43 in  
L 90 cm | L 35.43 in  
H 74 cm | H 29.13 in

W 90 cm | W 35.43 in  
L 160 cm | L 62.99 in  
H 74 cm | H 29.13 in

W: ancho / width / largeur. L: largo / length / longueur  
H: altura / height / hauteur. Hs: altura asiento / seat height / hauteur du siège. Ha: altura brazo / arm height / hauteur du bras  
Ø: diámetro / diameter / diamètre.

STD units	Packaging dim. (cm)	M3/ pack	NW units (kg)	Units Container 20'	Units Container 40'	Units Container HC	Units Truck 70m <sup>3</sup>	Units Truck 100m <sup>3</sup>
1	94x92x15	0,13	11,58	180	390	442	448	578
1	161x92x15	0,22	16,59	90	210	238	256	323

# BARCINO

JOAN GASPAR

Mesa pie central alto  
High pedestal base table  
Table pied central haute

Personalización de colores disponible bajo pedido y sujetos a cantidades mínimas. Consulte el Departamento Comercial.

Colour customization is available upon request. Minimum orders are applicable. Contact the Sales Department.

Personnalisation de couleurs disponible sur commande. Quantités minimales à appliquer. Consultez le Département Commerciale.

- Arena | sand | sable
- Negro | Black | Noir
- Blanco | White | Blanc



 **Certificados** | Certificates | Certificats

Barcino table Test Certificates:  
EN 581 PUBLIC



Mesa alta para uso interior y exterior. Estructura de aluminio anodizado pintado por pulverización y secado al horno. Sobre de 4 mm de grosor. Base de Ø 35 cm y tubo de Ø 6 cm. Peso neto mesa 14 kg.

High table for indoor and outdoor use. Powder coated anodized aluminium frame and oven-drying. Table top of 4 mm thickness. Base of Ø 35 cm and tube of Ø 6 cm. Table net weight 14 kg (30.86 lb).

Table pour usage intérieur et extérieur. Structure en aluminium anodisé peinte par pulvérisation et séchée au four. Plateau de 4 mm de grosseur. Base de Ø 35 cm avec tube de Ø 6 cm. Poids net table 14 kg.

Ø 60 cm | Ø 23.62 in  
H 110 cm | H 43.31 in

**W:** ancho / width / largeur. **L:** largo / length / longueur  
**H:** altura / height / hauteur. **Hs:** altura asiento / seat height / hauteur du siège. **Ha:** altura brazo / arm height / hauteur du bras  
**Ø:** diámetro / diameter / diamètre.

STD units	Packaging dim. (cm)	M3/ pack	NW units (kg)	Units Container 20'	Units Container 40'	Units Container HC	Units Truck 70m³	Units Truck 100m³
1	62x62x13	0,05	14	297	675	675	800	-

# SPUTNIK

JOSEP LLUSCÀ

Pie alto  
High pedestal base  
Pied haut

- Blanco | White | Blanc
- Rojo | Red | Rouge
- Negro | Black | Noir

Acabados tubos | Tubes finishes |  
Finition du tube

- Aluminio brillante | Shiny Aluminium |  
Aluminium brillant
- Aluminio mate | Matt Aluminium |  
Aluminium mat
- Aluminio pintado blanco |  
White painted Aluminium |  
Aluminium peint en blanc
- Aluminio pintado negro |  
Black painted Aluminium |  
Aluminium peint en noir



Pie central alto para uso interior y exterior. El pie se compone de dos partes, una carcasa inyectada en poliamida y un contrapeso de hierro pintado. Tubo de aluminio anodizado de  $\varnothing 60 \times 2$  mm. de grosor en acabado brillante, mate o pintado blanco o negro. Protección contra rayos UV. Nivelador en una pata. Consultar tabla de combinaciones de pie y sobres en pág. 162.

High pedestal base for indoor and outdoor use. The base is composed of two pieces, a casing injected with polyamide and a painted iron counterweight. Anodized aluminium tube,  $\varnothing 60 \times 2$  mm thick, shiny, matt or white or black painted finish. UV protection. Leveller in one leg. See table combination for pedestal bases and table tops on p. 162.

Pied central haut d'intérieur et extérieur. Pied central fait en deux partis, une carcasse injectée en polyamide et un contrepoids en fer, peint. Tube en aluminium anodisé brillant ou mat, ou tube en aluminium peint blanc ou noir de  $\varnothing 60 \times 2$  mm de grosseur. Protection contre les rayons UV. Niveleur sur un pied. Voir table de combinaisons entre pied central et plateau à la page 162.

W 52 cm | W 20.47 in  
L 52 cm | L 20.47 in  
H 107 cm | H 42.12 in

W: ancho / width / largeur. L: largo / length / longueur  
H: altura / height / hauteur. Hs: altura asiento / seat height /  
hauteur du siège. Ha: altura brazo / arm height / hauteur du bras  
Ø: diámetro / diameter / diamètre.

STD units	Packaging dim. (cm)	M3/ pack	NW units (kg)	Units Container 20'	Units Container 40'	Units Container HC	Units Truck 70m <sup>3</sup>	Units Truck 100m <sup>3</sup>
1	box1: 53x55x17	0,075	6,78	350	725	822	875	1.250
	box 2: 96x7x7	0,005						



# TABLERO COMPACTO FENÓLICO

## HPL TABLE TOP

### PLATEAU RÉSINE PHÉNOLIQUE

El compacto fenólico es un laminado de alta presión (HPL). Su composición consiste en capas de papel aglutinado con resinas termoestables de melamina-formaldehído en su superficie y de fenol-formaldehído en su interior. Todo ello es prensado a alta presión ( $\geq 7$  MPa) y alta temperatura ( $\geq 120^\circ\text{C}$ ), dando como resultado uno de los materiales más versátiles por su apariencia, estética, resistencia y durabilidad.

Su extraordinaria superficie está constituida por una hoja impregnada con resina de melamina-formaldehído, que es la que aporta el diseño. Por encima de este diseño decorativo lleva una hoja adicional (overlay), impregnada también en resina melamínica, que le aporta gran resistencia al rayado y la abrasión. Finalmente, el núcleo central, compuesto de papel kraft impregnado en resina fenólica, le dotan de gran resistencia al impacto. Tanto el overlay como el núcleo central de resina fenólica, son los dos elementos diferenciadores del laminado HPL.

El laminado HPL posee la cualidad de ser resistente al calor, al rayado, a la abrasión, impermeable e inerte debido a su superficie no porosa, lo cual lo hace apto para uso interior y exterior e ideal para uso contract.

HPL is a high pressure laminate (HPL). Its composition is bonded paper layers with thermosetting resins, melamine-formaldehyde on its surface and phenol-formaldehyde inside. All this is pressed at high pressure ( $\geq 7$  MPa) and high temperature ( $\geq 120^\circ\text{C}$ ), resulting in one of the most versatile materials in appearance, aesthetics, strength and durability.

Its extraordinary surface is constituted by a sheet impregnated with melamine-formaldehyde resin, which gives it a unique design. Above this decorative design it has an additional sheet (overlay) that's also impregnated with melamine resin, which makes it highly resistant to scratches and abrasion. Finally, the central core, consisting of kraft paper impregnated with phenolic resin, provide it with high impact resistance. Both the overlay and the core of phenolic resin are the two distinguishing features of HPL.

The HPL has the peculiarity of being resistant to heat, scratch, abrasion, waterproof and inert due to its non-porous surface, making it suitable for indoor and outdoor use and ideal for contract use.

La résine phénolique est un stratifié compact (HPL) de haute pression. Sa composition est constituée de couches de papier avec des résines thermodurcissables, des résines mélamine-formaldéhyde, sur sa surface et de phénol-formaldéhyde à l'intérieur. Tout cela est pressé à haute pression ( $\geq 7$  MPa) et haute température ( $\geq 120^\circ\text{C}$ ), résultant un des matériaux les plus polyvalents pour son apparence, esthétique, solidité et durabilité.

Sa surface extraordinaire est constituée par une feuille imprégnée de résine mélamine-formaldéhyde, qui elle même apporte son dessin. Au-dessus de ce dessin décoratif, s'ajoute une feuille supplémentaire (overlay) imprégnée de résine mélamine également, ce qui donne une haute résistance les rayures et l'abrasion. Enfin, le noyau central, composé de papier kraft imprégné de résine phénolique, lui permet une résistance aux chocs élevée. Autant la superposition comme le noyau de résine phénolique sont les deux traits distinctifs de HPL.

Le HPL a la qualité d'être résistant à la chaleur, aux égratignures, à l'abrasion, imperméable à l'eau et inerte en raison de sa surface non poreuse, ce qui convient pour usage intérieur et extérieur et idéal pour une utilisation contrat.



Blanco | White | Blanc



Negro | Black | Noir

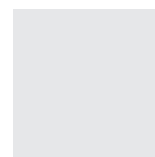

Plata | Silver | Argent

Ø 60 cm H 1 cm	Ø 23.62 in H 0.40 in	Ø 70 cm H 1 cm	Ø 27.56 in H 0.40 in
-------------------	-------------------------	-------------------	-------------------------

Ø 80 cm H 77,7 cm	Ø 31.49 in H 0.40 in	L60 cm W 60 cm H 1 cm	L 23.62 in W 23.62 in H 0.40 in
----------------------	-------------------------	-----------------------------	---------------------------------------

L 70 cm W 70 cm H 1 cm	L 27.56 in W 27.56 in H 0.40 in	L 80 cm W 80 cm H 1 cm	L 31.49 in W 31.49 in H 0.40 in
------------------------------	---------------------------------------	------------------------------	---------------------------------------

L 90 cm W 90 cm H 1 cm	L 35.43 in W 35.43 in H 0.40 in	L 120 cm W 80 cm H 1 cm	L 47.24 in W 31.49 in H 0.40 in
------------------------------	---------------------------------------	-------------------------------	---------------------------------------

L 180 cm W 90 cm H 1 cm	L 70.87 in W 35.43 in H 0.40 in	L 200 cm W 90 cm H 1 cm	L 78.74 in W 35.43 in H 0.40 in
-------------------------------	---------------------------------------	-------------------------------	---------------------------------------



Madera lavada | Washed Wood | Bois Delavé



Roble Ceniza | Ashen Oak | Chêne Cendré



Roble Natural | Natural Oak | Chêne Naturel

L 70 cm W 60 cm H 1 cm	L 27.56 in W 23.62 in H 0.40 in	L 70 cm W 70 cm H 1 cm	L 27.56 in W 27.56 in H 0.40 in
------------------------------	---------------------------------------	------------------------------	---------------------------------------

L 80 cm W 80 cm H 1 cm	L 31.49 in W 31.49 in H 0.40 in	L 90 cm W 90 cm H 1 cm	L 35.43 in W 35.43 in H 0.40 in
------------------------------	---------------------------------------	------------------------------	---------------------------------------

L 120 cm W 80 cm H 1 cm	L 47.24 in W 31.49 in H 0.40 in	L 180 cm W 90 cm H 1 cm	L 70.87 in W 35.43 in H 0.40 in
-------------------------------	---------------------------------------	-------------------------------	---------------------------------------

Ø 80 cm H 1 cm	Ø 34.49 in H 0.40 in
-------------------	-------------------------

Cualquier otro color bajo pedido y plazo de entrega. Consultar Departamento Comercial. Any other colour upon request, delivery time varies. Ask the Sales Department.

N'importe quelle couleur sur commande et délai de livraison. Consulter le Département Commercial.

# TABLERO WERZALIT®

## WERZALIT® TABLE TOP

### PLATEAU WERZALIT®

Los tableros Werzalit se fabrican según un procedimiento patentado especialmente para su uso en interiores y exteriores. Debido al núcleo del material altamente triturado y prensado y con la superficie prensada homogéneamente con materiales derivados de la madera, los tableros Werzalit logran una larga vida útil, son sumamente sólidos y totalmente resistentes a la intemperie. No se recomienda exponer el werzalit en colores oscuros directamente al sol para evitar que se curve o deforme por efecto de la acumulación de calor.

Werzalit table tops are manufactured specially for use inside and outside using a patented procedure. Due to its high density material core manufactured from naturally grown wood and the surface pressed homogeneously with the wood material, Werzalit table tops are durable, hard-wearing and completely weatherproof. We do not recommend to expose dark werzalit table tops to the sun in order to avoid curving or deforming through the effect of heat accumulation.

Les plateaux de tables Werzalit sont fabriqués selon un procédé breveté en particulier pour un usage intérieur comme extérieur. Grâce à son noyau de haute densité avec particules de bois compressées et homogènes, les plateaux de tables Werzalit sont durables, robustes et absolument résistant aux intempéries. Nous recommandons de ne pas exposer les plateaux Werzalit foncés directement au soleil afin d'éviter qu'ils se courbent et se déforment par l'accumulation de chaleur.



Cualquier otro color bajo pedido y plazo de entrega. Consultar Departamento Comercial.

Any other colour upon request, delivery time varies. Ask the Sales Department.

N'importe quelle couleur sur commande et délai de livraison. Consulter le Département Commercial.



Otros colores o medidas, consultar con el departamento comercial.

For other colours or sizes please consult commercial department.

Plusieurs couleurs, consulter le département commercial.

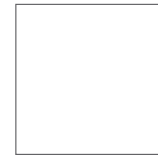

Blanco | White | Blanc

Ø 60 cm	Ø 23.62 in	W 60 cm L 60 cm	W 23.62 in L 23.62 in
W 70 cm L 70 cm	W 27.56 in L 27.56 in	W 80 cm L 80 cm	W 31.49 in L 31.49 in
W 90 cm L 90 cm	W 35.43 in L 35.43 in	W 120 cm L 80 cm	W 47.24 in L 31.49 in
W 56,1 cm L 56,4 cm H 77,7 cm	W 22.09 in L 22.20 in H 30.59 in	W 56,1 cm L 56,4 cm H 77,7 cm	W 22.09 in L 22.20 in H 30.59 in



Stratos | Stratos | Stratos

Ø 60 cm	Ø 23.62 in	W 70 cm L 70 cm	W 27.56 in L 27.56in
W 80 cm L 80 cm	W 31.49 in L 31.49 in	W 120 cm L 80 cm	W 47.24 in L 31.49 in



Wengé | Wenge | Wenge

Ø 60 cm	Ø 23.62 in	W 70 cm L 70 cm	W 27.56 in L 27.56in
W 80 cm L 80 cm	W 31.49 in L 31.49 in	W 120 cm L 80 cm	W 47.24 in L 31.49 in

# TABLERO DUROLIGHT

## DUROLIGHT TABLE TOP

### PLATEAU DUROLIGHT

Los tableros DUROLight son por su resistencia una opción idónea para el uso interior, y perfectamente combinable con la gama de sillas de Resol Contract. Están realizados de melamina con una imprimación de resina en la superficie que los protege de arañazos y de altas temperaturas (hasta 180°C). Los cantos están sellados con ABS para garantizar un acabado perfecto y resistente (Pruebas realizadas demuestran que son necesarios más de 1.5 Newton para conseguir arañar la superficie y 350 rotaciones para que se experimente desgaste.) Disponibles en color wengé, pino vintage y blanco.

The DUROLight tabletops are an ideal option for indoor use due to their resistance, and perfectly combinable with the range of Resol Contract. They are made of melamine with a resin coating on the surface, which protects them from scratches and high temperatures (up to 180°C). The edges are ABS sealed in order to guarantee a perfect and resistant finish. (Tests carried out showed that more than 1.5 Newton is necessary to achieve scratching the surface and 350 rotations in order to show wear.) Available in the colours wenge, vintage pine and white.

La résistance des planches DUROLight en fait l'option idéale pour un usage intérieur, et pouvant être parfaitement combinées avec la gamme de Resol Contract. Ils sont fabriqués en mélamine avec une couche de résine en surface protégeant des rayures et des hautes températures (jusqu'à 180°C) Les bords sont collés par ABS afin de garantir une finition parfaite et résistante. (Les tests réalisés démontrent qu'il faut plus de 1,5 Newton pour parvenir à rayer la surface et 350 rotations pour que l'usure commence.) Couleurs disponibles: wengé, pin vintage et blanc.



Standard  
Wengé | Wenge | Wenge

W 68 cm	W 26.77 in	W 80 cm	W 31.49 in
L 68 cm	L 26.77 in	L 80 cm	L 31.49 in
H 5 cm	H 1.97 in	H 5 cm	H 1.97 in



Standard  
Blanco | White | Blanc

W 68 cm	W 26.77 in	W 80 cm	W 31.49 in
L 68 cm	L 26.77 in	L 80 cm	L 31.49 in
H 5 cm	H 1.97 in	H 5 cm	H 1.97 in



Standard  
Pino Vintage | Vintage Pine | Pin Vintage

W 68 cm	W 26.77 in	W 80 cm	W 31.49 in
L 68 cm	L 26.77 in	L 80 cm	L 31.49 in
H 5 cm	H 1.97 in	H 5 cm	H 1.97 in



Cualquier otro color bajo pedido y plazo de entrega. Consultar Departamento Comercial.

Any other colour upon request, delivery time varies. Ask the Sales Department.

N'importe quelle couleur sur commande et délai de livraison. Consulter le Département Commercial.



Standard: Acabado de Superficie de Melamina Decorativa + Revestimiento Protector Transparente.

① Standard: Decorative Melamine Surface Finish + Extra Transparent Overlay.

Standard: Finition de surface de mélamine décorative + revêtement protecteur transparent.

Aglomerado de 8 mm.

② 8 mm Chipboard layer.

Agglomérat de 8 mm.

Núcleo Interno Alveolar.

③ Internal Honeycomb core.

Noyau interne alvéolaire.

Canto de Unión de 3 mm de ABS inyectado.

④ 3 mm Support Edge of foamed ABS.

Bord d'union de 3 mm en ABS injecté.

Canto Decorativo de 2 mm de ABS.

⑤ 2 mm ABS Decor Edge.

Bord décoratif de 2 mm en ABS.

# COMBINACIONES DE MESAS | TABLE COMBINATIONS | COMBINAISONS DE TABLES

Material Material Matériel	Medidas Measurements Mesures										
		Vela S	Vela M	Vela L	Net	Sputnik	Sputnik Alto	Sputnik Doble	Drop	Fall	Toledo Aire

## HPL



Ø 60						•	•				
Ø 70	•					•			•	•	•
Ø 80	•					•			•	•	•
Ø 90	•										
Ø 100											
Ø 110											
Ø 120											
60 x 60						•					
70 x 70	•				•				•	•	•
80 x 80	•				•				•	•	•
90 x 90	•				•						
120 x 80			•					•			
180 x 90				•							
200 x 90				•							

## HPL MADERA

HPL Wood  
HPL bois



Ø 80	•					•			•	•	•
Ø 90	•										
70 x 60	•					•			•	•	
70 x 70	•					•			•	•	•
80 x 80	•								•	•	•
90 x 90	•										
120 x 80			•					•			
180 x 90				•							

## WERZALIT

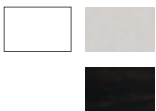

Ø 60						•	•				
60 x 60						•					
70 x 70						•					
80 x 80											
90 x 90											
120 x 80								•			

## DUROLIGHT



68 x 68						•					
80 x 80											

## CRISTAL TEMPLADO



Ø 70	•										
Ø 80	•								•	•	
Ø 90	•										
70 x 70	•										
80 x 80	•										
90 x 90	•										
120 x 80			•								
150 x 110			•								
180 x 90				•							

Las combinaciones disponibles han sido revisadas y aprobadas por el departamento técnico. Para productos destinados a zonas de alta salinidad consultar previamente con departamento comercial / The combinations available have been reviewed and approved by the technical department. Ask previously sales dept. for using our products in high salinity areas/ Les combinaisons disponibles ont été examinées et approuvées par le département technique. Produits destinés aux zones de haute salinité consulter à l'avance au dépt.





Si este documento no incluye las marcas o productos que fabrica o distribuye tu empresa, notifícanoslo en [contacto@hosteleria10.com](mailto:contacto@hosteleria10.com).

Estaremos encantados de incorporarlas.