

# Ficha Técnica

## Cocina Serie 900 EV Planchas rápidas Fry Top a Gas

### Mod. FRT20 / P90 EV

#### Características

Dimensiones exteriores 400 x 900 x 850 mm.

Peso 80 Kg.

Consumo gas Hi (15°C 1013,25 mbar)

Gas natural H G20 Hi = 34.02 MJ / m<sup>3</sup> 0,76

G.P.L. G30 / G31 Hi = 45.65MJ / kg 0,62

Superficie útil 341 x 656 mm.

Tipo superficie Lisa (HIERRO).

Entrada gas 3/4"

Potencia calorífica nominal 9,07 Kw.

**Jemi** Simply built to last

Professional Dishwashing and Cooking Equipment

Selva de Mar, 122-128  
08020 Barcelona, España  
Tel. 0034 93 308 31 54  
Fax. 0034 93 303 38 73  
jemi@jemi.es  
www.jemi.es

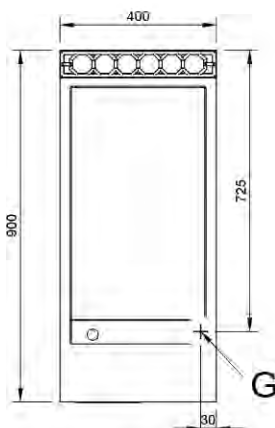
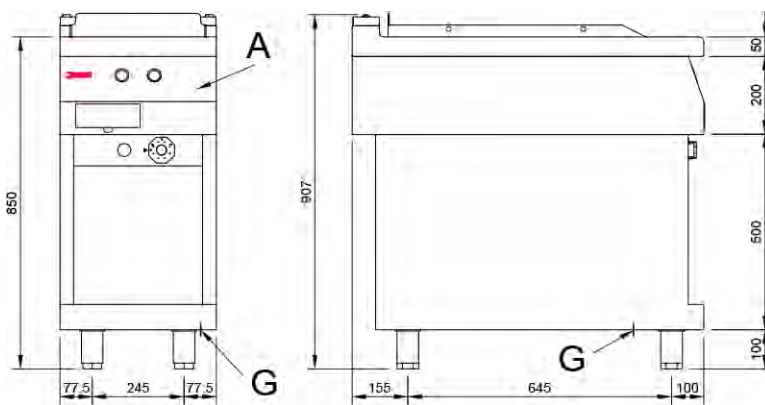

#### Leyenda

- A. Placa de características (frontal interior)
- G. Entrada gas 3/4".  
Potencia: 9,07 Kw.  
7.800 Kcal/h.

# Ficha Técnica

## Cocina Serie 900 EV Planchas rápidas Fry Top a Gas

**Jemi** Simply built to last  
Professional Dishwashing  
and Cooking Equipment

Selva de Mar, 122-128  
08020 Barcelona, España  
Tel. 0034 93 308 31 54  
Fax. 0034 93 303 38 73  
jemi@jemi.es  
www.jemi.es

### Mod. FRT90 / P95 EV

#### Características

Dimensiones exteriores 800 x 900 x 850 mm.

Peso 163 Kg.

Consumo gas Hi (15°C 1013,25 mbar)

Gas natural H G20 Hi = 34.02 MJ / m<sup>3</sup> 1,52

G.P.L. G30 / G31 Hi = 45.65MJ / kg 1,24

Superficie útil 741 x 656 mm.

Tipo superficie Lisa (HIERRO).

Entrada gas 3/4"

Potencia calorífica nominal 18,14 Kw.

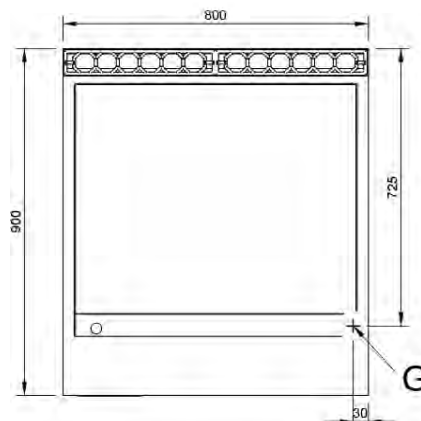
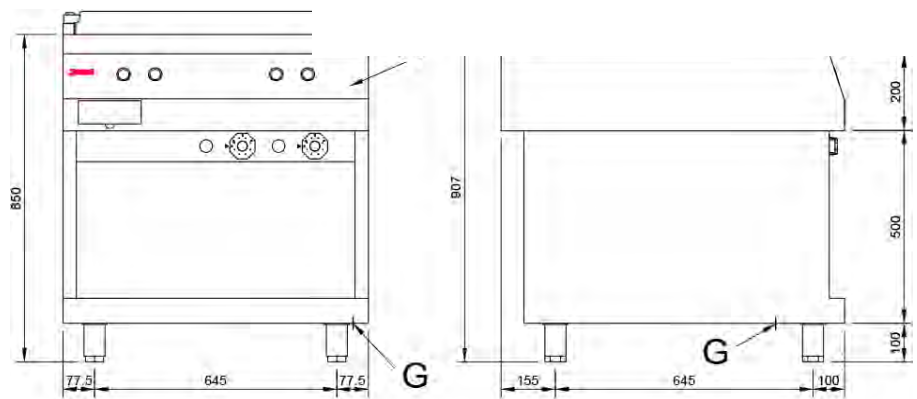

#### Leyenda

A. Placa de características  
(frontal interior)

G. Entrada gas 3/4".  
Potencia: 18,14 Kw.  
15.600 Kcal/h.



# Ficha Técnica

## Cocina Serie 900 EV Planchas rápidas Fry Top a Gas

**Jemi** Simply built to last

Professional Dishwashing and Cooking Equipment

Selva de Mar, 122-128  
08020 Barcelona, España  
Tel. 0034 93 308 31 54  
Fax. 0034 93 303 38 73  
jemi@jemi.es  
www.jemi.es

### Mod. FRT120 / P121 EV

#### Características

Dimensiones exteriores 1200 x 900 x 850 mm.

Peso 253 Kg.

Consumo gas Hi (15°C 1013,25 mbar)

Gas natural H G20 Hi = 34.02 MJ / m<sup>3</sup> 2,28

G.P.L. G30 / G31 Hi = 45.65MJ / kg 1,86

Superficie útil 1141 x 656 mm.

Tipo superficie Lisa (HIERRO).

Entrada gas 3/4"

Potencia calorífica nominal 27,21 Kw.

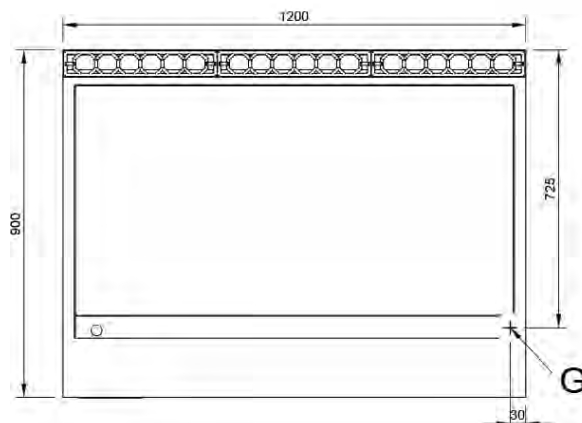
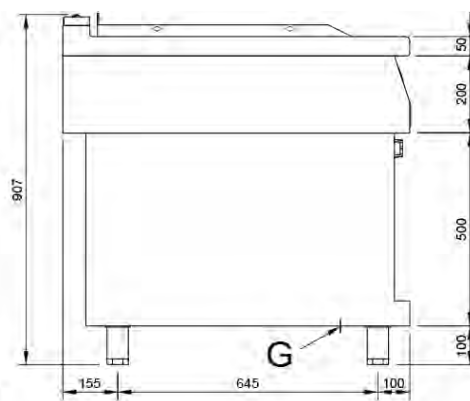
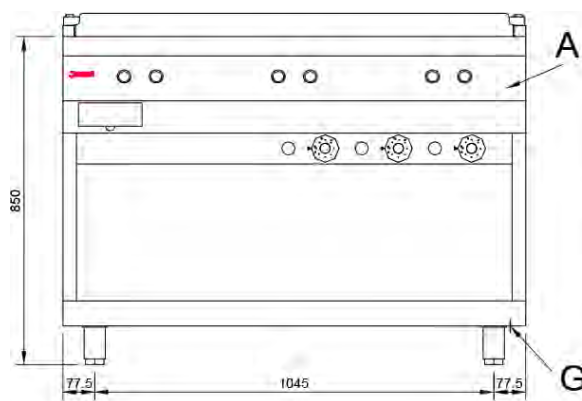

#### Leyenda

A. Placa de características  
(frontal interior)

G. Entrada gas 3/4"  
Potencia: 27,21 Kw.  
23.400 Kcal/h.

