



Catálogo de las
VITRINAS PASTELERAS
distribuidas en España

Vitrina expositora modular serie 9 SELECTA PASTELERÍA con reserva
 Serve over counter modular line 9 PASTRY SELECTA with cold storage

7

all photos must be considered as a reference - fotografías no contractuales

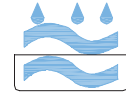

DE SERIE
 STANDAR



CVP-9-20-C
 lacado
 lacquered



CVP-9-20-CC
 madera
 wood

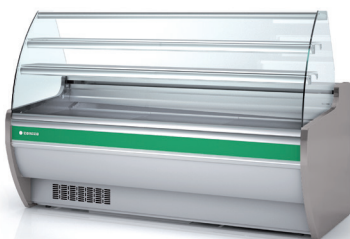

frente un color
 one color front decor



frontal decorado
 front decor

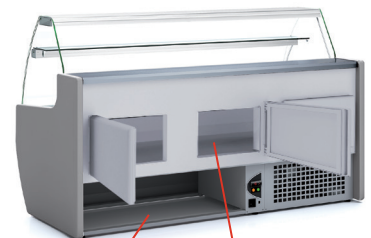

opcional

interior 440x270

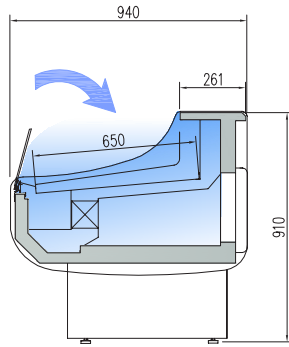

CVEA-9-10-TF	1.813 €
CVEA-9-13-TF	1.989 €
CVEA-9-15-TF	2.170 €
CVEA-9-20-TF	2.657 €
CVEA-9-25-TF	3.114 €
CVEA-9-30-TF	3.803 €

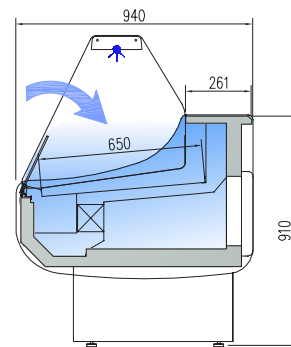

CVEE-9-10-TF	1.917 €
CVEE-9-13-TF	2.114 €
CVEE-9-15-TF	2.316 €
CVEE-9-20-TF	2.818 €
CVEE-9-25-TF	3.311 €
CVEE-9-30-TF	4.046 €

mod.	largo length (mm)	cámara storage (m³)	exposición display (m²)	puertas doors (uds)	potencia frig. frig. power (W)	consumo consumption (W)	refrigerante refrigerant
CVEA-9-10	1055	0,33	0,65	1	410	863	R-452A
CVEA-9-13	1305	0,43	0,82	2	550	987	R-452A
CVEA-9-15	1525	0,49	0,97	2	675	1102	R-452A
CVEA-9-20	2025	0,67	1,31	3	880	1277	R-452A
CVEA-9-25	2525	0,84	1,65	4	1050	1303	R-452A
CVEA-9-30	2995	1,19	1,96	4	1480	1592	R-452A
CVEE-9-10	1055	0,33	0,65	1	410	863	R-452A
CVEE-9-13	1305	0,43	0,82	2	550	987	R-452A
CVEE-9-15	1525	0,49	0,97	2	675	1102	R-452A
CVEE-9-20	2025	0,67	1,31	3	880	1277	R-452A
CVEE-9-25	2525	0,84	1,65	4	1050	1303	R-452A
CVEE-9-30	2995	1,19	1,96	4	1480	1592	R-404-A

características técnicas y constructivas sujetas a variación sin previo aviso

we reserve the right to change specifications whitout prior notice

- Exterior e interior en chapa de acero plastificada
 - Plano exposición y encimera en acero inox AISI-304
 - Bandejas plano de exposición lisas, con escalón al mismo precio
 - Costados de 40 mm en ABS inyectado excepto acabado madera
 - **Decoración estándar:** costados cortos gris oscuro frontal gris + franja decorativa azul. Perfilería en aluminio anodizado
 - Paragolpes en la parte delantera
 - Cristal frontal auto-servicio
 - **CVEE:** Iluminación LED 6500 K estándar: encimera superior y estante. Opción LED 3000 K (luz cálida) o ROSA, al mismo precio
 - Aislamiento de poliuretano inyectado, densidad 40 Kg/m³, cero efectos ODP y GWP
 - **Evaporador ventilado**, con tratamiento EPOXY anti-corrosión de serie
 - Condensación ventilada, evaporación automática de serie (sólo con motor incorporado)
 - Control electrónico de temperatura
 - Indicador de temperatura
 - Descarche automático
 - Clase climática 3 (25°C 60%) régimen M1
- M1 temperatura producto -1/+5°C UNE-EN ISO 23953-2:2006

- Interior and exterior finish in plastic coated steel
 - Display area and counter in stainless steel AISI-304
 - Smooth deck for display area, stepped at same price
 - 40 mm sides in injected ABS, exceptd wood decor
 - **Standard decoration:** short dark gray sides gray front+ blue decorative stripe
 - Anodised aluminium profiles
 - Front rubber bumper
 - Self-service frontal glass
 - **CVEE:** Standard LED 6500 K lighting: top worktop and shelf
 - Optional 3000 K LED (soft light) or Fresh red, same price
 - 40 Kg/m³ density polyurethane insulation, zero ODP and GWP
 - **Ventilated evaporator**, with anticorrosion EPOXY treated as standard
 - Ventilated condensation and automatic evaporation as standard (only models with condenser unit)
 - Electronic temperature controller
 - External thermometer
 - Auto defrost
 - Climate class 3 (25°C 60%) regime M1
- M1 product temperature -1/+5°C UNE-EN ISO 23953-2:2006

OPCIONES OPTIONS	decoración frontal front decor	decoración total total decor	lacado alto brillo High glossy lacquered	CVEE cierre plexi plexi door	cierre cortina night blind	CVEE luz extra LED extra lighting	neutra neutral	remoto remote
CVE-10	52 €	269 €	429 €	93 €	83 €	41 € x ud	-406 €	-122 €
CVE-13	57 €	274 €	440 €	124 €	109 €	54 € x ud	-456 €	-137 €
CVE-15	62 €	280 €	450 €	139 €	124 €	62 € x ud	-508 €	-147 €
CVE-20	67 €	285 €	461 €	186 €	166 €	83 € x ud	-609 €	-177 €
CVE-25	72 €	290 €	471 €	232 €	207 €	103 € x ud	-863 €	-203 €
CVE-30	77 €	295 €	482 €	280 €	248 €	124 € x ud	-985 €	-253 €

Versión REMOTO, incluye válvula de expansión (404a) y valvula solenoide
REMOTE version, expansion valve (404A) and solenoid valve, included

220v 60Hz / 115v 60Hz consultar - consult

Vitrina expositora modular serie 9 PASTELERÍA con reserva
 Serve over counter modular line 9 PASTRY with cold storage

7

all photos must be considered as a reference - fotografías no contractuales



DE SERIE
 STANDAR



CVEP-9-20-C
 lacado
 lacquered



CVEP-9-20-CC
 madera
 wood



decoración frontal
 front decor



versión RR

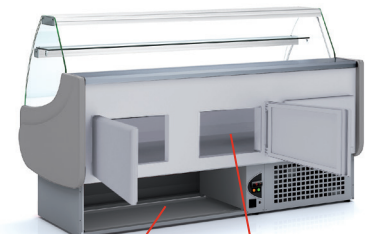

opcional interior 440x270

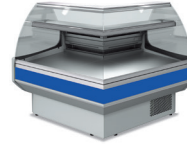
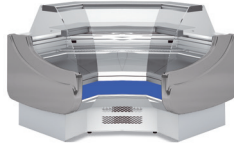
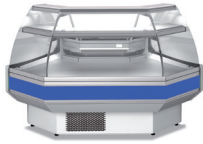

CVEP-9-AP90-C	4.735 €
CVEP-9-AP90-RR	4.735 €

CVEP-9-AN90-C	4.746 €
CVEP-9-AN90-RR	4.746 €

CVEP-9-RP90-C	4.735 €
CVEP-9-RP90-RR	4.735 €

CVEP-9-RN90-C	4.746 €
CVEP-9-RN90-RR	4.746 €

mod.	largo length (mm)	alto height (mm)	fondo depth (mm)	exposición display (m ²)	potencia frig. frig. power (W)	consumo consumption (W)	refrigerante refrigerant
CVEP-9-AN90	1500	1300	1500	0,98	687	1125	R-452A
CVEP-9-AP90	1325	1300	1325	1,04	687	1125	R-452A
CVEP-9N-AN45	1090	1300	1060	0,48	-	-	-
CVEP-9N-AP45	1040	1300	940	0,53	-	-	-
CVEP-9-RN90	1352	1300	1352	1,01	687	1125	R-452A
CVEP-9-RP90	1335	1300	1335	1,32	687	1125	R-452A
CMCVE-9-8	800	910	940	-	-	-	-
CMCVE-9-12	1200	910	940	-	-	-	-
CMCVE-9-AP90	1670	910	690	-	-	-	-
CMCVE-9-AN90	1638	910	825	-	-	-	-

OPCIONES OPTIONS	decoracion frontal front decor	decoracion total total decor	frontal alto brillo glossy frontal	total alto brillo total glossy	puerta plexi plexi door	cierre cortina night blind	luz extra LED extra lighting	neutra neutral	pre-instalacion remote unit
CVEP-9-AN90	62 €	280 €	176 €	450 €	186 €	166 €	62 €	-508 €	-147 €
CVEP-9-AP90	62 €	280 €	176 €	450 €	186 €	166 €	62 €	-508 €	-147 €
CVEP-9-RN90	62 €	280 €	176 €	450 €	186 €	166 €	62 €	-508 €	-147 €
CVEP-9-RP90	62 €	280 €	176 €	450 €	186 €	166 €	62 €	-508 €	-147 €
CVEP-9N-AN45	62 €	280 €	176 €	450 €	46 €	83 €	41 €	-	-
CVEP-9N-AP45	62 €	280 €	176 €	450 €	46 €	83 €	41 €	-	-
CMCVE-9-8	52 €	269 €	166 €	429 €	-	-	-	-	-
CMCVE-9-12	57 €	274 €	171 €	440 €	-	-	-	-	-
CMCVE-9-AP90	62 €	280 €	176 €	450 €	-	-	-	-	-
CMCVE-9-AN90	62 €	280 €	176 €	450 €	-	-	-	-	-

SERVE OVER COUNTER • VITRINAS MODULARES

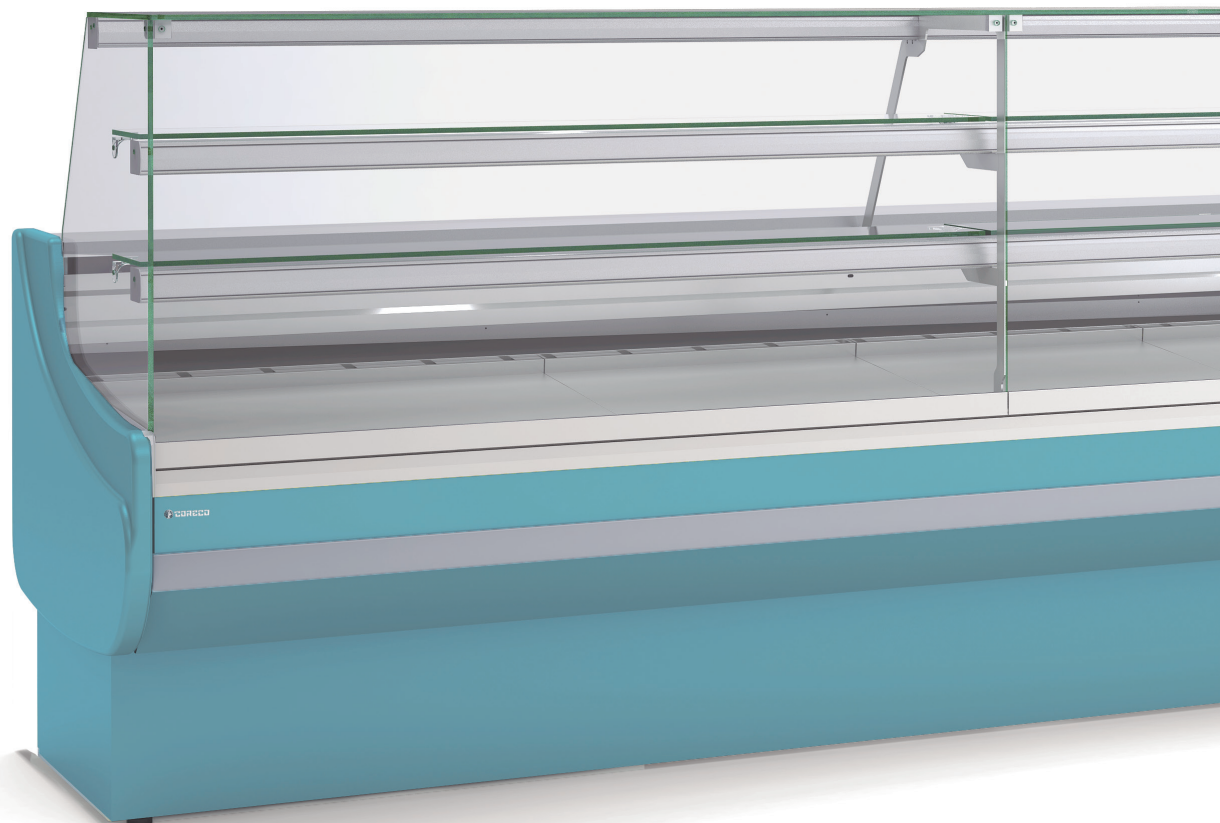

Vitrina expositora modular serie-9 PASTELERA, con reserva Serve over counters modular line-9 PASTRY, with and without cold storage

7

all photos must be considered as a reference - fotografías no contractuales

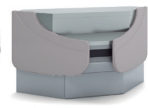
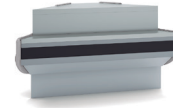
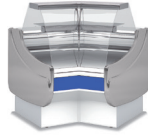

CVEP-9N-AP45-C	3.389 €
CVEP-9N-AP45-RR	3.389 €

CVEP-9N-AN45-C	3.415 €
CVEP-9N-AN45-RR	3.415 €

CMCVE-9-8	970 €
CMCVE-9-12	1.067 €

CMCVE-9-AP90	1.761 €
CMCVE-9-AN90	1.761 €

Cristales disponibles
Available glasses

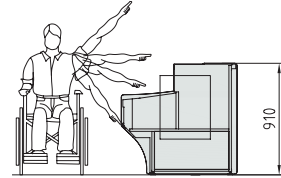
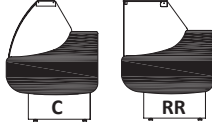

Altura adaptada
adapted height

características técnicas y constructivas sujetas a variación sin previo aviso

- Exterior e interior en chapa de acero plastificada
- Plano exposición y encimera en acero inox AISI-304
- Bandejas plano de exposición lisas, con escalón al mismo precio
- Costados de 40 mm en ABS inyectado excepto acabado madera
- Perfilera en aluminio anodizado
- Paragolpes en la parte delantera
- Cristal templado
- Aislamiento de poliuretano inyectado, densidad 40 Kg/m³, cero efectos ODP y GWP

AP90 / AN90 / RP90 / RN90

- Angulos refrigerados **sin reserva frigorífica**
- Compatibles con módulos CVEP-9
- **Evaporador ventilado**, con tratamiento EPOXY anti-corrosión de serie
- Condensación ventilada
- Control electrónico de temperatura
- Indicador de temperatura
- Descarche automático
- Evaporación automática de serie
- Clase climática 4 (30°C 55%) régimen M1 (-1/+5°C)

AP45 / AN45

- Angulos neutros
- Compatibles con módulos CVEP

CMCVE

- Mueble caja con cajón, estante y enchufe (excepto en ángulos)
- Todas las decoraciones al mismo precio

we reserve the right to change specifications whitout prior notice

- Interior and exterior finish in plastic coated steel
- Display area and counter in stainless steel AISI-304
- Smooth deck for display area, stepped at same price
- 40 mm sides in injected ABS, exceptd wood decor
- Anodised aluminium profiles
- Front rubber bumper
- Tempered glass
- 40 Kg/m³ density polyurethane insulation, zero ODP and GWP

AP90 / AN90 / RP90 / RN90

- Refrigerated angles, without cooling storage area
- Compatibles with CVEP-9 modules
- **Ventilated evaporator**, with anticorrosion EPOXY treated as standard
- Ventilated condensation
- Electronic temperature controller
- External thermometer
- Auto defrost
- Standard automatic evaporation
- Climate class 4 (30°C 55%) regime M1 (-1/+5°C)

AP45 / AN45

- Neutral angles
- Compatibles with CVEP modules

CMCVE

- Cash counters with shelve, drawer and plug (except angles)
- All decorations included in price

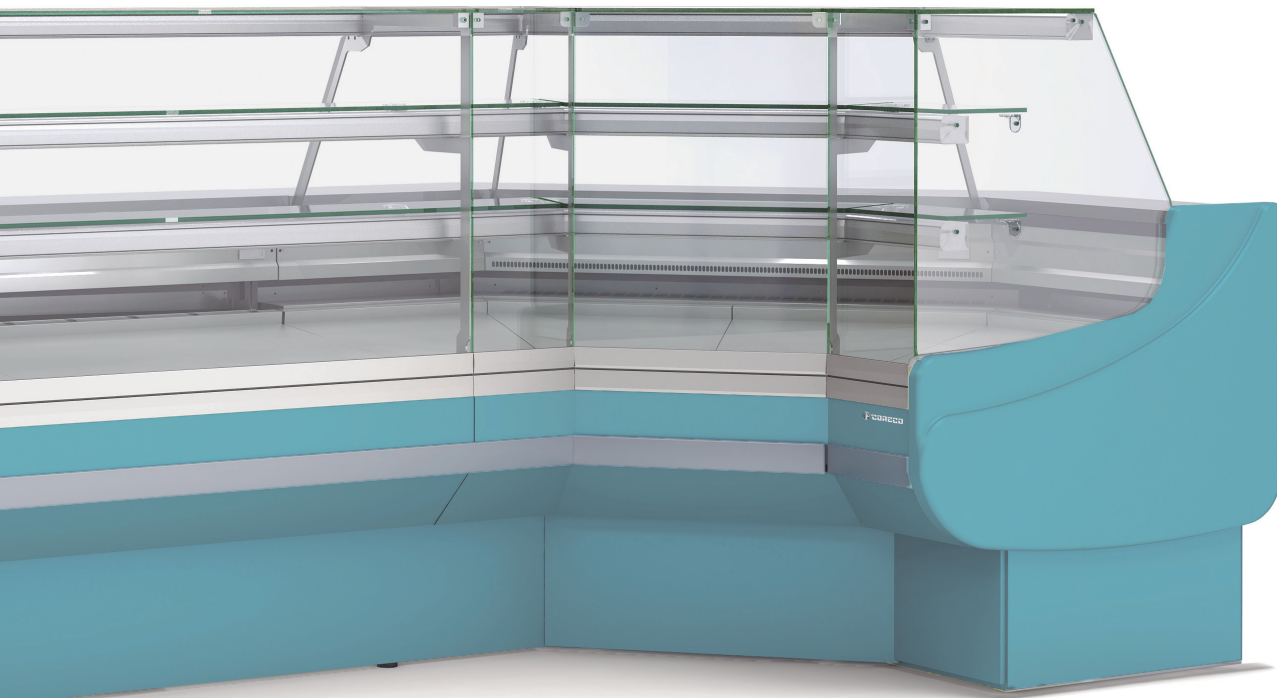

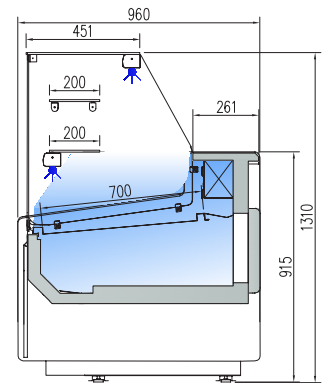
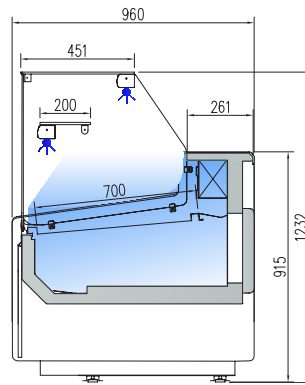
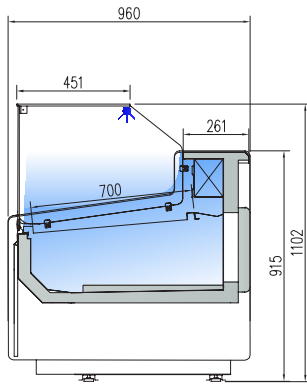

CON RESERVA - WITH COLD STORAGE

CVE-9-10-RCB	1.958 €
CVE-9-13-RCB	2.233 €
CVE-9-15-RCB	2.441 €
CVE-9-20-RCB	2.942 €
CVE-9-25-RCB	3.324 €
CVE-9-30-RCB	3.876 €

CVE-9-10-RC	2.063 €
CVE-9-13-RC	2.305 €
CVE-9-15-RC	2.518 €
CVE-9-20-RC	3.046 €
CVE-9-25-RC	3.469 €
CVE-9-30-RC	4.047 €

CVEP-9-10-RC	2.170 €
CVEP-9-13-RC	2.424 €
CVEP-9-15-RC	2.657 €
CVEP-9-20-RC	3.207 €
CVEP-9-25-RC	3.689 €
CVEP-9-30-RC	4.311 €

SIN RESERVA - WITHOUT COLD STORAGE

CVES-9-10-RCB	1.917 €
CVES-9-13-RCB	2.150 €
CVES-9-15-RCB	2.358 €
CVES-9-20-RCB	2.818 €
CVES-9-25-RCB	3.158 €
CVES-9-30-RCB	3.691 €

CVES-9-10-RC	2.022 €
CVES-9-13-RC	2.222 €
CVES-9-15-RC	2.435 €
CVES-9-20-RC	2.922 €
CVES-9-25-RC	3.304 €
CVES-9-30-RC	3.860 €

CVEPS-9-10-RC	2.129 €
CVEPS-9-13-RC	2.341 €
CVEPS-9-15-RC	2.574 €
CVEPS-9-20-RC	3.083 €
CVEPS-9-25-RC	3.523 €
CVEPS-9-30-RC	4.125 €

mod.	largo length (mm)	cámara storage CVE(m ³)	exposición display (m ²)	puertas doors (uds)	potencia frig. frig. power (W)	consumo consumption (W)	refrigerante refrigerant
CVE/CVES-9-10	1055	0,33	0,65	1	410	863	R-452A
CVE/CVES-9-13	1305	0,43	0,82	2	550	987	R-452A
CVE/CVES-9-15	1525	0,49	0,97	2	675	1102	R-452A
CVE/CVES-9-20	2025	0,67	1,31	3	880	1277	R-452A
CVE/CVES-9-25	2525	0,84	1,65	4	1050	1303	R-452A
CVE/CVES-9-30	2995	1,19	1,96	4	1480	1592	R-452A

características técnicas y constructivas sujetas a variación sin previo aviso

we reserve the right to change specifications whitout prior notice

- Exterior e interior en chapa de acero plastificada
- Plano exposición y encimera en acero inox AISI-304
- Bandejas plano de exposición lisas, con escalón al mismo precio
- Costados de 40 mm en ABS inyectado
- **Decoración estándar:** costados gris claro frontal inferior gris claro + franja superior inox. Perfilería en aluminio anodizado
- Paragolpes en la parte delantera
- Cristal frontal templado y abatible
- Estante de cristal intermedio, no refrigerado
- Iluminación LED 6500 K estándar: encimera superior y estante
- Opción LED 3000 K (luz cálida) o ROSA, al mismo precio
- Aislamiento de poliuretano inyectado, densidad 40 Kg/m³, cero efectos ODP y GWP
- Reserva refrigerada con puertas, hueco 440x270
- **Evaporador estático**, con tratamiento EPOXY anti-corrosión de serie
- Condensación ventilada, evaporación automática de serie (sólo con motor incorporado)
- Control electrónico de temperatura
- Indicador de temperatura
- Descarche automático
- Clase climática 4 (30°C 55%) régimen M1

M1 temperatura producto -1/+5°C UNE-EN ISO 23953-2:2006

- Interior and exterior finish in plastic coated steel
- Display area and counter in stainless steel AISI-304
- Smooth deck for display area, stepped at same price
- Sides in ABS injected, 40 mm thick
- **Standard decoration:** bottom frontal and sides in light grey, top frontal in stainless steel
- Anodised aluminium profiles
- Front rubber bumper
- Toughened and hinged frontal glass
- Glass shelf non refrigerated
- Standard LED 6500 K lighting: top worktop and shelf
- Optional 3000 K LED (soft light) or Fresh red, same price
- 40 Kg/m³ density polyurethane insulation, zero ODP and GWP
- Refrigerated under storage with doors 440x270
- **Static evaporator**, with anticorrosion EPOXY treated as standard
- Ventilated condensation and automatic evaporation as standard (only models with condenser unit)
- Electronic temperature controller
- External thermometer
- Auto defrost
- Climate class 4 (30°C 55%) regime M1

M1 product temperature -1/+5°C UNE-EN ISO 23953-2:2006

OPCIONES OPTIONS	decoración frontal front decor	decoración total total decor	lacado alto brillo High glossy lacquered	cierre plexi plexi doors	cierre cortina night blind	luz extra LED extra lighting	neutra neutral	remoto remote
CVE/CVES-10	52 €	269 €	429 €	93 €	83 €	41 € x ud	-406 €	-122 €
CVE/CVES-13	57 €	274 €	440 €	124 €	109 €	54 € x ud	-456 €	-137 €
CVE/CVES-15	62 €	280 €	450 €	139 €	124 €	62 € x ud	-508 €	-147 €
CVE/CVES-20	67 €	285 €	461 €	186 €	166 €	83 € x ud	-609 €	-177 €
CVE/CVES-25	72 €	290 €	471 €	232 €	207 €	103 € x ud	-863 €	-203 €
CVE/CVES-30	77 €	295 €	482 €	280 €	248 €	124 € x ud	-985 €	-253 €

Versión REMOTO, incluye válvula de expansión (404a) y valvula solenoide
REMOTE version, expansion valve (404A) and solenoid valve, included

220v 60Hz / 115v 60Hz consultar - consult

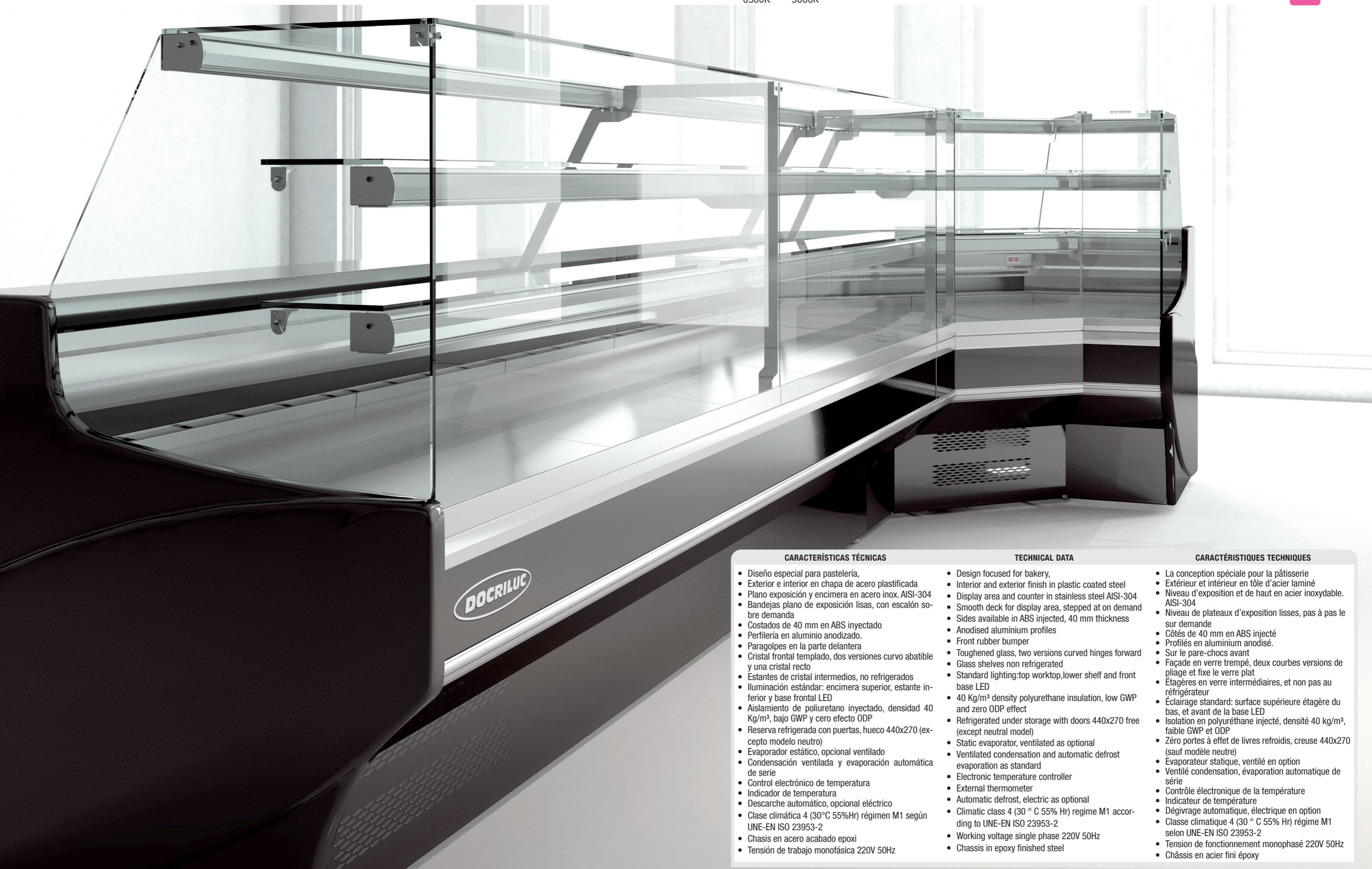

CARACTERÍSTICAS TÉCNICAS

- Diseño especial para pastelería.
- Exterior e interior en chapa de acero plastificada
- Plano exposición y encimera en acero inox. AISI-304
- Bandejas plano de exposición lisas, con escalón sobre demanda
- Costados de 40 mm en ABS inyectado
- Perfilera en aluminio anodizado.
- Paragolpes en la parte delantera
- Cristal frontal templado, dos versiones curvo abatible y una cristal recto
- Estantes de cristal intermedios, no refrigerados
- Iluminación estándar: encimera superior, estante inferior y base frontal LED
- Aislamiento de poliuretano inyectado, densidad 40 Kg/m³, bajo GWP y cero efecto ODP
- Reserva refrigerada con puertas, hueco 440x270 (excepto modelo neutro)
- Evaporador estático, opcional ventilado
- Condensación ventilada y evaporación automática de serie
- Control electrónico de temperatura
- Indicador de temperatura
- Descarche automático, opcional eléctrico
- Clase climática 4 (30°C 55% Hr) régimen M1 según UNE-EN ISO 23953-2
- Chasis en acero acabado epoxi
- Tensión de trabajo monofásica 220V 50Hz

TECHNICAL DATA

- Design focused for bakery.
- Interior and exterior finish in plastic coated steel
- Display area and counter in stainless steel AISI-304
- Smooth deck for display area, stepped at on demand
- Sides available in ABS injected, 40 mm thickness
- Anodised aluminium profiles
- Front rubber bumper
- Toughened glass, two versions curved hinges forward
- Glass shelves non refrigerated
- Standard lighting: top worktop, lower shelf and front base LED
- 40 Kg/m³ density polyurethane insulation, low GWP and zero ODP effect
- Refrigerated under storage with doors 440x270 free (except neutral model)
- Static evaporator, ventilated as optional
- Ventilated condensation and automatic defrost evaporation as standard
- Electronic temperature controller
- External thermometer
- Automatic defrost, electric as optional
- Climatic class 4 (30 ° C 55% Hr) regime M1 according to UNE-EN ISO 23953-2
- Working voltage single phase 220V 50Hz
- Chassis in epoxy finished steel

CARACTÉRISTIQUES TECHNIQUES

- La conception spéciale pour la pâtisserie
- Extérieur et intérieur en tôle d'acier laminé
- Niveau d'exposition et de haut en acier inoxydable. AISI-304
- Niveau de plateaux d'exposition lisses, pas à pas le sur demande
- Côtés de 40 mm en ABS injecté
- Profilés en aluminium anodisé.
- Sur le pare-chocs avant
- Façade en verre trempé, deux courbes versions de pliage et fixe le verre plat
- Étagères en verre intermédiaires, et non pas au réfrigérateur
- Éclairage standard: surface supérieure étagère du bas, et avant de la base LED
- Isolation en polyuréthane injecté, densité 40 kg/m³, faible GWP et ODP
- Zéro portes à effet de livres refroidis, creuse 440x270 (sauf modèle neutre)
- Evaporateur statique, ventilé en option
- Ventilé condensation, évaporation automatique de série
- Contrôle électronique de la température
- Indicateur de température
- Dégivrage automatique, électrique en option
- Classe climatique 4 (30 ° C 55% Hr) régime M1 selon UNE-EN ISO 23953-2
- Tension de fonctionnement monophasé 220V 50Hz
- Châssis en acier fini époxy

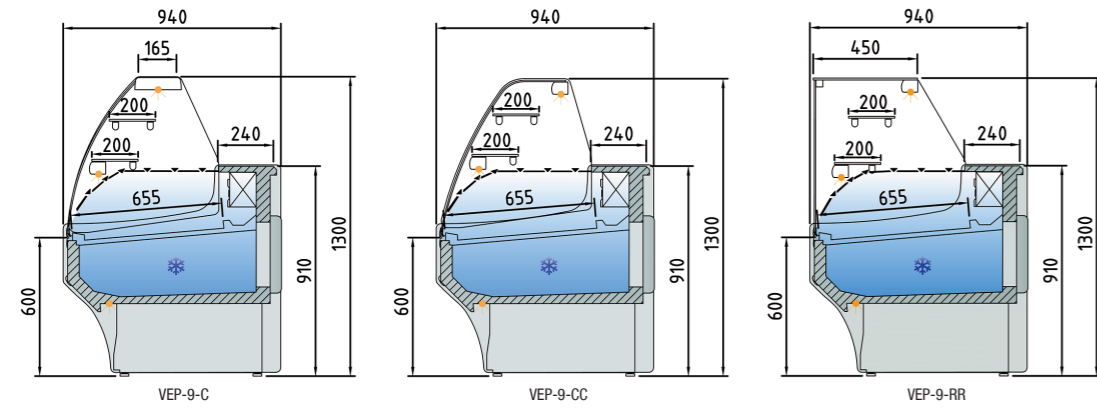

VEP-9-20-C



Decoración personalizada, consultar
Customized decoration, consult
Décoration personnalisée, consulter

Opción guías pasteleras solo modelo estático
Pastry guides option only whirh static models
Guides de modèle unique statiques option de pâtisserie

Estante de cristal no refrigerado
Glass shelf non refrigerated
Étagère en verre non refroidi

Ver características técnicas en página 39 / See technical data in page 39 / Voir caractéristiques techniques page 39

Modelo Model Modèle	Largo Length Longueur (mm)	Cámara VE Storage VE Stockage VE (m ²)	Exposición Display Exposition (m ²)	Puertas VE / VES Doors VE / VES Portes VE / VES (Uds)	Potencia frig. Frig. Power Puissance frig. (W)	Consumo Consumption Consommation (W)	Refrigerante Coolant Réfrigérant
VEP-9-10	1055	0,33	0,65	1/0	522	404	R-452A
VEP-9-13	1305	0,43	0,82	2/0	635	1009	R-452A
VEP-9-15	1525	0,49	0,97	2/0	817	1079	R-452A
VEP-9-20	2025	0,67	1,31	3/0	817	1103	R-452A
VEP-9-25	2525	0,84	1,65	4/0	1096	1365	R-452A
VEP-9-30	2995	1,19	1,96	4/0	1315	1416	R-452A

230v 60Hz / 115v 60Hz, consultar - consult - consulter



VEP-9-30-RR
TOTAL LACADO · LACQUERED TOTAL · TOTAL LAQUÉ

Modelo Model Modèle	OPCIONES · OPTIONS · OPTIONS								
	1 decoración frontal / front decor / décoration frontal	2 Total decoración / Total decor / décoration total	Cierre Plexi Plexi slide Kit vitrage plexi	Cierre cortina Night blind Rideau nocturne	Iluminación led extra Extra led lighting Éclairage Led extra	Neutra Neutral Neutre	Pre Instalación Remote Unit Groupé à distance	Ventilada Ventilated Ventilé	Juego guías pasteleras Guides pastry kit Guides kit pâtisserie
VEP-9-10	55 €	270 €	92 €	82 €	41 €	-410 €	-123 €	123 €	92 €
VEP-9-13	60 €	275 €	123 €	108 €	53 €	-461 €	-138 €	143 €	92 €
VEP-9-15	65 €	280 €	138 €	123 €	61 €	-513 €	-148 €	174 €	92 €
VEP-9-20	70 €	285 €	184 €	164 €	82 €	-615 €	-179 €	205 €	92 €
VEP-9-25	75 €	290 €	230 €	205 €	102 €	-872 €	-205 €	241 €	92 €
VEP-9-30	80 €	295 €	277 €	246 €	123 €	-995 €	-256 €	343 €	92 €

Características técnicas y constructivas sujetas a variación sin previo aviso. / We reserve the right to change specifications without prior notice. / Sujet technique et la conception de modifications sans préavis.

VEP-9-10-RR 2.128 €	VEP-9-13-RR 2.349 €	VEP-9-15-RR 2.565 €	VEP-9-20-RR 3.103 €	VEP-9-25-RR 3.621 €	VEP-9-30-RR 4.339 €
VEP-9-10-C 2.128 €	VEP-9-13-C 2.349 €	VEP-9-15-C 2.565 €	VEP-9-20-C 3.103 €	VEP-9-25-C 3.621 €	VEP-9-30-C 4.339 €
VEP-9-10-CC 2.175 €	VEP-9-13-CC 2.400 €	VEP-9-15-CC 2.616 €	VEP-9-20-CC 3.124 €	VEP-9-25-CC 3.693 €	VEP-9-30-CC 4.427 €



6500K

3000K

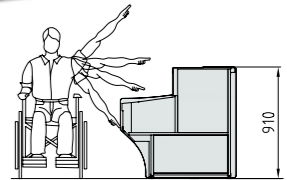
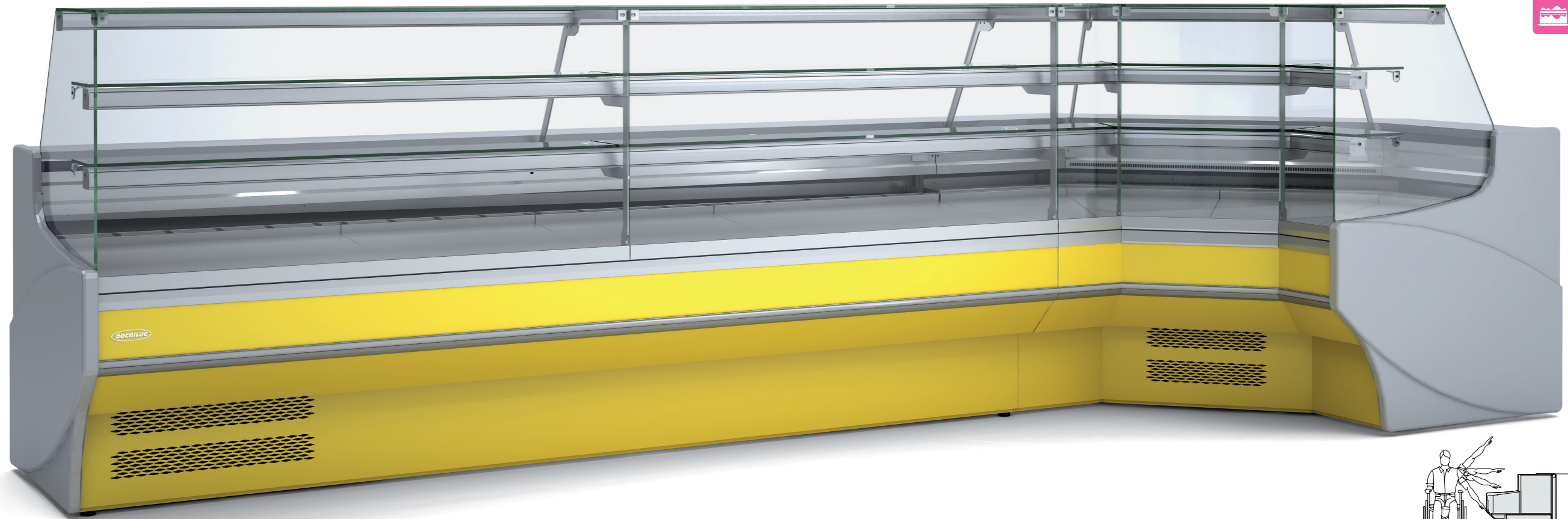

Servicio adaptado
 Service adapted
 Service adaptés

Ver características técnicas en página 39 / See technical data in page 39 / Voir caractéristiques techniques page 39

CARACTERÍSTICAS TÉCNICAS ÁNGULOS REFRIGERADOS

- Sistema de evaporación ventilado
- Modelos AP45 y AN45 neutros
- **C:** Cristal curvo
- **RR:** Cristal doble recto
- Mismo precio para cristales **C** y **RR**
- Todos los modelos sin puerta de reserva

REFRIGERATED ANGLE TECHNICAL DATA

- Ventilated evaporation system
- Neutral models AP45 y AN45
- **C:** Curved glass
- **RR:** Double flat glass
- Same price for crystals **C** and **RR**
- All door models without reservation

CARACTÉRISTIQUES TECHNIQUES DES ANGLES RÉFRIGÉRÉS

- Système d'évaporation ventilé
- Modèles AP45 y AN45 neutros
- **C:** Vitre bombée
- **RR:** Vitre double droit
- Même prix pour le verre **C** et **RR**
- Tous les modèles sans portes de réserve

CARACTERÍSTICAS TÉCNICAS MUEBLES CAJAS

- Todos los modelos con cajón incorporado, estantes y enchufe excepto MCVE-9-AP90
- Decoración incluida

CASH NEUTRAL COUNTER DATA

- All models include drawer, shelves and plug except MCVE-9-AP90
- Decoration included

CARACTÉRISTIQUES TECHNIQUES DES MEUBLE CAISSE

- Tous les modèles avec tiroir incorporé, étagères et prise électrique sant MCVE-9-AP90
- Décoration inclus

**DETALLE
 DETAIL / DETAIL**



**MUEBLES CAJA NEUTROS EN ÁNGULO
 ANGULAR NEUTRAL CASH COUNTER / MEUBLE CAISSE NEUTRE ANGULAIRE**

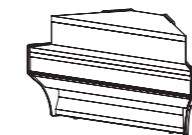

MCVE-9-AP90 **1.744 €**

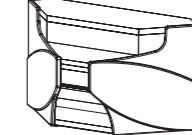

MCVE-9-AN90 **1.744 €**

**MUEBLES CAJA NEUTROS
 CASH NEUTRAL COUNTER / MEUBLE CAISSE NEUTRE**

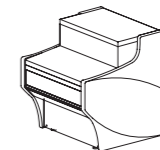

MCVE-9-8 **960 €**

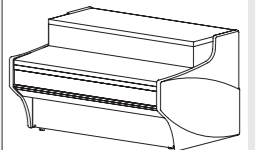

MCVE-9-12 **1.056 €**

ÁNGULOS NEGATIVOS / NEGATIVE ANGLES / NÉGATIF ANGLES



VEP-9-RN90 **4.699 €** VEP-9-AN90 **4.699 €** VEP-9N-AN45 **3.385 €**

ÁNGULOS POSITIVOS / POSITIVE ANGLES / POSITIF ANGLES



VEP-9-RP90 **4.688 €** VEP-9-AP90 **4.688 €** VEP-9N-AP45 **3.355 €**

230v 60Hz / 115v 60Hz. consultar - consult - consulter

OPCIONES · OPTIONS · OPTIONS

Modelo	1 decoración frontal / front decor / décoration frontal	2 Total decoración / Total decor / décoration total	Cierre Plexi Plexi slide Kit vitrage plexi	Iluminación led extra Extra led lighting Éclairage Led extra	Cierre cortina Night blind Rideau nocturne	Neutra Neutral Neutre	Pre Instalación Remote Unit Groupe à distance
VEP-9-AP90	65 €	280 €	184 €	61 €	164 €	-513 €	-148 €
VEP-9-RP90	65 €	280 €	184 €	61 €	164 €	-513 €	-148 €
VEP-9-AN90	65 €	280 €	184 €	61 €	164 €	-513 €	-148 €
VEP-9-RN90	65 €	280 €	184 €	61 €	164 €	-513 €	-148 €
VEP-9-AP45	65 €	280 €	46 €	41 €	82 €	-	-
VEP-9-AN45	65 €	280 €	46 €	41 €	82 €	-	-

Características técnicas y constructivas sujetas a variación sin previo aviso / We reserve the right to change specifications without prior notice / Sujet technique et la conception de modifications sans préavis

Modelo Model Modèle	Largo Length Longueur (mm)	Alto Height Hauteur (mm)	Fondo Depth Profondeur (mm)	Cámara Storage Stockage (m³)	Exposición Display Exposition (m²)	Puertas Doors Portes (Uds)	Potencia frig. Frig. Power Puissance frig. (W)	Consumo Consumption Consommation (W)	Refrigerante Coolant Réfrigérant
VEP-9-AN90	1500	1230	1500	-	0,98	0	817	1122	R-452A
VEP-9-AP90	1325	1230	1325	-	1,04	0	817	1165	R-452A
VEP-9N-AN45	1090	1230	1060	-	0,48	0		3	
VEP-9N-AP45	1040	1230	940	-	0,53	0		3	
VEP-9-RN90	1352	1230	1352	-	1,01	0	635	961	R-452A
VEP-9-RP90	1335	1230	1335	-	1,32	0	635	1004	R-452A
MCVE-9-8	800	910	940						
MCVE-9-12	1200	910	940						
MCVE-9-AP90	1670	910	690						
MCVE-9-AN90	1638	910	825						



CARACTERÍSTICAS TÉCNICAS

- Diseño especial para pastelería
- Exterior e interior en chapa de acero plastificada
- Plano exposición y encimera en acero inox. AISI-304
- Bandejas plano de exposición lisas, con escalón sobre demanda
- Costados de 40 mm en ABS inyectado o lacado
- Perfilera en aluminio anodizado.
- Paragolpes en la parte delantera
- Cristal frontal templado, tres versiones
- Estantes de cristal intermedios, no refrigerados
- Iluminación estándar: encimera superior, estante inferior y base frontal LED
- Aislamiento de poliuretano inyectado, densidad 40 Kg/m³, bajo GWP y cero efecto ODP
- Evaporador estático
- Reserva refrigerada con puertas, hueco 440x270 (excepto modelo neutro)
- Condensación ventilada, evaporación automática de serie
- Control electrónico de temperatura
- Indicador de temperatura
- Descarga automática, opcional eléctrico
- Clase climática 4 (30°C 55% Hr) régimen M1 según UNE-EN ISO 23953-2
- Chasis en acero acabado epoxi
- Tensión de trabajo monofásica 220V 50Hz
- **VP-9:** Cristal alto pastelero
- **VP-9B:** Cristal bajo

TECHNICAL DATA

- Design focused for bakery
- Interior and exterior finish in plastic coated steel
- Display area and counter in stainless steel AISI-304
- Smooth deck for display area, stepped at on demand
- Sides in ABS injected or lacquered, 40 mm thick
- Anodised aluminium profiles
- Front rubber bumper
- Toughened glass, three versions
- Glass shelves non refrigerated
- Standard lighting: top worktop, lower shelf and front base LED
- 40 Kg/m³ density polyurethane insulation, low GWP and zero ODP effect
- Static evaporator
- Refrigerated under storage with doors 440x270 free (except neutral model)
- Ventilated condensation and automatic defrost evaporation as standard
- Electronic temperature controller
- External thermometer
- Automatic defrost, electric as optional
- Climatic class 4 (30 ° C 55% Hr) regime M1 according to UNE-EN ISO 23953-2
- Working voltage single phase 220V 50Hz
- Chassis in epoxy finished steel
- **VP-9:** Tall glass pastry
- **VP-9B:** Under glass

CARACTÉRISTIQUES TECHNIQUES

- La conception spéciale pour la pâtisserie
- Extérieur et intérieur en tôle d'acier laminé
- Niveau d'exposition et de haut en acier inoxydable AISI-304
- Niveau de plateaux d'exposition lisses, pas à pas le sur demande
- Côtés de 40 mm ABS injecté ou laquées
- Profilés en aluminium anodisé.
- Sur le pare-chocs avant
- Façade en verre trempé, trois courbes
- Étagères en verre intermédiaires, et non pas au réfrigérateur LED
- Isolation en polyuréthane injecté, densité 40 kg/m³, faible GWP et ODP nul effet
- Support tablette dans la zone de service
- Évaporateur statique
- Zéro portes à effet de livres refroidis, creuse 440x270 (sauf modèle neutre)
- Ventilé série évaporation de la condensation, automatique
- Contrôle électronique de la température
- Indicateur de température
- Dégivrage automatique, électrique en option
- Classe climatique 4 (30 ° C 55% Hr) régime M1 selon UNE-EN ISO 23953-2
- Tension de fonctionnement monophasé 220V 50Hz
- Châssis en acier fini époxy
- **VP-9:** Grand pâte de verre
- **VP-9B:** Sous verre



6500K



3000K

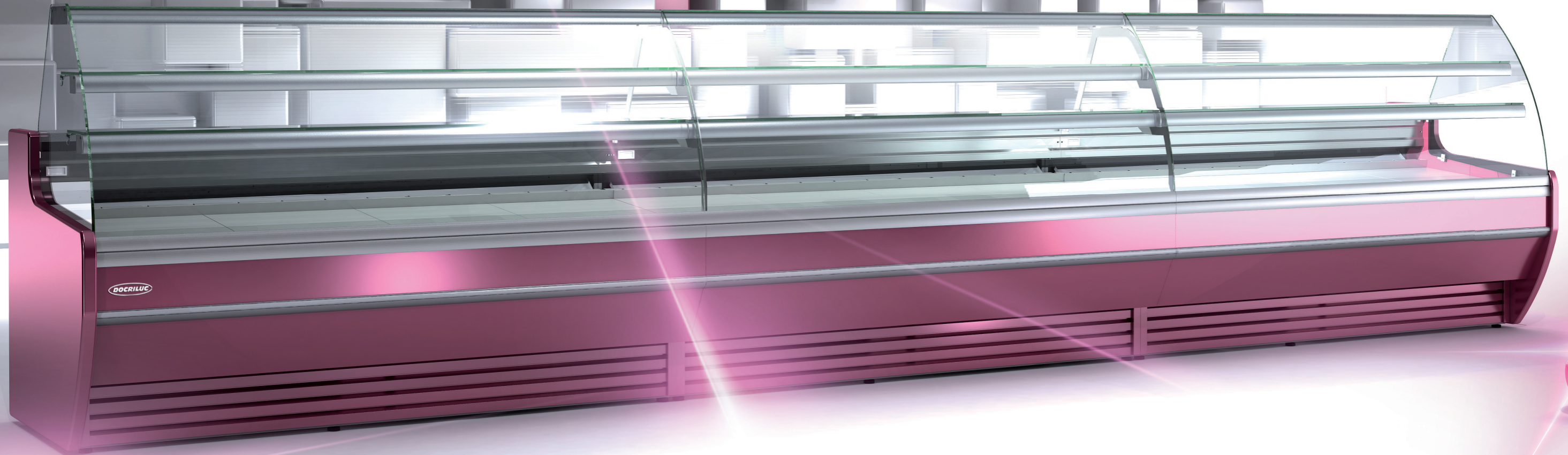

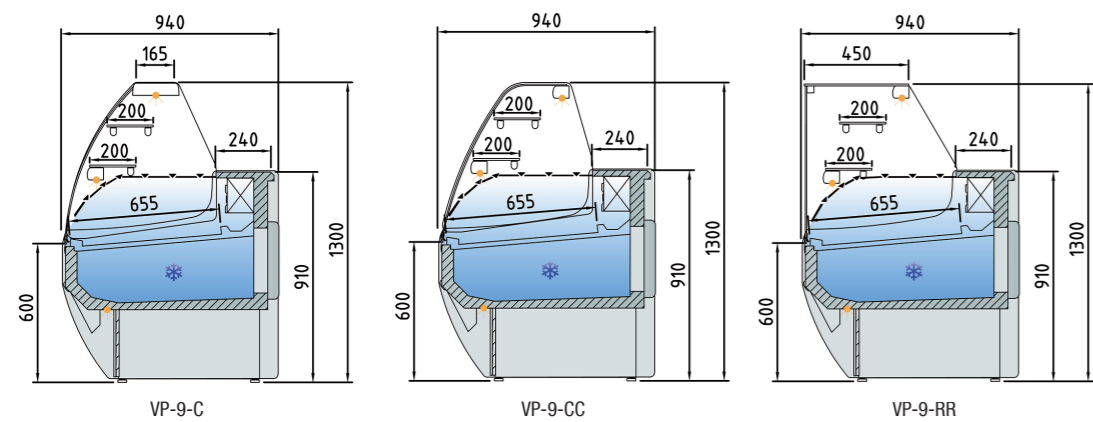
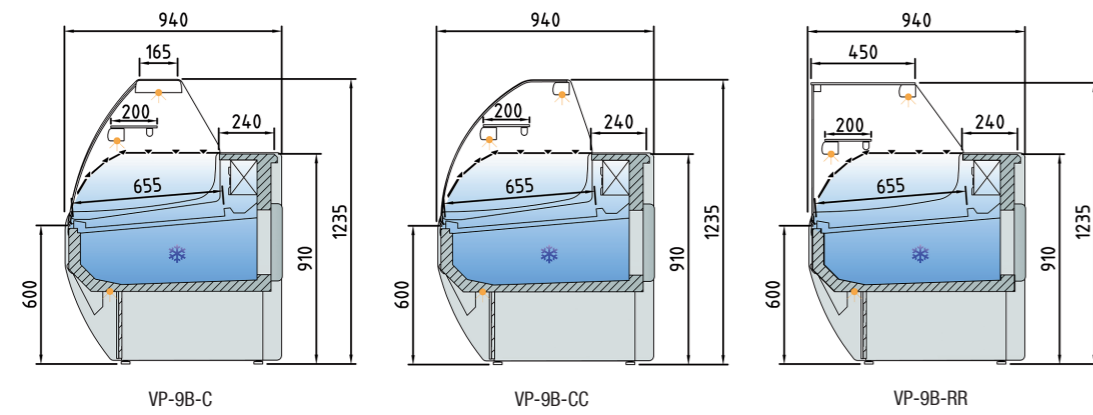

Detalle iluminación frente bajo
Detailed low front lighting detail
Détailé éclairage basse avant

Ver características técnicas en página 44 / See technical data in page 44 / Voir caractéristiques techniques page 44

Modelo Model Modèle	Largo Length Longueur (mm)	Cámara VE Storage VE Stockage VE (m ²)	Exposición Display Exposition (m ²)	Puertas Doors Portes (Uds)	Potencia frig. Frig. Power Puissance frig. (W)	Consumo Consumption Consommation (W)	Refrigerante Coolant Réfrigérant
VP / VPB-9-10	1055	0,33	0,65	1	522	404	R-452A
VP / VPB-9-13	1305	0,43	0,82	2	635	1009	R-452A
VP / VPB-9-15	1525	0,49	0,97	2	817	1079	R-452A
VP / VPB-9-20	2025	0,67	1,31	3	817	1103	R-452A
VP / VPB-9-25	2525	0,84	1,65	4	1096	1365	R-452A
VP / VPB-9-30	2995	1,19	1,96	4	1315	1416	R-452A

230v 60Hz / 115v 60Hz. consultar - consult - consulter

OPCIONES - OPTIONS - OPTIONS

Modelo Model Modèle	1 decoración frontal / front decor / décoration frontal		2 Total decoración / Total decor / décoration total		Cierre Plexi Plexi slide Kit vitrage plexi	Cierre cortina Night blind Rideau nocturne	Iluminación led extra Extra led lighting Éclairage Led extra	Neutra Neutral Neutre	Pre Instalación Remote Unit Groupe à distance	Ventilada Ventilated Ventilé	Juego guías pasteleras Guides pastry kit Guides kit pâtisserie
VEP-9-10	55 €		270 €		92 €	82 €	41 €	-410 €	-123 €	123 €	92 €
VEP-9-13	60 €		275 €		123 €	108 €	53 €	-461 €	-138 €	143 €	92 €
VEP-9-15	65 €		280 €		138 €	123 €	61 €	-513 €	-148 €	174 €	92 €
VEP-9-20	70 €		285 €		184 €	164 €	82 €	-615 €	-179 €	205 €	92 €
VEP-9-25	75 €		290 €		230 €	205 €	102 €	-872 €	-205 €	241 €	92 €
VEP-9-30	80 €		295 €		277 €	246 €	123 €	-995 €	-256 €	343 €	92 €

Características técnicas y constructivas sujetas a variación sin previo aviso. / We reserve the right to change specifications without prior notice. / Sujet technique et la conception de modifications sans préavis.

VITRINA EXPOSITORA PASTELERA VP-9 / VP-9B

SERVE OVER COUNTER PASTRY LINE VP-9 / VP9B · VITRINE SERIE VP-9 / VP-9B GAMME PÂTISSERIE



VP-9-20-CC
TOTAL LACADO / LACQUERED TOTAL / TOTAL LAQUÉ



VP-9B-20-C
TOTAL LACADO / LACQUERED TOTAL / TOTAL LAQUÉ

VP-9-10-RR 2.305 €	VP-9-13-RR 2.534 €	VP-9-15-RR 2.756 €	VP-9-20-RR 3.338 €	VP-9-25-RR 3.904 €	VP-9-30-RR 4.671 €
VP-9B-10-RR 2.115 €	VP-9B-13-RR 2.321 €	VP-9B-15-RR 2.528 €	VP-9B-20-RR 3.061 €	VP-9B-25-RR 3.578 €	VP-9B-30-RR 4.284 €
VP-9-10-C 2.305 €	VP-9-13-C 2.534 €	VP-9-15-C 2.756 €	VP-9-20-C 3.338 €	VP-9-25-C 3.904 €	VP-9-30-C 4.671 €
VP-9B-10-C 2.115 €	VP-9B-13-C 2.321 €	VP-9B-15-C 2.528 €	VP-9B-20-C 3.061 €	VP-9B-25-C 3.578 €	VP-9B-30-C 4.284 €
VP-9-10-CC 2.354 €	VP-9-13-CC 2.577 €	VP-9-15-CC 2.816 €	VP-9-20-CC 3.409 €	VP-9-25-CC 3.975 €	VP-9-30-CC 5.047 €
VP-9B-10-CC 2.158 €	VP-9B-13-CC 2.365 €	VP-9B-15-CC 2.582 €	VP-9B-20-CC 3.126 €	VP-9B-25-CC 3.648 €	VP-9B-30-CC 4.371 €

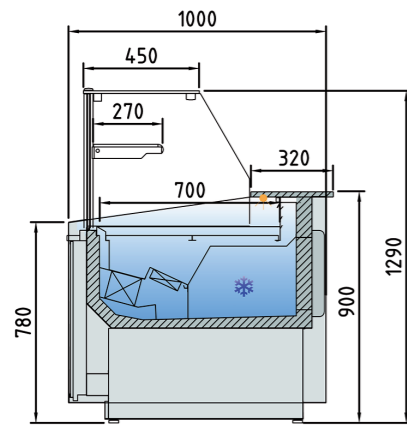

VEGPC-10

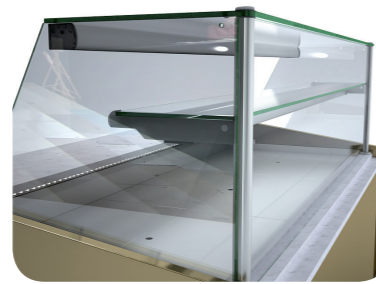

Detalle columna exterior
External column detail
Detail colonne extérieure



Detalle columna interior
Inside column detail
Detail colonne intérieur



VEGPC-10-20

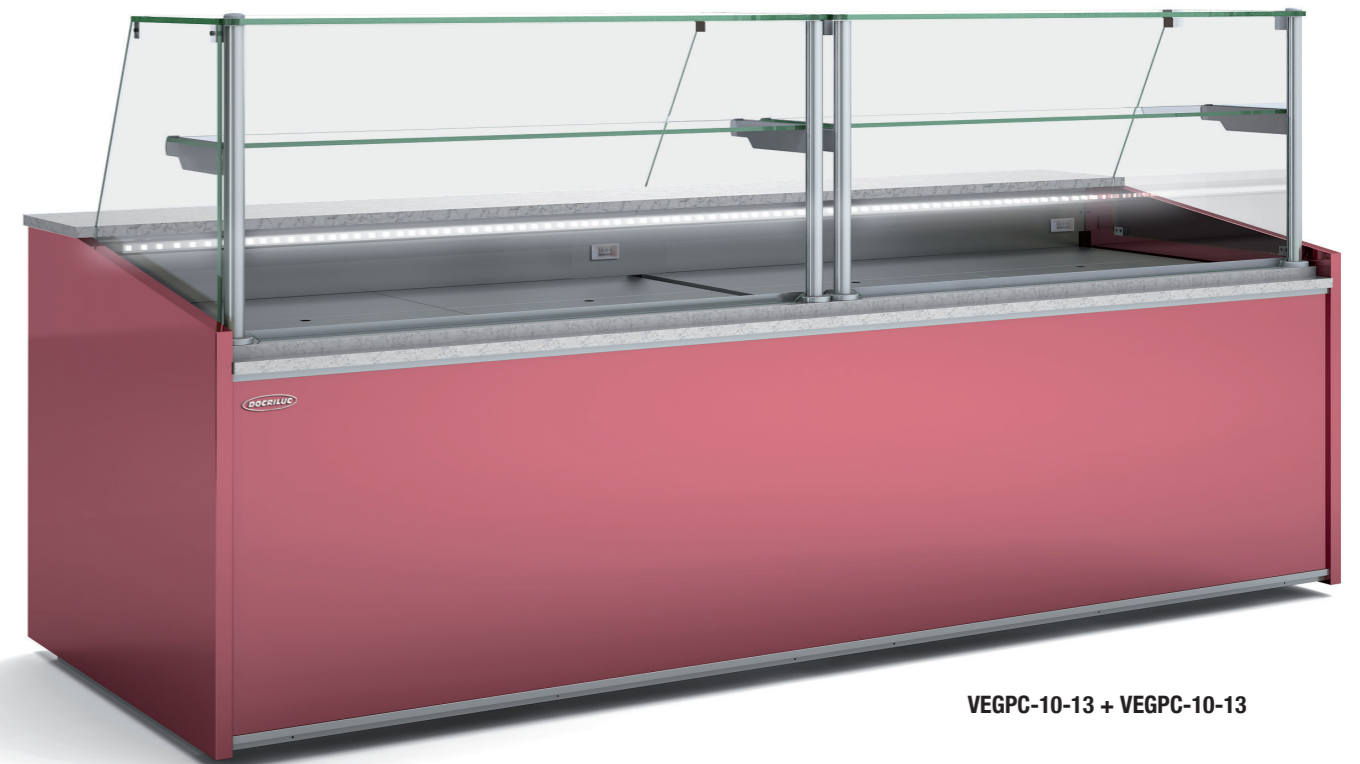

VEGPC-10-13 + VEGPC-10-13

Ver características técnicas en página 74 / See technical data in page 74 / Voir caractéristiques techniques page 74

Modelo Model Modèle	Largo Length Longueur (mm)	Cámara Storage Stockage (m³)	Exposición Display Exposition (m²)	Puertas Doors Portes (Uds) (Units)	Potencia frig. Frig. Power Puissance frig. (W)	Consumo Consumption Consommation (W)	Refrigerante Coolant Réfrigérant
VEGPC-10-10-TF	1035	0,38	0,61	1	522	383	R-452A
VEGPC-10-13-TF	1285	0,5	0,8	2	635	990	R-452A
VEGPC-10-15-TF	1505	0,58	0,93	2	817	1053	R-452A
VEGPC-10-20-TF	2005	0,79	1,24	3	1096	1305	R-452A

230v 60Hz / 115v 60Hz. consultar - consult - consulter

OPCIONES · OPTIONS · OPTIONS

Modelo Model Modèle	Neutra Neutral Neutre	Pre Instalación Remote Unit Groupe à distance	Puertas Cierre Plexi Plexi slide Doors Kit vitrage arrière coulissant plexi
VEG-10-10-TF	-410 €	-123 €	92 €
VEG-10-13-TF	-461 €	-138 €	123 €
VEG-10-15-TF	-513 €	-148 €	138 €
VEG-10-20-TF	-615 €	-179 €	184 €

Características técnicas y constructivas sujetas a variación sin previo aviso. / We reserve the right to change specifications without prior notice. / Sujet technique et la conception de modifications sans préavis.

VEGPC-10-10-TF 2.690 €	VEGPC-10-13-TF 2.995 €	VEGPC-10-15-TF 3.401 €	VEGPC-10-20-TF 3.850 €



Mueble caja torre MCT-70-VEG
 Cash neutral counter tower MCT-70-VEG
 Meuble caisse tour MCT-70-VEG

Ver características técnicas en página 74 / See technical data in page 74 / Voir caractéristiques techniques page 74

CARACTERÍSTICAS TÉCNICAS ÁNGULOS REFRIGERADOS

- Sistema de evaporación ventilado
- VEG vitrina con reserva
- Todos los modelos sin puerta de reserva

REFRIGERATED ANGLE TECHNICAL DATA

- Ventilated evaporation system
- VEG without storage
- All door models without reservation

CARACTÉRISTIQUES TECHNIQUES DES ANGLES RÉFRIGÉRÉS

- Système d'évaporation ventilé
- VEG stockage
- Tous les modèles sans portes de réserve

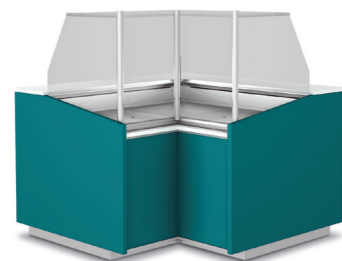

VEGPC-10-RN90 5.848 €

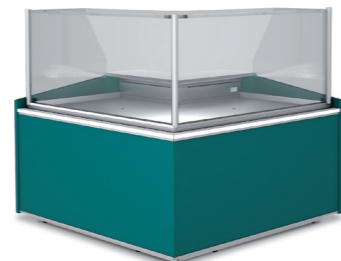

VEGPC-10-RP90 5.437 €

230v 60Hz / 115v 60Hz. consultar - consult - consulter

OPCIONES · OPTIONS · OPTIONS

Modelo	Neutra	Pre Instalación Remote Unit	Puertas Cierre Plexi
Model	Neutral	Plexi slide	Doors
Modèle	Neutre	Groupe à distance	Kit vitrage arrière coulissant plexi
VEGPC-10-RP90	-513 €	-148 €	112 €
VEGPC-10-RN90	-513 €	-148 €	112 €

Características técnicas y constructivas sujetas a variación sin previo aviso / We reserve the right to change specifications without prior notice / Sujet technique et la conception de modifications sans préavis

CARACTERÍSTICAS TÉCNICAS MUEBLES CAJAS MCVEG

- Todos los modelos con cajón incorporado, estantes y enchufe
- Decoración incluida

CASH NEUTRAL COUNTER DATA MCVEG

- All models include drawer, shelves and plug
- Decoration included

CARACTÉRISTIQUES TECHNIQUES DES MEUBLE CAISSE MCVEG

- Tous les modèles avec tiroir incorporé, étagères et prise électrique
- Décoration inclus

CARACTERÍSTICAS TÉCNICAS MUEBLES CAJAS MCT

- Exterior en madera MDF hidrofuga según color
- Interior en acero prepintado gris
- 4 Estantes de cristal regulables en inclinación
- De serie: Luz vertical led
- Gran visibilidad de producto, laterales y frontal acristalados
- Lacado según color RAL

CASH NEUTRAL COUNTER DATA MCT

- MDF wood exterior water leak according to color
- Gray prepainted steel interior
- 4 Glass shelves adjustable in inclination
- Standard: led vertical light
- High product visibility, side and front glazing
- Lacquered according to RAL color

CARACTÉRISTIQUES TECHNIQUES DES MEUBLE CAISSE MCT

- Bois extérieur MDF repoussant par couleur
- Prépeinte intérieur gris acier
- 4 tablettes en verre réglables en inclinaison
- Série: lumière verticale LED
- Grande visibilité du produit, côté frontal et vitrés
- Laqué selon RAL

DETALLE
DETAIL / DETAIL



MUEBLES CAJA NEUTROS
NEUTRAL CASH COUNTER / MEUBLE CAISSE NEUTRE

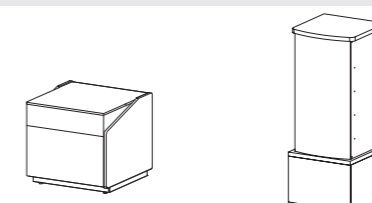

MCVEG-10-10 1.303 € MCT-70-VEG 1.650 €

MOSTRADORES
COUNTER / COMPTEUR

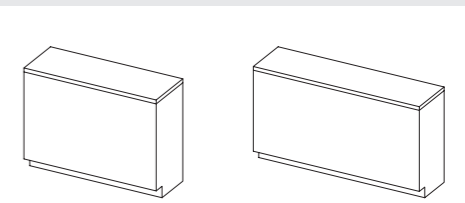

MG-150 1.267 € MG-200 1.477 €

Modelo	Largo	Alto	Fondo	Cámara	Exposición	Puertas	Potencia frig.	Consumo	Refrigerante
Model	Length	Height	Depth	Storage	Display	Doors	Frig. Power	Consumption	Coolant
Modèle	Longueur	Hauteur	Profondeur	Stockage	Exposition	Portes	Puissance frig.	Consommation	Réfrigérant
VEGPC-10-RN90	1410	1290	1410	-	0,61	0	1315	1335	R-452A
VEGPC-10-RP90	1395	1290	1395	-	0,99	0	1315	1335	R-452A
MCVEG-10-10	1000	900	1000	-	0,48	0	-	-	-
MCT-70-VEG	700	1850	700	-	1,85	-	-	-	-
MG-150	1500	1090	600	-	0,53	0	-	-	-
MG-200	2000	1090	600	-	1,01	0	-	-	-

OTHELLO



Othello 100

CARACTERÍSTICAS PRINCIPALES

- Vitrina en Acero inoxidable 304.
- Termostato electrónico para una mejor regulación de la temperatura.
- Luz LED en cada estante que posibilita un mayor protagonismo del producto.
- Refrigeración dinámica para asegurar una temperatura estable.
- Cristal curvo con calefacción para evitar la condensación.



Puertas correderas.



Termómetros para la lectura a distancia.



Luz LED en cada estante

Servicios opcionales*



Aplicación



CARACTERÍSTICAS TÉCNICAS

MODELO	Othello 100	
Código		0ITC0550
Capacidad neta	L	200
Capacidad bruta	L	230
Rango de temperatura	°C	+1 / +8
Alimentación eléctrica	V / Ph / Hz	230 / 1 / 50
Potencia eléctrica	W	596
Clase climática	Tipo	4
Desescarche	Tipo	Automático
Refrigerante	Tipo	R-134a
Estantes	nº	3
Ancho / fondo / alto	mm	1000 / 740 / 1275
Peso bruto / neto	kg	285 / 200
PVP		3656 €

*Para contratar Servicios opcionales ver final del catálogo.
Reservados los derechos a modificar modelos y datos técnicos.

METRO

★ PRODUCTO PREMIUM



93 N VA ST



93 N VA LX

CARACTERÍSTICAS PRINCIPALES

- Vitrina self service con puertas de vidrio templado y marco posterior en aluminio anodizado plateado o vitrina asistida con puertas correderas de vidrio templado y marco posterior en aluminio anodizado plateado.
- Base de exposición, superfi cie superior de servicio, panel posterior , rejilla frontal y estructura superior con soporte y estantes regulables en dos posiciones en brillante acero inoxidable.
- Laterales de vidrio que maximizan la visibilidad.
- 3 estantes de vidrio templado con luz LED en cada uno.
- Patas regulables.
- Centralita electrónica en el lado del operador.
- Termómetro digital en el interior.
- Control de temperatura con desescarche automático por parada de compresor.



3 estantes de vidrio templado con luz LED.



Laterales de vidrio que maximizan la visibilidad.



Patas regulables.

Servicios opcionales*

Aplicación

Características



CARACTERÍSTICAS TÉCNICAS

MODELO	CRISTAL RECTO					
	93 N VA ST	129 N VA ST	93 RV VA ST	129 RV VA ST	93 RV LS ST	129 RV LS ST
Código	ⓂOLIS1053ST	ⓂOLIS1054ST	ⓂOLIS1055ST	ⓂOLIS1056ST	ⓂOLIS1057ST	ⓂOLIS1058ST
Capacidad neta	L 167	233	150	210	125	185
Capacidad bruta	L 385	535	385	535	385	535
Rango de temperatura	°C - / -	- / -	-1 / +5	-1 / +5	-1 / +7	-1 / +7
Alimentación eléctrica	V / Ph / Hz 230 / 1 / 50	230 / 1 / 50	230 / 1 / 50	230 / 1 / 50	230 / 1 / 50	230 / 1 / 50
Potencia eléctrica	W -	-	880	980	1270	1500
Clase climática	Tipo -	-	3	3	3	3
Desescarche	Tipo -	-	Automático	Automático	Automático	Automático
Evaporador	Tipo -	-	Ventilado	Ventilado	Ventilado	Ventilado
Refrigerante	Tipo R-404A	R-404A	R-404A	R-404A	R-404A	R-404A
Ancho / fondo / alto	mm 950 / 840 / 1327	1305 / 840 / 1327	950 / 840 / 1327	1305 / 840 / 1327	950 / 840 / 1327	1305 / 840 / 1327
Peso neto	kg 200	250	330	430	330	400
PVP	3407 €	4177 €	5808 €	6787 €	6247 €	7479 €

MODELO	CRISTAL CURVO					
	93 N VA LX	129 N VA LX	93 RV VA LX	129 RV VA LX	93 RV LS LX	129 RV LS LX
Código	ⓂOLIS1053LX	ⓂOLIS1054LX	ⓂOLIS1055LX	ⓂOLIS1056LX	ⓂOLIS1057LX	ⓂOLIS1058LX
Capacidad neta	L 167	233	150	210	125	185
Capacidad bruta	L 385	535	385	535	385	535
Rango de temperatura	°C - / -	- / -	-1 / +5	-1 / +5	-1 / +7	-1 / +7
Alimentación eléctrica	V / Ph / Hz 230 / 1 / 50	230 / 1 / 50	230 / 1 / 50	230 / 1 / 50	230 / 1 / 50	230 / 1 / 50
Potencia eléctrica	W -	-	880	980	1270	1500
Clase climática	Tipo -	-	3	3	3	3
Desescarche	Tipo -	-	Automático	Automático	Automático	Automático
Evaporador	Tipo -	-	Ventilado	Ventilado	Ventilado	Ventilado
Refrigerante	Tipo R-404A	R-404A	R-404A	R-404A	R-404A	R-404A
Ancho / fondo / alto	mm 950 / 852 / 1338	1305 / 852 / 1338	950 / 852 / 1338	1305 / 852 / 1338	950 / 852 / 1338	1305 / 852 / 1338
Peso neto	kg 200	250	330	430	330	400
PVP	3407 €	4177 €	5808 €	6787 €	6247 €	7479 €

Ⓜ Consultar stock disponible

*Para contratar Servicios opcionales ver final del catálogo.

Reservados los derechos a modificar modelos y datos técnicos.

PRISMA



Prisma 400 BT



Prisma 800 R-G TN

CARACTERÍSTICAS PRINCIPALES

- Armarios expositores verticales con cuatro caras de cristal para una visión panorámica del producto expuesto.
- Perfiles exteriores en aluminio barnizado en color gris. Iluminación interior mediante fluorescente vertical para una óptima visibilidad a lo largo de toda la vitrina.
- Triple cristal para asegurar la mínima dispersión térmica y la perfecta conservación del producto.
- Incluye cuadro de control electrónico y estantes de aluminio.



Perfiles exteriores en aluminio barnizado color gris.



Triple cristal.

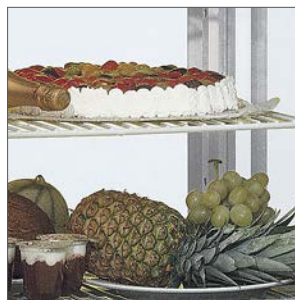

Estantes de aluminio para evitar problemas de oxidación.



Iluminación interior.

Servicios opcionales*



Aplicación



CARACTERÍSTICAS TÉCNICAS

MODELO	CONSERVACIÓN			
	Prisma 400 G TN	Prisma 400 R TN	Prisma 800 G TN	Prisma 800 R-G TN
Código	01CL0022	01CL0023	01CL0025	01CL0026
Capacidad neta	L 400	400	800	800
Rango de temperatura	°C +4 / +10	+4 / +10	+4 / +10	+4 / +10
Alimentación eléctrica	V / Ph / Hz 230 / 1 / 50	230 / 1 / 50	230 / 1 / 50	230 / 1 / 50
Potencia eléctrica	W 590	590	850	850
Clase climática	Tipo 3	3	3	3
Condensación	Tipo Ventilada	Ventilada	Ventilada	Ventilada
Desescarche	Tipo Automático	Automático	Automático	Automático
Evaporador	Tipo Ventilado	Ventilado	Ventilado	Ventilado
Refrigerante	Tipo R-404A	R-404A	R-404A	R-404A
Ancho / fondo / alto	mm 680 / 690 / 1820	680 / 690 / 1820	1270 / 690 / 1820	1270 / 690 / 1820
Peso bruto / neto	kg 185 / 160	193 / 168	275 / 250	285 / 260
PVP	2575 €	2696 €	4004 €	4183 €

MODELO	CONGELACIÓN		MIXTOS
	Prisma 400 BT	Prisma 800 BT	Prisma 800 TN / BT GT-G
Código	01TF0611	01CL0011	Ⓜ 01CL0014
Capacidad neta	L 400	800	800
Rango de temperatura	°C -5 / -7	-5 / -17	+4 / +10
Alimentación eléctrica	V / Ph / Hz 230 / 1 / 50	230 / 1 / 50	230 / 1 / 50
Potencia eléctrica	W 600	940	1180
Clase climática	Tipo 3	3	3
Condensación	Tipo Ventilada	Ventilada	Ventilada
Desescarche	Tipo Manual	Manual	Manual
Evaporador	Tipo Estático	Estático	Ventilado/Estático
Refrigerante	Tipo R-404A	R-404A	R-404A
Ancho / fondo / alto	mm 680 / 690 / 1820	1270 / 690 / 1820	1270 / 658 / 1820
Peso bruto / neto	kg 195 / 178	305 / 280	315 / 290
PVP	3129 €	5038 €	5363 €

ACCESORIOS	Estante rotativo (Prisma 400 R)	Estante rejilla (Prisma 400 G)
Código	01CL9030K	01CL9035K
PVP	80 €	91 €

Ⓜ Consultar stock disponible

*Para contratar Servicios opcionales ver final del catálogo.

Reservados los derechos a modificar modelos y datos técnicos.

SNELLE 350

★ PRODUCTO PREMIUM



Snelle 350 G New



Snelle 350 Q New



Snelle 350 R New

CARACTERÍSTICAS PRINCIPALES

- Armarios expositores de cuatro caras de cristal de 350 litros para una visión panorámica del producto expuesto. Estructura en aluminio anodizado resistente a la corrosión.
- Disponible en versión conservación y en color plateado. Color dorado bajo petición. Iluminación interior con luz LED para realzar la visibilidad del producto expuesto a lo largo de toda la vitrina.
- Triple cristal para un aislamiento perfecto y un consumo energético óptimo.
- Incluye cuadro de control electrónico y estantes.



Estructura en aluminio anodizado resistente a la corrosión..



Cuadro de control electrónico.



Modelos en color plateado.



Iluminación LED.

Servicios opcionales*



Aplicación



Características



LUZ LED

CARACTERÍSTICAS TÉCNICAS

MODELO	BITEMPERATURA				
	Snelle 350 Q New	Snelle 350 G New	Snelle 350 R New	Snelle 350 BTV BIS New	Snelle 350 RBT BIS New
Código	OITF1160	OITF1140	OITF1120	OITF1182	OITF1181
Capacidad neta	L 350	350	350	350	350
Rango de temperatura	°C +4 / +10	+4 / +10	+4 / +10	+5 / -18	+5 / -18
Alimentación eléctrica	V / Ph / Hz 230 / 1 / 50	230 / 1 / 50	230 / 1 / 50	230 / 1 / 50	230 / 1 / 50
Potencia eléctrica	W 600	600	650	620	640
Clase climática	Tipo 4	4	4	4	4
Condensación	Tipo Ventilada	Ventilada	Ventilada	Ventilada	Ventilada
Desescarche	Tipo Automático	Automático	Automático	Automático	Automático
Evaporador	Tipo Ventilado	Ventilado	Ventilado	Ventilado	Ventilado
Refrigerante	Tipo R-404A	R-404A	R-404A	R-404A	R-404A
Ancho / fondo / alto	mm 595 / 658 / 1810	595 / 658 / 1810	595 / 658 / 1810	595 / 658 / 1810	595 / 658 / 1810
Peso bruto / neto	kg 169 / 143	165 / 139	172 / 146	167 / 152	175 / 160
PVP	2908 €	2971 €	3186 €	4355 €	4621 €

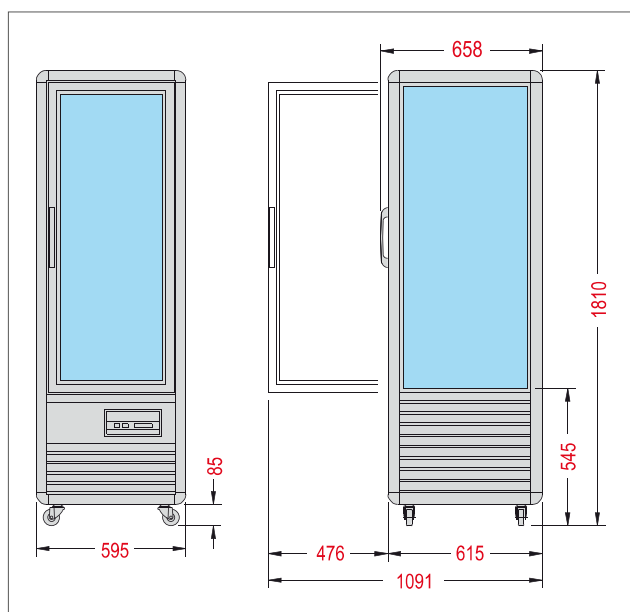

Snelle 350 G New

ACCESORIOS	Estante rejilla con soporte
Código	OITF9102K
PVP	132 €

*Para contratar Servicios opcionales ver final del catálogo.
Reservados los derechos a modificar modelos y datos técnicos.

SNELLE 400 / 505

★ PRODUCTO PREMIUM



Snelle 505 R New



Snelle 400 GBT New



Snelle 505 Q New

CARACTERÍSTICAS PRINCIPALES

- Armarios expositores de cuatro caras de cristal de 400 a 500 litros para una visión panorámica del producto expuesto. Estructura en aluminio anodizado resistente a la corrosión.
- Disponible en versión conservación, congelación y bitemperatura, en color plateado. Color dorado bajo petición.
- Iluminación interior con luz LED para realzar la visibilidad del productos expuesto a lo largo de toda la vitrina.
- Triple cristal para un aislamiento perfecto y un consumo energético óptimo.
- Incluye cuadro de control electrónico y estantes.



Estructura en aluminio anodizado resistente a la corrosión.



Cuadro de control electrónico.



Modelos en color plateado.



Iluminación LED.

Servicios opcionales*

Aplicación

Características

CARACTERÍSTICAS TÉCNICAS

MODELO	CONSERVACIÓN		CONGELACIÓN
	Snelle 505 Q New	Snelle 505 R New	Snelle 400 GBT New
Código	OITF0301	OITF0261	OITF1180
Capacidad neta	L 500	500	400
Rango de temperatura	°C +4 / +10	+4 / +10	-5 / -18
Alimentación eléctrica	V / Ph / Hz 230 / 1 / 50	230 / 1 / 50	230 / 1 / 50
Potencia eléctrica	W 660	760	700
Clase climática	Tipo 4	4	4
Condensación	Tipo Ventilada	Ventilada	Ventilada
Desescarche	Tipo Automático	Automático	Manual
Evaporador	Tipo Ventilado	Ventilado	Estático
Refrigerante	Tipo R-404A	R-404A	R-404A
Ancho / fondo / alto	mm 700 / 770 / 1810	700 / 770 / 1810	595 / 658 / 1810
Peso bruto / neto	kg 202 / 179	200 / 177	312 / 293
PVP	3981 €	4565 €	3569 €

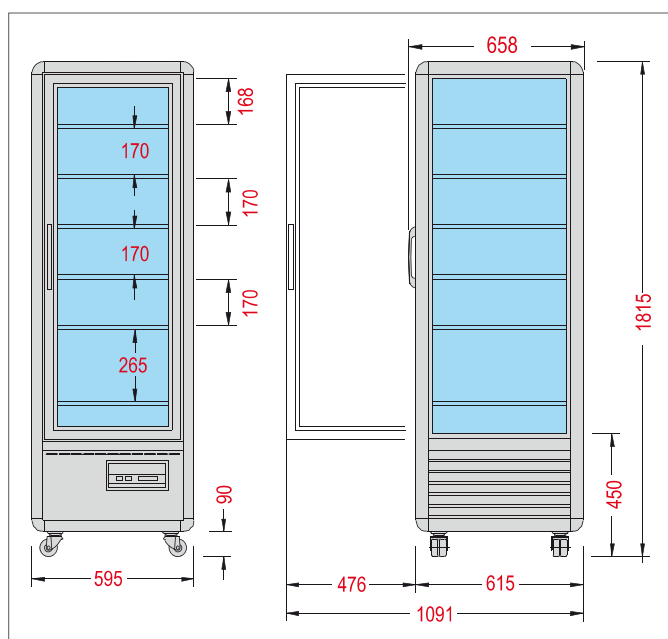

Snelle 400 GBT New

*Para contratar Servicios opcionales ver final del catálogo.
Reservados los derechos a modificar modelos y datos técnicos.

DIVA

★ PRODUCTO PREMIUM



Diva 450 GS



Diva 450 BTV BIS



Diva 650 BTV BIS



Diva 650 GS

CARACTERÍSTICAS PRINCIPALES

- Armarios expositores de cuatro caras de cristal de 450 a 650 litros para una visión panorámica del producto expuesto. Estructura en aluminio anodizado resistente a la corrosión.
- Disponible en versión conservación y congelación en color plateado. Color negro bajo petición.
- Iluminación interior con luz LED para realzar la visibilidad del productos expuesto a lo largo de toda la vitrina.
- Triple cristal para un aislamiento perfecto y un consumo energético óptimo.
- Incluye cuadro de control electrónico y estantes.



Estructura en aluminio anodizado resistente a la corrosión.



Cuadro de control electrónico.



Modelos disponibles en color negro. Bajo pedido.



Tecnología LED de serie.

Servicios opcionales*

Aplicación

Características

LUZ LED

CARACTERÍSTICAS TÉCNICAS

MODELO	CONSERVACIÓN		CONGELACIÓN	
	Diva 450 GS	Diva 650 GS	Diva 450 BTV BIS	Diva 650 BTV BIS
Código	0ITF1610	0ITF1620	0ITF1630	0ITF1640
Capacidad neta	L 450	650	450	650
Rango de temperatura	°C +4 / +10	+4 / +10	+5 / -18	+5 / -18
Alimentación eléctrica	V / Ph / Hz 230 / 1 / 50	230 / 1 / 50	230 / 1 / 50	230 / 1 / 50
Potencia eléctrica	W 720	590	1020	1040
Clase climática	Tipo 4	4	4	4
Condensación	Tipo Ventilada	Ventilada	Ventilada	Ventilada
Desescarche	Tipo Automático	Automático	Automático	Automático
Evaporador	Tipo Estático	Estático	Ventilado	Ventilado
Refrigerante	Tipo R-404A	R-404A	R-404A	R-404A
Ancho / fondo / alto	mm 700 / 680 / 1910	900 / 680 / 1910	700 / 680 / 1910	900 / 680 / 1910
Peso neto	kg 171	223	197	225
PVP	4307 €	4788 €	6012 €	6821 €

*Para contratar Servicios opcionales ver final del catálogo.
Reservados los derechos a modificar modelos y datos técnicos.

CRISTAL TOWER

★ PRODUCTO PREMIUM



RS 725 TB

CARACTERÍSTICAS PRINCIPALES

- Cristal Tower es una joya del diseño y la tecnología que supera la barrera entre el cliente y el producto incluso en puntos de venta de pequeñas dimensiones.
- Máxima transparencia gracias a sus 4 laterales y estantes de vidrio que dan el máximo protagonismo al producto expuesto.
- Iluminación LED, máxima iluminación con mínimo consumo, sin calentar el producto ni afectar a su organolepsia.
- Estructura de acero que garantiza la robustez sin disminuir la elegancia.
- Máximo silencio.
- Capacidad expositiva sinpar con máxima visibilidad desde todos los puntos de vista.
- Tecnología Touch. Una forma simple, rápida e intuitiva de regular Cristal Tower. Sólo tiene que tocar los iconos serigrafiados.
- Estante de base en vidrio con iluminación LED. Otro punto de luz para aumentar aún más la fuerza expositiva. (no incluido en modelo TB).
- Dispositivo de apertura de puerta con sistema Touch Pad directamente sobre el vidrio (opcional). Tocando el botón de apertura se ilumina la luz verde y se abre la puerta automáticamente (sin tirador).
- Cierre automático y delicado de puerta (opcional).



Dispositivo de apertura de puerta con sistema Touch Pad directamente sobre el vidrio (opcional).

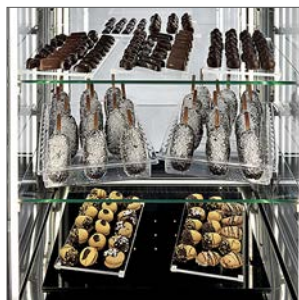

Estante de base en vidrio con iluminación LED.



Tecnología Touch.

Servicios opcionales*

Aplicación

Características

CARACTERÍSTICAS TÉCNICAS

MODELO		CONSERVACIÓN		CONGELACIÓN	
		RV 725 TN	RV 925 TN	RS 725 TB	RS 925 TB
Código		0IIS0022	0IIS0026	0IIS0027	0IIS0023
Capacidad neta	L	372	500	398	536
Rango de temperatura	°C	+1 / +10	+1 / +10	-15 / -18	-15 / -18
Alimentación eléctrica	V / Ph / Hz	230 / 1 / 50	230 / 1 / 50	230 / 1 / 50	230 / 1 / 50
Potencia eléctrica	W	630	650	630	850
Potencia eléctrica en desescarche	W	150	160	-	-
Clase climática	Tipo	4	4	4	4
Desescarche	Tipo	Automático	Automático	Manual	Manual
Evaporador	Tipo	Ventilado	Ventilado	Estático	Estático
Refrigerante	Tipo	R-404A	R-404A	R-404A	R-404A
Ancho / fondo / alto	mm	725 / 664 / 1990	925 / 664 / 1990	725 / 664 / 1990	925 / 664 / 1990
Peso neto	kg	245	305	236	275
PVP		5242 €	5778 €	5987 €	6584 €

MODELO		CONSERVACIÓN / CONGELACIÓN		VERSIÓN PASTERERÍA	
		RV 725 TB/TN	RV 925 TB/TN	RV 725 CH	RV 925 CH
Código		0IIS0021	0IIS0025	⊕0IIS0019	0IIS0024
Capacidad neta	L	372	500	372	500
Rango de temperatura	°C	-18 / +10	-18 / +10	+14 / +16	+14 / +16
Alimentación eléctrica	V / Ph / Hz	230 / 1 / 50	230 / 1 / 50	230 / 1 / 50	230 / 1 / 50
Potencia eléctrica	W	920	1000	630	650
Potencia eléctrica en desescarche	W	1500	1700	150	160
Clase climática	Tipo	4	4	4	4
Desescarche	Tipo	Automático	Automático	Automático	Automático
Evaporador	Tipo	Ventilado	Ventilado	Ventilado	Ventilado
Refrigerante	Tipo	R-404A	R-404A	R-404A	R-404A
Ancho / fondo / alto	mm	725 / 664 / 1990	925 / 664 / 1990	725 / 664 / 1990	925 / 664 / 1990
Peso neto	kg	245	305	245	305
PVP		7007 €	7852 €	5834 €	6422 €

⊕ Consultar stock disponible

*Para contratar Servicios opcionales ver final del catálogo.

Reservados los derechos a modificar modelos y datos técnicos.

SNELLE 750 / 1010

★ PRODUCTO PREMIUM



Snelle 750 GBT New



Snelle 1010 G New

CARACTERÍSTICAS PRINCIPALES

- Armarios expositores de cuatro caras de cristal de 750 a 1000 litros para una visión panorámica del producto expuesto. Estructura en aluminio anodizado resistente a la corrosión.
- Disponible en versión conservación, congelación y bitemperatura, en color plateado. Color dorado bajo petición.
- Iluminación interior con luz LED para realzar la visibilidad de los productos expuestos a lo largo de toda la vitrina.
- Triple cristal para un aislamiento perfecto y un consumo energético óptimo.
- Incluye cuadro de control electrónico y estantes.



Estructura en aluminio anodizado resistente a la corrosión.



Cuadro de control electrónico.



Modelos new disponibles en color plateado.



Iluminación LED.



CARACTERÍSTICAS TÉCNICAS

MODELO	CONGELACIÓN		CONSERVACIÓN		BITEMPERATURA
	Snelle 750 GBT New	Snelle 750 GBT-VU New	Snelle 1010 G New	Snelle 1010 Q New	Snelle 1010 GBT-G New
Código	OITF1240	OITF1245	OITF0361	OITF0371	OITF0366
Capacidad neta L	750	750	1000	1000	1000
Rango de temperatura °C	-5 / -18	-5 / -18	+4 / +10	+4 / +10	+4; +10 / -10; -19
Alimentación eléctrica V / Ph / Hz	230 / 1 / 50	230 / 1 / 50	230 / 1 / 50	230 / 1 / 50	230 / 1 / 50
Potencia eléctrica W	1270	1270	800	800	1550
Clase climática Tipo	4	4	4	4	4
Condensación Tipo	Ventilada	Ventilada	Ventilada	Ventilada	Ventilada
Desescarche Tipo	Manual	Manual	Automático	Automático	Automático
Evaporador Tipo	Estático	Estático	Ventilado	Ventilado	Ventilado
Refrigerante Tipo	R-404A	R-404A	R-404A	R-404A	R-404A
Ancho / fondo / alto mm	1145 / 658 / 1810	1145 / 658 / 1810	1350 / 770 / 1810	1350 / 770 / 1810	1350 / 770 / 1810
Peso bruto / neto kg	290 / 270	290 / 239	292 / 256	312 / 276	312 / 293
PVP	6078 €	5984 €	5999 €	5999 €	7114 €

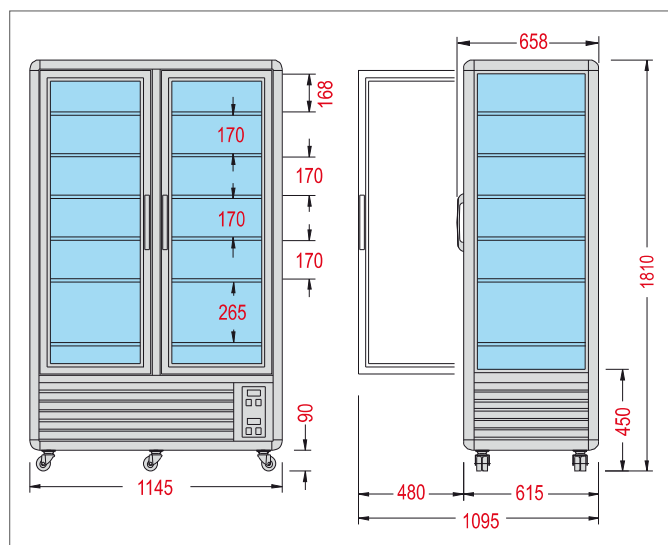

Snelle 750 GBT New

ACCESORIOS	Estante con soporte Snelle 1010 G
Código	OITF9110K
PVP	74 €

*Para contratar Servicios opcionales ver final del catálogo.
Reservados los derechos a modificar modelos y datos técnicos.

VITRINAS PASTELERAS

MODELO	°C	DIMENSIONES MM				WAT	KG	M3 EMB	PVP
		L	A	H	BASE-CRIST-TOTAL				



TOP TAP JR 4 -1000	-4°C	1000	705	173+360	533	1 estante	300	50	0,7	3.410€
1250	-4°C	1250	705	173+360	533	1 estante	320	53	0,8	3.760€
1500	-4°C	1500	705	173+360	533	1 estante	380	64	1,0	4.080€
1750	-4°C	1750	705	173+360	533	1 estante	450	75	1,1	4.580€

Modelo sobremesa. Con 1 estante de 230 mm, de cristal templado, (170 mm de altura útil).

Estructura en acero inox 304. Decoración de serie en corian blanco

Cristal templado, extra claro... Iluminación por led. Su ajuste puede ser mediante uniones plexiglas o encolado

Tropicalizadas. Frío ventilado controlado mediante termostato electrónico de alta precisión. Desescarche automático

Evaporador tratado con pintura atóxica y aislamiento de poliuretano ecológico, densidad 42 kg/m3. Humedad 60/70%

Voltaje: 230 F+N



MAGNO LUS 1104 1000	-4°C	1000	712	520+630	1150	1 estante	800	90	1,1	5.975€
1104 1250	-4°C	1250	712	520+630	1150	1 estante	900	110	1,4	6.360€
1104 1500	-4°C	1500	712	520+630	1150	1 estante	1000	130	1,6	7.495€
1104 1750	-4°C	1750	712	520+630	1150	1 estante	1300	150	1,9	8.355€

MAGNO LUS 1404 1000	-4°C	1000	712	520+872	1392	3 estante	800	90	1,5	6.915€
1404 1250	-4°C	1250	712	520+872	1392	3 estante	900	110	1,9	7.285€
1404 1500	-4°C	1500	712	520+872	1392	3 estante	1000	130	2,2	7.795€
1404 1750	-4°C	1750	712	520+872	1392	3 estante	1300	150	2,5	8.485€

MAGNO LUS 1118 1100	-18°C	1100	712	520+630	1150	1 estante	1000	96	1,2	8.775€
1118 1600	-18°C	1600	712	520+630	1150	1 estante	1500	150	1,7	12.120€

MAGNO LUS 1418 1100	-18°C	1100	712	520+872	1392	3 estante	1000	96	1,7	10.500€
1418 1600	-18°C	1600	712	520+872	1392	3 estante	1500	150	2,3	13.300€



VENUS VUS 1404 1000	-4°C	1000	833	598+800	1398	3 estante	800	90	1,7	7.255€
1404 1250	-4°C	1250	833	598+800	1398	3 estante	900	110	2,1	7.735€
1404 1500	-4°C	1500	833	598+800	1398	3 estante	1000	130	2,5	8.110€
1404 1750	-4°C	1750	833	598+800	1398	3 estante	1300	150	2,9	8.745€

VENUS VUS 1418 1100	-18°C	1100	833	598+800	1398	3 estante	1000	96	1,9	14.700€
1418 1600	-18°C	1600	833	598+800	1398	3 estante	1500	150	2,7	17.700€

Estantes de cristal templado. De distinto ancho para una perfecta visión. Altura útil entre ellos 170 mm)

Doble cristal templado, extra claro. Calefactado para evitar la condensación en mod -18°C.

Traseras correderas, con marco de acero y autocierre (si se desea) en mod -4°C. Abatible/calefactada en -18°C

Cristal frontal abatible neumático en modelo VENUS

Iluminación por led en la parte superior anterior y posterior. A voluntad se puede colocar en todos los estantes

Estructura en acero inox 304. Decoración de serie en corian blanco, con cristal tintado (blanco, gris o negro)

Tropicalizadas. Frío ventilado controlado mediante termostato electrónico de alta precisión. Desescarche automático

Evaporador tratado con pintura atóxica y aislamiento de poliuretano ecológico, densidad 42 kg/m3. Humedad 60/70%

Voltaje: 230 F+N

Existe canalización (Kit de unión para la parte frontal inferior) sin coste, para más de 1 unidad. Indicarlo en pedido
Disponibles también en motor a distancia

VITRINAS PASTELERAS

MODELO	°C	DIMENSIONES MM				WAT	KG	M3 EMB	PVP
		L	A	H	BASE-CRIST-TOTAL				



PLATINO PL 120-1170	-4°C	1170	1080	720+510	1230	sin estante	800	140	2,2	5.500€
120-1715	-4°C	1715	1080	720+510	1230	sin estante	1000	190	3,2	6.400€
120-2190	-4°C	2190	1080	720+510	1230	sin estante	1500	250	4,0	7.200€

Estructura en acero inox 304. Decoración de serie en corian blanco

Cristal templado, extra claro. Iluminación mediante led

Tropicalizadas. Frío ventilado controlado mediante termostato electrónico de alta precisión. Desescarche automático

Evaporador tratado con pintura atóxica y aislamiento de poliuretano ecológico, densidad 42 kg/m3. Humedad 60/70%

Voltaje: 230 F+N



SENIOR 2-QU 120-1170	-4°C	1170	1252	623+587	1210	1 estante	800	140	2,5	4.980€
120-1715	-4°C	1715	1252	623+587	1210	1 estante	1000	190	3,6	5.950€
120-2190	-4°C	2190	1252	623+587	1210	1 estante	1500	250	4,5	6.800€

SENIOR 2-QU 140-1170	-4°C	1170	1252	623+777	1400	2 estante	800	150	2,9	5.700€
140-1715	-4°C	1715	1252	623+777	1400	2 estante	1000	200	4,1	6.600€
140-2190	-4°C	2190	1252	623+777	1400	2 estante	1500	260	5,1	7.600€



SENIOR 1-TI 120-1170	-4°C	1170	1254	730+507	1237	1 estante	800	140	2,6	5.850€
120-1715	-4°C	1715	1254	730+507	1237	1 estante	1000	190	3,6	6.790€
120-2190	-4°C	2190	1254	730+507	1237	1 estante	1500	250	4,6	7.680€

SENIOR 1-TI 140-1170	-4°C	1170	1254	730+650	1380	2 estante	800	150	2,9	6.750€
140-1715	-4°C	1715	1254	730+650	1380	2 estante	1000	200	4,2	7.450€
140-2190	-4°C	2190	1254	730+650	1380	2 estante	1500	260	5,2	8.450€

Estantes de cristal templado, de 252 mm de profundidad y 200 de altura útil

Estructura en acero inox 304. Decoración de serie en corian blanco. Cristales tintados en gris

Cristal templado, extra claro. Iluminación por led en la parte superior anterior y posterior. Traseras correderas

Tropicalizadas. Frío ventilado controlado mediante termostato electrónico de alta precisión. Desescarche automático

Evaporador tratado con pintura atóxica y aislamiento de poliuretano ecológico, densidad 42 kg/m3. Humedad 60/70%

Voltaje: 230 F+N

Existe canalización (Kit de unión para la parte frontal inferior) sin coste, para más de 1 unidad. Indicarlo en pedido
Disponibles también en motor a distancia



Composición: MAGNO LUS 1404 + 1018

VITRINAS PASTELERAS

MODELO	°C	DIMENSIONES MM					WAT	KG	M3 EMB	PVP		
		L	A	H	BASE-CRIST-TOTAL							
	ELEGANCE F MINI 2i 1000	-4°C	1000	740	915+250	1165	sin estante	400	90	1,3	4.420€	
	1500	-4°C	1500	740	915+250	1165	sin estante	600	130	1,9	4.885€	
	2000	-4°C	2000	740	915+250	1165	sin estante	800	190	2,5	5.695€	
	ELEGANCE F MINI 2i 1000 R	-4°/-4°	1000	740	915+250	1165	sin estante	400	Reserva 1 p	120	1,3	5.940€
	1500 R	-4°/-4°	1500	740	915+250	1165	sin estante	600	Reserva 2 p	150	1,9	7.200€
	2000 R	-4°/-4°	2000	740	915+250	1165	sin estante	800	Reserva 3 p	210	2,5	8.500€
	ELEGANCE F MINI 4i 1000	-4°	1000	740	915+400	1315	1 estante	400	Reserva 1 p	95	1,5	4.600€
	1500	-4°	1500	740	915+400	1315	1 estante	600	Reserva 2 p	135	2,2	5.250€
	2000	-4°	2000	740	915+400	1315	1 estante	800	Reserva 3 p	200	2,8	5.890€
	ELEGANCE F MINI 4i 1000 R	-4°/-4°	1000	740	915+400	1315	1 estante	400		125	1,5	6.200€
	1000 R	-4°/-4°	1500	740	915+400	1315	1 estante	600		155	2,2	7.600€
	1000 R	-4°/-4°	2000	740	915+400	1315	1 estante	800		220	2,8	8.700€
	ELEGANCE F MIDI 2i 1000	-4°	1000	910	915+250	1165	sin estante	600		105	1,6	4.605€
	1500	-4°	1500	910	915+250	1165	sin estante	800		130	2,3	5.145€
	2000	-4°	2000	910	915+250	1165	sin estante	1000		190	3,0	5.910€
	ELEGANCE F MIDI 2i 1000 R	-4°/-4°	1000	910	915+250	1165	sin estante	700	Reserva 1 p	130	1,6	6.300€
	1500 R	-4°/-4°	1500	910	915+250	1165	sin estante	900	Reserva 2 p	150	2,3	7.400€
	2000 R	-4°/-4°	2000	910	915+250	1165	sin estante	1100	Reserva 3 p	210	3,0	8.995€
	ELEGANCE F MIDI 4i 1000	-4°	1000	910	915+400	1315	1 estante	600		110	1,8	4.750€
	1500	-4°	1500	910	915+400	1315	1 estante	800		135	2,6	5.500€
	2000	-4°	2000	910	915+400	1315	1 estante	1000		200	3,3	6.100€
	ELEGANCE F MIDI 4i 1000 R	-4°/-4°	1000	910	915+400	1315	1 estante	700	Reserva 1 p	135	1,8	6.500€
	1500 R	-4°/-4°	1500	910	915+400	1315	1 estante	900	Reserva 2 p	155	2,6	7.800€
	2000 R	-4°/-4°	2000	910	915+400	1315	1 estante	1100	Reserva 3 p	220	3,3	9.200€
	ELEGANCE F MAXI 2i 1000	-4°	1000	1111	915+250	1165	sin estante	800		122	1,9	5.300€
	1500	-4°	1500	1111	915+250	1165	sin estante	1000		154	2,7	5.995€
	2000	-4°	2000	1111	915+250	1165	sin estante	1200		212	3,6	6.840€
	ELEGANCE F MAXI 2i 1000 R	-4°/-4°	1000	1111	915+250	1165	sin estante	900	Reserva 1 p	142	1,9	6.995€
	1500 R	-4°/-4°	1500	1111	915+250	1165	sin estante	1100	Reserva 2 p	164	2,7	7.700€
	2000 R	-4°/-4°	2000	1111	915+250	1165	sin estante	1300	Reserva 3 p	222	3,6	9.900€
	ELEGANCE F MAXI 4i 1000	-4°C	1000	1111	915+400	1315	1 estante	800		128	2,1	5.490€
	1500	-4°C	1500	1111	915+400	1315	1 estante	1000		160	3,0	6.200€
	2000	-4°C	2000	1111	915+400	1315	1 estante	1200		218	4,0	6.995€
	ELEGANCE F MAXI 4i 1000 R	-4°/-4°	1000	1111	915+400	1315	1 estante	900	Reserva 1 p	148	2,1	7.100€
	1500 R	-4°/-4°	1500	1111	915+400	1315	1 estante	1100	Reserva 2 p	170	3,0	7.800€
	2000 R	-4°/-4°	2000	1111	915+400	1315	1 estante	1300	Reserva 3 p	228	4,0	10.150€

Opción cristal recto

Modelo 2 sin estante. Modelo 4 con 1 estante de cristal templado, de 250 mm y altura libre de 19 cm
Modelos R llevan reserva (2 evaporadores con temperatura independiente). Puede ser utilizada como barra de bar
Cristales ajustados con uniones plexiglas o encolado, a voluntad. Si función bar deben ser encolados
Estructura en acero inox 304. Decoración de serie en corian blanco. Cristal templado, extra claro. Iluminación por led
Tropicalizadas. Frío ventilado controlado mediante termostato electrónico de alta precisión. Desescarche automático
Evaporador tratado con pintura atóxica y aislamiento de poliuretano ecológico, densidad 42 kg/m3. Humedad 60/70%
Voltaje: 230 F+N. Disponible también con motor a distancia o frío estático

Existe canalización (Kit de unión para la parte frontal inferior) sin coste, para más de 1 unidad. Indicarlo en pedido

VITRINAS PASTELERAS

MODELO	°C	DIMENSIONES MM				WAT	KG	M3	PVP
		L	A	H	BASE-CRIST-TOTAL			EMB	



LADY SUP 1000	-4°C	1000	913	867+333	1200	sin estante	600	105	1,7	5.390€
1500	-4°C	1500	913	867+333	1200	sin estante	800	130	2,4	6.085€
2000	-4°C	2000	913	867+333	1200	sin estante	1000	190	3,1	6.705€

LADY SUP 1000 R	-4°/-4°	1000	913	867+333	1200	sin estante	700	Reserva 1 p	130	1,7	7.120€
1500 R	-4°/-4°	1500	913	867+333	1200	sin estante	900	Reserva 2 p	150	2,4	8.340€
2000 R	-4°/-4°	2000	913	867+333	1200	sin estante	1100	Reserva 3 p	210	3,1	9.800€



LADY SOW 1000	-4°C	1000	887	677+475	1152	1 estante	600		105	1,6	5.600€
1500	-4°C	1500	887	677+475	1152	1 estante	800		130	2,2	6.300€
2000	-4°C	2000	887	677+475	1152	1 estante	1000		190	2,9	6.900€

LADY SOW 1300-1000	-4°C	1000	887	677+625	1302	2 estante	600		110	1,7	5.995€
1300-1500	-4°C	1500	887	677+625	1302	2 estante	800		135	2,5	6.900€
1300-2000	-4°C	2000	887	677+625	1302	2 estante	1000		195	3,2	7.560€

LADY CORNER SOW	-4°C	1490	1490	677+475	1152		750		190	3,5	8.450€
------------------------	------	------	------	---------	------	--	-----	--	-----	-----	---------------

Modelo sup sin estante. Modelo sow con 1 estante de cristal templado, de 250 mm y altura libre de 27+20

Modelos R llevan reserva (2 evaporadores con temperatura independiente)

Cristales ajustados con uniones plexiglas o encolado, a voluntad. Si función bar deben ser encolados

Estructura en acero inox 304. Decoración de serie en corian blanco. Cristal y estantes templados, extra claros. Iluminación por led

Tropicalizadas. Frío ventilado controlado mediante termostato electrónico de alta precisión. Desescarche automático

Evaporador tratado con pintura atóxica y aislamiento de poliuretano ecológico, densidad 42 kg/m3. Humedad 60/70%

Voltaje: 230 F+N. Disponible también con motor a distancia o frío estático.



LUXURY CEL 1120		1120	855	583+370	953		600		105	1,4	9.700€
1620		1620	855	583+370	953		900		135	2,0	11.400€

Cristal multiestrato calefactado, elevable, extraclaro.



LUXURY CEL CENTER 1000		1000	826	693+199	892		600		105	1,2	7.060€
1500		1500	826	693+199	892		800		150	1,8	8.065€
2000		2000	826	693+199	892		1000		190	2,3	8.900€
2500		2500	826	693+199	892		1200		220	2,9	9.900€

Cristal templado, corredero, extraclaro. Estructura en acero inox 304.

Decoración de serie en corian blanco. Iluminación por led (2 líneas. En mod center, además 4 en ángulos, orientables).

Tropicalizadas. Frío ventilado controlado mediante termostato electrónico de alta precisión. Desescarche automático.

Evaporador tratado con pintura atóxica y aislamiento de poliuretano ecológico, densidad 42 kg/m3. Humedad 60/70%.

Voltaje: 230 F+N. Disponible también con motor a distancia o frío estático

Existe canalización (Kit de unión para la parte frontal inferior) sin coste, para más de 1 unidad. Indicarlo en pedido.

Los modelos "elegance" y "lady" se pueden canalizar juntas

El modelo "corner" puede ser, al mismo precio, en versión "sup" y "elegance"

VITRINAS PASTELERAS



Composición: LADY CORNER SOW

MODELO	°C	DIMENSIONES MM					WAT	KG	M3	PVP
		L	A	H	BASE-CRIST-TOTAL			EMB		



STILE VCPKPV-1	+2°C	1200	660	630+450	1115	1 estante	1000	90	1,4	5.735€
STILE VCPKPCV 14-1	+14°C	1200	660	630+450	1115	1 estante	1000	110	1,4	6.460€
STILE VNPKDV-1	-18°C	1200	660	630+450	1115	1 estante	3600	130	1,4	8.180€



STILE VCPKPV-2	+2°C	1200	660	630+970	1600	3 estante	1000	90	1,9	6.970€
STILE VCPKPCV 14-2	+14°C	1200	660	630+970	1600	3 estante	1000	110	1,9	7.665€
STILE VNPKDV-2	-18°C	1200	660	630+970	1600	3 estante	3600	130	1,9	9.395€

No incluyen revestimiento

El modelo 14-1 y 14-2 es especial para chocolates y bombones. Permite regular la humedad Frio ventilado controlado mediante termostato electrónico de alta precisión.

Cristal templado e iluminación por led. Puertas abatibles neumáticas. Estructura en acero inox 304 Evaporador tratado con pintura atóxica y aislamiento de poliuretano ecológico, densidad 42 kg/m3 Voltaje: 230 F+N



SHOW SACP 6-P	+2°C	600	650	540+1300	1840	5 estante	600	140		3.820€
SHOW SACP 6-C (*)	+14°C	600	650	540+1300	1840	5 estante	600	140		4.280€
SHOW SACP 6-G Estático	-25°C	600	650	540+1300	1840	5 estante	1000	150		4.815€
SHOW SACP 6-D	-20°C	600	650	540+1300	1840	5 estante	1200	150		5.410€
SHOW ACP KPV-1	+2°C	810	650	540+1300	1840	5 estante	600	150		4.140€
SHOW ACP KCV14-1 (*)	+14°C	810	650	540+1300	1840	5 estante	600	150		4.740€
SHOW ANP KGE-1 Estático	-25°C	810	650	540+1300	1840	5 estante	1000	160		5.245€
SHOW AMP KDV-1	-20°C	810	650	540+1300	1840	5 estante	1200	160		5.890€

Los modelos (*) 6-C y 14-1 son especiales para chocolates y permite regular la humedad

Frio ventilado en todos los modelos excepto ANPKGE-1 y SACP 6-G

Cristal templado e iluminación por led. Estructura en acero inox 304

Evaporador tratado con pintura atóxica y aislamiento de poliuretano ecológico, densidad 42 kg/m3 Voltaje: 230 F+N



Composición: LUXURY GEL

10.

VITRINA EXPOSITORA CON RESERVA PARA PASTERÍA

PASTRY DISPLAY CASE WITH STORAGE



- Encimera de trabajo en acero inox AISI 304
- Cristal curvo securizado abatible
- Bancada en acero esmaltado
- Claro de puerta de acceso media reserva 430x230
- Decoración y costado en DM hidrófugo lacado
- Decoración inferior en acero inox AISI 304
- Plano superior en acero inox AISI 304

- Decoración frontal con iluminación LED
- Plano de exposición en acero inox AISI 304
- Iluminación LED plano de exposición
- Iluminación LED estante
- Estantes en perfil de aluminio anodizado
- Modelos neutros [N]

VITRINAS PASTELERÍA PASTRY DISPLAY CASES

SERIE GLACE SERIES



- AISI 304 stainless steel worktop
- Front opening curved tempered security glass system
- Enamelled steel base
- Storage door opening 430x230
- Water resistant frontal and decoration DM lacqued
- AISI 304 stainless steel lower part decoration
- AISI 304 stainless steel upper surface

- LED lighting frontal decoration
- AISI 304 exhibition area
- Upper profile LED lighting
- LED lighting shelf
- Anodized aluminium profile shelves
- Neutral models [N]

VITRINA EXPOSITORA CON RESERVA PARA PASTERÍA

PASTRY DISPLAY CASE WITH STORAGE



VGL 15 C

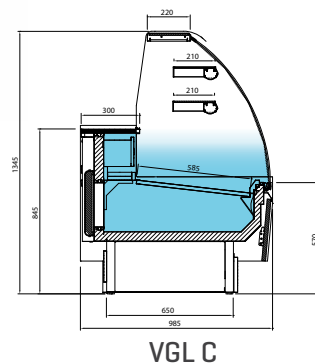

VGL C

MOD.	Costados Sides (mm)	Potencia Power (W)	Tensión Frecuencia Electrical (V/Hz)	Capacidad Capacity (L)	Nº puertas Doors	Superficie exposición (m2)	Estantes Shelving	Compresor Compressor (HP)	LED	Consumo Consumption (kWh/24h)	Evaporación Evaporation	Régimen TRA [25°C]	Potencia frigorífica Cooling capacity (W a -10°C)	Desescarche Defrost	Control	Refrigerante Coolant	De serie Standard
VGL 9 C	30+30	345	230/50	163	1	0,9	2	1/4	✓	6,1	Semi Estática Semi Static	+4°C/+8°C	353	Manual	Digital	R 134a	Luz estantes y decoración
VGL 12 C	30+30	442	230/50	217	2	1,2	2	1/3	✓	7,1	Semi Estática Semi Static	+4°C/+8°C	414	Manual	Digital	R 134a	Luz estantes y decoración
VGL 15 C	30+30	560	230/50	271	2	1,5	2	1/4	✓	9,0	Semi Estática Semi Static	+4°C/+8°C	464	Manual	Digital	R 134a	Luz estantes y decoración
VGL 18 C	30+30	580	230/50	327	3	2,0	2	1/2	✓	9,3	Semi Estática Semi Static	+4°C/+8°C	568	Manual	Digital	R 134a	Luz estantes y decoración
VGL 25 C	30+30	670	230/50	430	4	2,6	2	5/8	✓	10,5	Semi Estática Semi Static	+4°C/+8°C	684	Manual	Digital	R 134a	Luz estantes y decoración

SERIE GLACE SERIES



VGL 25 C

OPCIONAL OPTIONAL

- **Puertas correderas traseras** Rear sliding doors:

- VGL 9 (PUEVGL9T) 98 €
- VGL 12 (PUEVGL12T) 121 €
- VGL 15 (PUEVGL15T) 145 €
- VGL 18 (PUEVGL18T) 196 €
- VGL 25 (PUEVGL25T) 244 €

VGL 9 C

2.045€

938x985x1345 mm

C. Clima. 3
(+25°C 55%HR)



VGL 9 CN

1.725€

VGL 12 C

2.420 €

1250x985x1345 mm

C. Clima. 3
(+25°C 55%HR)



VGL 12 CN

2.100 €

VGL 15 C

2.730 €

1562x985x1345 mm

C. Clima. 3
(+25°C 55%HR)



VGL 15 CN

2.410 €

VGL 18 C

3.054€

1875x985x1345 mm

C. Clima. 3
(+25°C 55%HR)

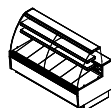

VGL 18 CN

2.537€

VGL 25 C

3.627€

2500x985x1345 mm

C. Clima. 3
(+25°C 55%HR)

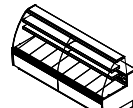

VGL 25 CN

3.045€

VITRINA EXPOSITORA CON RESERVA PARA PASTERÍA

PASTRY DISPLAY CASE WITH STORAGE



VGL 15 P

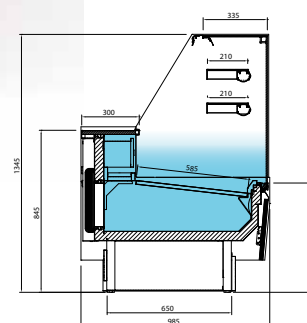

VGL P

MOD.	Costados Sides (mm)	Potencia Power (W)	Tensión Frecuencia Electrical (V/Hz)	Capacidad Capacity (L)	N° puertas Doors	Superficie exposición (m2)	Estantes Shelving	Compresor Compressor (HP)	LED	Consumo Consumption (kWh/24h)	Evaporación Evaporation	Régimen TRA (25°C)	Potencia frigorífica Cooling capacity (W a -10°C)	Desescarche Defrost	Control	Refrigerante Coolant	De serie Standard
VGL 9 P	30+30	345	230/50	163	1	0,9	2	1/4	✓	6,1	Semi Estática Semi Static	+4°C/+8°C	353	Manual	Digital	R 134a	Luz estantes y decoración
VGL 12 P	30+30	442	230/50	217	2	1,2	2	1/3	✓	7,1	Semi Estática Semi Static	+4°C/+8°C	414	Manual	Digital	R 134a	Luz estantes y decoración
VGL 15 P	30+30	560	230/50	271	2	1,5	2	1/4	✓	9,0	Semi Estática Semi Static	+4°C/+8°C	464	Manual	Digital	R 134a	Luz estantes y decoración
VGL 18 P	30+30	580	230/50	327	3	2,0	2	1/2	✓	9,3	Semi Estática Semi Static	+4°C/+8°C	568	Manual	Digital	R 134a	Luz estantes y decoración
VGL 25 P	30+30	670	230/50	430	4	2,6	2	5/8	✓	10,5	Semi Estática Semi Static	+4°C/+8°C	684	Manual	Digital	R 134a	Luz estantes y decoración

SERIE GLACE SERIES



VGL 25 P

OPCIONAL OPTIONAL

- **Puertas correderas traseras** Rear sliding doors:

- VGL 9 (PUEVGL9T) 98 €
- VGL 12 (PUEVGL12T) 121 €
- VGL 15 (PUEVGL15T) 145 €
- VGL 18 (PUEVGL18T) 196 €
- VGL 25 (PUEVGL25T) 244 €

VGL 9 P

2.061€

938x985x1345 mm

C. Clima. 3 [+25°C 55% HR]



VGL 9 PN

1.740€

VGL 12 P

2.470 €

1250x985x1345 mm

C. Clima. 3 [+25°C 55% HR]



VGL 12 PN

2.140 €

VGL 15 P

2.790€

1562x985x1345 mm

C. Clima. 3 [+25°C 55% HR]



VGL 15 PN

2.490 €

VGL 18 P

3.083€

1875x985x1345 mm

C. Clima. 3 [+25°C 55% HR]

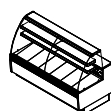

VGL 18 PN

2.566€

VGL 25 P

3.708€

2500x985x1345 mm

C. Clima. 3 [+25°C 55%HR]

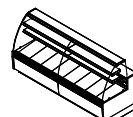

VGL 25 PN

3.127€

MUEBLE CAJA Y DECORACIONES

COUNTER CASE AND DECORATIONS



VGL 14 P + VGL 9 M



VGL 9 M

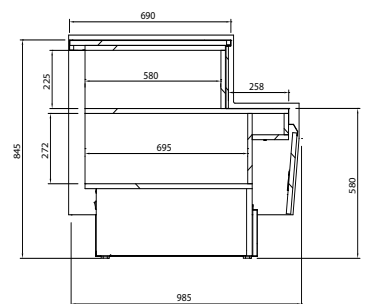

VGL M

VGL 9 M
1.244 €

VGL 14 M
1.510 €

VGL 90 AAM
2.100 €

VGL 14 ACM
2.300 €

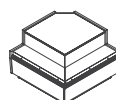

SERIE GLACE SERIES



VGL 14 M



RAL 3001

Rojo
Red



RAL 4007

Violeta
Violet



RAL 2003

Naranja
Orange



RAL 9017

Negro
Black



RAL 4007
Violeta
Violet



RAL 3003
Granate
MARoon



RAL 3020
Rojo
Red



Nogal
Walnut



RAL 2003
Naranja
Orange



RAL 1018
Amarillo
Yellow



RAL 1001
Beige
Beige



Wenge
Wenge



RAL 5015
Azul
Blue

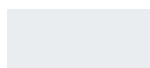

RAL 9016
Blanco
White



RAL 6002
Verde oscuro
Dark green



RAL 9017
Negro
Black



RAL DESIGN
3504035
Rosa
Pink



RAL DESIGN
2108025
Celeste
Sky blue



RAL DESIGN
1107060
Pistacho
Pistachio

VITRINA EXPOSICIONERA PARA PASTELERÍA

PASTRY DISPLAY CASE



- Encimera de trabajo en acero AISI 304
- Cristal recto securizado
- Decoración y costado en DM hidrófugo lacado
- Decoración inferior en acero inox AISI 304
- Plano de exposición en acero inox AISI 304
- Iluminación LED plano de exposición

- Poliuretano inyectado alta presión libre de CFC's densidad 40 kg/m3, bajo GWP y cero efecto ODP
- Sistema de condensación ventilada
- Control temperatura final del desescarche
- Bandeja evaporativa automática

VITRINAS PASTELERÍA PASTRY DISPLAY CASES

SERIE NIZA SERIES



- AISI 304 Stainless steel worktop
- Flat tempered security glass system
- Water resistant frontal and decoration lacqued MDF
- AISI 304 stainless steel lower part decoration
- AISI 304 exhibition area
- LED lighting exhibition area











- Free CFC's high density [40kg/m³] polyurethane insulation with low GWP & zero ODP effect
- Forced air refrigeration system
- Control of the final defrost temperature
- Automatic evaporative tray

VITRINA EXPOSITORA PARA PASTERÍA

PASTRY DISPLAY CASE



VNZ 15

MOD.	 Costados Sides (mm)	 Potencia Power (W)	 Tensión/Frecuencia Electrical [V/Hz]	 Superficie exposición (m2)	 Compresor Compressor (HP)	 LED	 Consumo Consumption (kWh/24h)	 Evaporación Evaporation	 Potencia frigorífica Cooling capacity [W a -10°C]	 Desescarche Defrost	 Control	 Refrigerante Coolant
VNZ9DT	20+20	750	230/50	0,60	1/4	✓	7#7,4	Forzada Forced	298	Automático Automatic	Digital	R 134 a
VNZ12DT	20+20	795	230/50	0,80	1/3	✓	5,8#9,9	Forzada Forced	395	Automático Automatic	Digital	R 134 a
VNZ15DT	20+20	870	230/50	1,00	3/8	✓	8,2#12,4	Forzada Forced	464	Automático Automatic	Digital	R 134 a
VNZ18DT	20+20	920	230/50	1,20	1/2	✓	9,3#14,8	Forzada Forced	568	Automático Automatic	Digital	R 134 a
VNZ9HT	20+20	380	230/50	0,60		✓	7,4	Forzada Forced		Automático Automatic	Digital	
VNZ12HT	20+20	510	230/50	0,80		✓	9,9	Forzada Forced		Automático Automatic	Digital	
VNZ15HT	20+20	635	230/50	1,00		✓	12,4	Forzada Forced		Automático Automatic	Digital	
VNZ18HT	20+20	760	230/50	1,20		✓	14,8	Forzada Forced		Automático Automatic	Digital	
VNZ9	20+20	750	230/50	0,60	1/4	✓	5,8	Forzada Forced	298	Automático Automatic	Digital	R 134 a
VNZ12	20+20	795	230/50	0,80	1/3	✓	7	Forzada Forced	395	Automático Automatic	Digital	R 134 a
VNZ15	20+20	870	230/50	1	3/8	✓	8,2	Forzada Forced	464	Automático Automatic	Digital	R 134 a
VNZ18	20+20	920	230/50	1,20	1/2	✓	9,3	Forzada Forced	568	Automático Automatic	Digital	R 134 a
VNZ12B	20+20	650	230/50	0,80	1/5	✓	6,1	Forzada Forced	254	Automático Automatic	Digital	R 134 a

SERIE NIZA SERIES



VNZ 12+ VNZ15

VNZ 9 DT

2.988 €

VNZ 9 HT

2.244 €

VNZ 9

2.339 €

938x 915x 1040 mm

Temp. +4°C/+8°C
C.Clima. 3

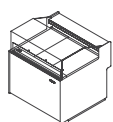

VNZ 12 DT

3.248 €

VNZ 12 HT

2.603 €

VNZ 12

2.618 €

1250x 915x 1040 mm

Temp. +4°C/+8°C
C.Clima. 3

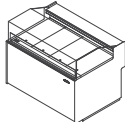

VNZ 15 DT

3.806 €

VNZ 15 HT

3.211 €

VNZ 15

2.920 €

1562x 915x 1040 mm

Temp. +4°C/+8°C
C.Clima. 3

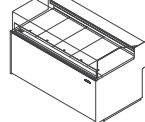

VNZ 18 DT

4.293 €

VNZ 18 HT

3.623 €

VNZ 18

3.237 €

1875x 915x 1040 mm

Temp. +4°C/+8°C
C.Clima. 3

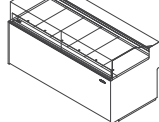

DT:

Doble temperatura
Double temperature

HT:

Vitrina caliente
Hot temperature

VNZ 12 B

2.761 €

1250x 915x 1040 mm

Temp. +7°C/+12°C
C.Clima. 3

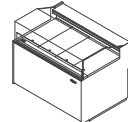

10.

VITRINA EXPOSITORA PARA PASTELERÍA

PASTRY DISPLAY CASE

VNZ90AAM



VNZ 12M



VNZ9M

1.513 €

938x 915x 740 mm

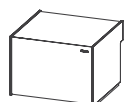

VNZ12M

1.690 €

1250x 915x 740 mm

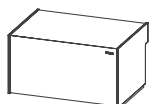

VNZ12MHD

1.810 €

1250x 915x 740 mm

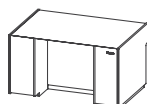

VNZ90AAM

2.447 €

1855x 915x 740 mm

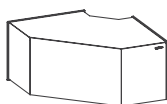

VNZ45AAM

1.358 €

1035x 915x 740 mm

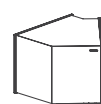

VNZ90ACM

1.781 €

2325x 915x 740 mm

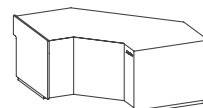

VNZ45ACM

1.383 €

1295x 915x 740 mm



DECORACIONES SERIE NIZA

DECORATIONS SERIES



VNZ 12



RAL 4007
Violeta
Violet



RAL 1018
Amarillo
Yellow



RAL 3003
Granate
MARoon



RAL 6002
Verde oscuro
Dark green



RAL 2003
Naranja
Orange

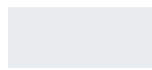

RAL 9016
Blanco
White



RAL 3020
Rojo
Red



RAL DESIGN
1107060
Pistacho
Pistachio



RAL 5015
Azul
Blue



RAL DESIGN
2108025
Celeste
Sky blue



RAL 1001
Beige
Beige



RAL 9017
Negro
Black



RAL DESIGN
3504035
Rosa
Pink

VITRINA EXPOSITORA PARA PASTERÍA PASTRY DISPLAY CASE



EXTERIOR

- Encimera de trabajo en compac quartz blanco
- Cristal recto securizado
- Decoración y costado en DM hidrófugo lacado
- Decoración inferior en acero inox AISI 304
- Decoración frontal con iluminación LED

INTERIOR

- Plano de exposición en acero inox AISI 304
- Iluminación LED plano de exposición
- Iluminación LED estante (OP)
- Estantes en perfil de aluminio anodizado [opcional]

REFRIGERACIÓN

- Sistema de condensación ventilada
- Control temperatura final del desescarche
- Bandeja evaporativa automática

SERIE LYON SERIES



EXTERIOR

- White compac quartz worktop
- Flat tempered security glass system
- Water resistant frontal and decoration lacqued MDF
- AISI 304 stainless steel lower part decoration
- LED lighting frontal decoration

INTERIOR

- AISI 304 exhibition area
- Upper profile LED lighting
- LED lighting shelf [OP]
- Anodized aluminium profile shelves [optional]

REFRIGERATION

- Forced air refrigeration system
- Control of the final defrost temperature
- Automatic evaporative tray

VITRINA EXPOSITORA PARA PASTERÍA

PASTRY DISPLAY CASE

Estante opcional
Optional shelf



VLY 15

MOD.



Costados
Sides
(mm)



Potencia
Power
(W)



Tensión Frecuencia
Electrical
(V/Hz)



Bandejas
Trays
(300x400)



Bandejas
Trays
(600x400)



Superficie
exposición
(m²)



Estantes
Shelving



Compresor
Compressor
(HP)



LED



Consumo
Consumption
(kWh/24h)



Evaporación
Evaporation



Potencia frigorífica
Cooling capacity
(W a -10°C)



Desescarche
Defrost



Control



Refrige-
rante
Coolant

MOD.	Costados Sides (mm)	Potencia Power (W)	Tensión Frecuencia Electrical (V/Hz)	Bandejas Trays (300x400)	Bandejas Trays (600x400)	Superficie exposición (m ²)	Estantes Shelving	Compresor Compressor (HP)	LED	Consumo Consumption (kWh/24h)	Evaporación Evaporation	Potencia frigorífica Cooling capacity (W a -10°C)	Desescarche Defrost	Control	Refrige- rante Coolant
VLY9	30+30	750	230/50	4	2	0,60	1 OPC.	1/4	✓	5,8	Forzada Forced	298	Automático Automatic	Digital	R 134 a
VLY12	30+30	795	230/50	6	3	0,80	1 OPC.	1/3	✓	7	Forzada Forced	395	Automático Automatic	Digital	R 134 a
VLY15	30+30	870	230/50	6	3	1,00	1 OPC.	3/8	✓	8,2	Forzada Forced	464	Automático Automatic	Digital	R 134 a
VLY18	30+30	920	230/50	8	4	1,20	1 OPC.	1/2	✓	9,3	Forzada Forced	568	Automático Automatic	Digital	R 134 a
VLY25	30+30	1010	230/50	12	6	1,60	1 OPC.	5/8	✓	11,2	Forzada Forced	684	Automático Automatic	Digital	R 134 a

SERIE LYON SERIES



VLY9

MOD.	Puertas correderas traseras Rear sliding doors
VLY 9	[PUEVLY9] 140
VLY 12	[PUEVLY12] 186
VLY 15	[PUEVLY15] 193

MOD.	Puertas correderas traseras Rear sliding doors
VLY 18	[PUEVLY18] 200
VLY 25	[PUEVLY26] 207

OPCIONES OPTIONS

- Estante Shelf

VLY 9 [ESTVCB9] 150 €
 VLY 12 [ESTVCB12] 170 €
 VLY 15 [ESTVCB15] 190 €
 VLY 18 [ESTVCB18] 265 €
 VLY 25 [ESTVCB25] 303 €

VLY9

2.703 €

938x 900x 1305 mm

Temp. +4°C/+8°C
 C. Clima. 3
 [25° 60%HR]



VLY12

3.060€

1250x 900x 1305 mm

Temp. +4°C/+8°C
 C. Clima. 3
 [25° 60%HR]



VLY15

3.512€

1562x 900x 1305 mm

Temp. +4°C/+8°C
 C. Clima. 3
 [25° 60%HR]

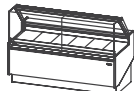

VLY18

3.959€

1875x 900x 1305 mm

Temp. +4°C/+8°C
 C. Clima. 3
 [25° 60%HR]

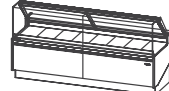

VLY25

4.616€

2500x 900x 1305 mm

Temp. +4°C/+8°C
 C. Clima. 3
 [25° 60%HR]

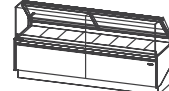



VITRINA EXPOSITORA PARA PASTELERÍA

PASTRY DISPLAY CASE



VLY9V

MOD.	 Costados Sides (mm)	 Potencia Power (W)	 Tensión Frecuencia Electrical (V/Hz)	 Bandejas Trays (300x400)	 Bandejas Trays (600x400)	 Superficie exposición (m ²)	 Estantes Shelving	 LED	 Consumo Consumption (kWh/24h)
VLY9 V	30+30	45	230/50	12	8	1,13	3	✓	0,6
VLY12 V	30+30	70	230/50	16	12	1,50	3	✓	1

VITRINAS PASTELERÍA PASTRY DISPLAY CASES
SERIE LYON VIENNOIS SERIE SERIES

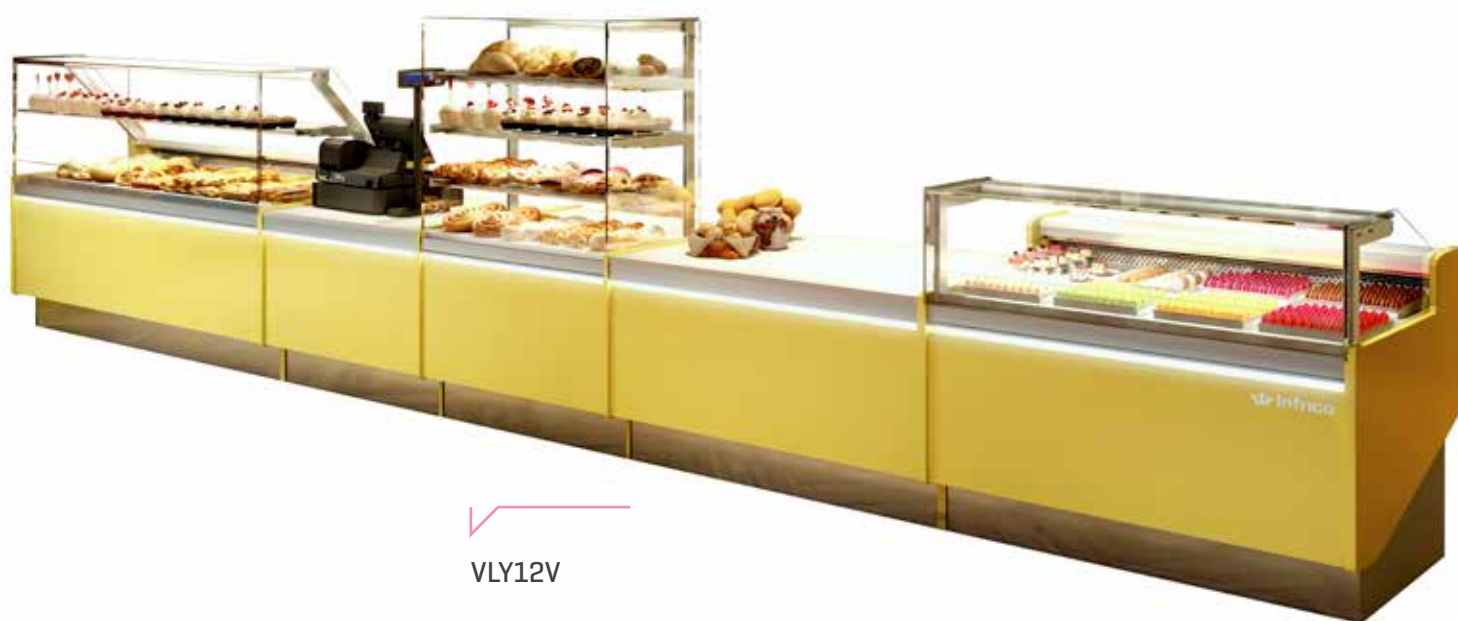

VLY12V

VLY9V

2.951€

938x 900x 1550 mm



VLY12V

3.370 €

1250x 900x 1550 mm



Puertas correderas traseras de serie
Rear sliding doors standard

VITRINA EXPOSITORA PARA PASTELERÍA

PASTRY DISPLAY CASE



VLY12B

VLY12B**3.117 €**

1250x 900x 1060 mm

Temp. +7°C/+12°C
C. Clima. 3 (25° 60%HR)**OPCIONES OPTIONS**- Puertas correderas traseras
Rear sliding doors

VLY 12 B (PUEVLY12CTB) 186 €

**MOD.**

	Costados Sides (mm)	Potencia Power (W)	Tensión Frecuencia Electrical (V/Hz)	Capacidad Capacity (L)	N° puertas Doors	Superficie exposición (m2)	Estantes Shelving	Compresor Compressor (HP)	LED	Consumo Consumption (kWh/24h)	Evaporación Evaporation	Potencia frigorífica Cooling capacity (W a -10°C)	Desescarche Defrost	Control	Refrigerante Coolant
VLY12 B	30+30	795	230/50	6	3	0,80	1 OPC.	1/5	✓	6,1	Forzada Forced	254	Automático Automatic	Digital	R 134 a



VITRINAS PASTELERÍA PASTRY DISPLAY CASES

SERIE LYON CHOCOLATE & LYON BAÑO MARÍA SERIES



VLY12BMS

VLY12BMS

2.996 €

1250x900x1305 mm

Temp. +60°C/+70°C

VLY15BMS

3.438 €

1562x900x1305 mm

Temp. +60°C/+70°C



MOD.

	Costados Sides (mm)	Potencia Power (W)	Tensión Frecuencia Electrical (V/Hz)	Bandejas Trays (600x400)	Superficie exposición (m2)	LED	Consumo Consumption (kWh/24h)	Control
VLY12BMS	30+30	2050	220/50	3	0,69	✓	12,3	Digital
VLY15BMS	30+30	3050	220/50	4	0,86	✓	18,3	Digital

10.

VITRINA EXPOSITORA PARA PASTERÍA VIDRIO BAJO PASTRY DISPLAY CASE LOW GLASS



VITRINAS PASTELERÍA PASTRY DISPLAY CASES

SERIE LYON LG SERIES



VITRINA EXPOSITORA PARA PASTERÍA VIDRIO BAJO PASTRY DISPLAY CASE LOW GLASS



VLY15 LG

MOD.	 Costados Sides (mm)	 Potencia Power (W)	 Tensión Frecuencia Electrical (V/Hz)	 Bandejas Trays (300x400)	 Bandejas Trays (600x400)	 Superficie exposición (m ²)	 Compresor Compressor (HP)	 LED	 Consumo Consumption (kWh/24h)	 Evaporación Evaporation	 Potencia frigorífica Cooling capacity (W a -10°C)	 Desescarche Defrost	 Control	 Refrigerante Coolant
VLY9 LG	30+30	750	230/50	4	2	0,60	1/4	✓	5,8	Forzada Forced	298	Automático Automatic	Digital	R 134 a
VLY12 LG	30+30	795	230/50	6	3	0,80	1/3	✓	7	Forzada Forced	395	Automático Automatic	Digital	R 134 a
VLY15 LG	30+30	870	230/50	6	3	1,00	3/8	✓	8,2	Forzada Forced	464	Automático Automatic	Digital	R 134 a
VLY18 LG	30+30	920	230/50	8	4	1,20	1/2	✓	9,3	Forzada Forced	568	Automático Automatic	Digital	R 134 a
VLY25 LG	30+30	1010	230/50	12	6	1,60	5/8	✓	11,2	Forzada Forced	684	Automático Automatic	Digital	R 134 a

SERIE LYON LG SERIES



VLY12 LG

VLY9 LG

2.666 €

938x 900x 1060 mm

Temp. +4°C/+8°C
C. Clima. 3 [25° 60%HR]



VLY12 LG

3.010 €

1250x 900x 1060 mm

Temp. +4°C/+8°C
C. Clima. 3 [25° 60%HR]



VLY15 LG

3.444 €

1562x 900x 1060 mm

Temp. +4°C/+8°C
C. Clima. 3 [25° 60%HR]



VLY18 LG

3.899 €

1875x 900x 1060 mm

Temp. +4°C/+8°C
C. Clima. 3 [25° 60%HR]



VLY25 LG

4.525 €

2500x 900x 1060 mm

Temp. +4°C/+8°C
C. Clima. 3 [25° 60%HR]



10.

MUEBLE CAJA COUNTER CASE



VLY9M



VLY 12 MHD
HANDICAPÉ

VLY9M

1.552€

938x 900x 745 mm



VLY12M

1.757€

1250x900x745 mm



VLY12MHD

1.936€

1250x900x745 mm

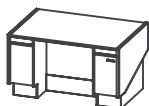

VLY90AAM

1.864€

1855x900x745 mm



VLY45AAM

1.520€

1035x900x745 mm



VLY90ACM

2.467€

2325x900x745 mm

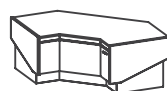

VLY45ACM

1.774€

1295x900x745 mm



VITRINAS PASTELERÍA PASTRY DISPLAY CASES

DECORACIONES SERIE LYON

DECORATIONS SERIES



VLY9
RAL 1018
Amarillo / Yellow



VLY9
RAL 3504035
Rosa / Pink



VLY9
RAL 1001
Beige



VLY9
RAL 9016
Blanco / White



RAL 4007
Violeta
Violet



RAL 1018
Amarillo
Yellow



RAL 3003
Granate
Maroon



RAL 6002
Verde oscuro
Dark green



RAL 2003
Naranja
Orange



RAL 9016
Blanco
White



RAL 3020
Rojo
Red



RAL DESIGN
1107060
Pistacho
Pistachio



RAL 5015
Azul
Blue



RAL DESIGN
2108025
Celeste
Sky blue



RAL 1001
Beige
Beige



RAL 9017
Negro
Black



RAL DESIGN
3504035
Rosa
Pink

VITRINA EXPOSITORA PARA PASTERÍA

PASTRY DISPLAY CASE



- Encimera superior en acero inox AISI 304
- Cristal frontal curvo securizado abatible
- Cristal costado lateral doble
- Bancada en acero esmaltado
- Decoración en DM hidrófugo lacado
- Decoración frontal con iluminación LED
- Plano de exposición en acero inox AISI 304

- Iluminación LED plano de exposición
- Iluminación LED estantes
- Estantes en perfil de aluminio anodizado
- Puertas correderas traseras dobles
- Sistema de condensación ventilada
- Bandeja evaporativa doble
- Control temperatura final del desescarche

VITRINAS PASTELERÍA PASTRY DISPLAY CASES

SERIE AMBAR SERIES



- AISI 304 stainless steel upper worktop
- Frontal opening curved tempered security glass system
- Double lateral glass sides
- Enamelled steel base
- Water resistant frontal and decoration DM lacqued
- LED lighting frontal decoration
- AISI 304 exhibition area

- Upper profile LED lighting
- LED lighting shelves
- Anodized aluminium profile shelves
- Double rear sliding doors
- Forced air refrigeration system
- Stainless steel evaporative double
- Control of the final defrost temperature

10.

















VITRINA EXPOSITORA PARA PASTERÍA

PASTRY DISPLAY CASE



VBR 12 R

MOD.

	 Costados Sides (mm)	 Potencia Power (W)	 Tensión Electrical (V/Hz)	 Capacidad Capacity (L)	 N° puertas Doors	 Superficie exposición (m2)	 Estantes Shelving	 Compresor Compressor (HP)	 LED	 Consumo Consumption (kWh/24h)	 Evaporación Evaporation	 Régimen Temp. (30°C)	 Potencia frigorífica Cooling capacity (W a -10°C)	 Desescarche Defrost	 Control	 Refrigerante Coolant
--	---	--	---	--	--	--	---	---	---	---	---	--	---	---	---	--

VBR 9 R	20+20	1000	230/50	274	2	1,4	3	1/2	✓	16,0	Forzada Forged	+4°C/+8°C	1096	Automático Automatic	Digital	R-452
VBR 12 R	20+20	1060	230/50	365	2	1,9	3	3/4	✓	17,0	Forzada Forged	+4°C/+8°C	1315	Automático Automatic	Digital	R-452
VBR 18 R	20+20	1340	230/50	548	3	2,8	3	1	✓	21,4	Forzada Forged	+4°C/+8°C	1840	Automático Automatic	Digital	R-452

SERIE AMBAR SERIES



VBR 9 R



VBR 12 R



RAL 9016
Blanco
White



RAL 9017
Negro
Black



RAL 3001
Rojo
Red



RAL 5015
Azul
Blue

VBR 9 R

3.403 €

938x810x1300 mm

C. Clima. 4
[+30°C 55%HR]



VBR 12 R

3.756 €

1250x810x1300 mm

C. Clima. 4
[+30°C 55%HR]



VBR 18 R

4.763€

1875x810x1300 mm

C. Clima. 4
[+30°C 55%HR]

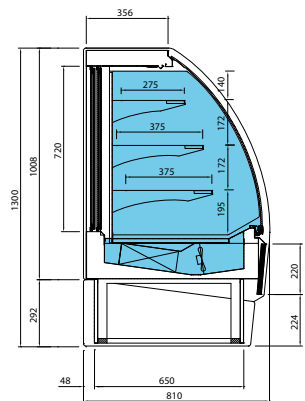

VBR R

OPCIONES OPTIONS

- **Cristal frontal doble**
Double front glass
- VBR 9 213 € *
- VBR 12 234 € *
- VBR 18 427 € *

*

Este precio es aplicable cuando el cristal va incorporado en el mueble











This price is applicable when the glass is incorporated with the display case

VITRINA CALIENTE EXPOSITORA PARA PASTELERÍA

PASTRY HOT DISPLAY CASE



MOD.

	 Costados Sides (mm)	 Potencia Power (W)	 Tensión Frecuencia Electrical (V/Hz)	 Capacidad Capacity (L)	 N° puertas Doors	 Superficie exposición (m ²)	 Estantes Shelving	 LED	 Consumo Consumption (kWh/24h)	 Control
--	---	--	--	--	---	---	--	---	---	---

VBR 9 HT	20+20	570	230/50	274	2	1	2	✓	6,8	Digital
VBR 12 HT	20+20	830	230/50	365	2	1,4	2	✓	10,0	Digital
VBR 18 HT	20+20	1100	230/50	548	3	2,1	2	✓	13,2	Digital

VITRINAS PASTELERÍA PASTRY DISPLAY CASES

SERIE AMBAR SERIES



VBR 12 HT

VBR 9 HT

3.043 €

938x810x1300 mm

Temp. +55°/+60°C



VBR 12 HT

3.354 €

1250x810x1300 mm

Temp. +55°/+60°C



VBR 18 HT

4.256 €

1875x810x1300 mm

Temp. +55°/+60°C

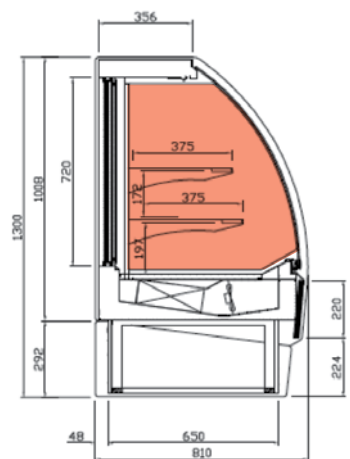

VBR HT

VITRINA EXPOSITORA PARA PASTELERÍA

PASTRY DISPLAY CASE



VBR 12 SS

MOD.

	Costados Sides (mm)	Potencia Power (W)	Tensión Frecuencia Electrical (V/Hz)	Capacidad Capacity (L)	Nº puertas Doors	Superficie exposición (m ²)	Estantes Shelving	Compresor Compressor (HP)	LED	Consumo Consumption (kWh/24h)	Evapora- ción Evapora- tion	Régimen Temp. (30°C)	Potencia frigorífica Cooling capacity (W a -10°C)	Desescarche Defrost	Control	Refrige- rante Coolant	De serie Standard

VBR 6 SS	20+20	825	230/50	180	-	0,9	3	1/3	✓	18,2	Forzada Forced	+4°C/+8°C	750	Automático Automatic	Digital	R-452	Cortina nocturna Night curtain
VBR 9 SS	20+20	1000	230/50	274	-	1,4	3	1/2	✓	20,0	Forzada Forced	+4°C/+8°C	1096	Automático Automatic	Digital	R-452	Cortina nocturna Night curtain
VBR 12 SS	20+20	1060	230/50	365	-	1,9	3	3/4	✓	21,2	Forzada Forced	+4°C/+8°C	1315	Automático Automatic	Digital	R-452	Cortina nocturna Night curtain
VBR 18 SS	20+20	1340	230/50	548	-	2,8	3	1	✓	26,8	Forzada Forced	+4°C/+8°C	1840	Automático Automatic	Digital	R-452	Cortina nocturna Night curtain

SERIE AMBAR SERIES



VBR 6 SS



Cortina nocturna
Nigth curtain

VBR 6 SS

3.022 €

938x810x1300 mm

C. Clima. 3 [+25°C 60%HR]



VBR 9 SS

3.332 €

938x810x1300 mm

C. Clima. 3 [+25°C 60%HR]



VBR 12 SS

3.719 €

1250x810x1300 mm

C. Clima. 3 [+25°C 60%HR]



VBR 18 SS

4.702 €

1875x810x1300 mm

C. Clima. 3 [+25°C 60%HR]

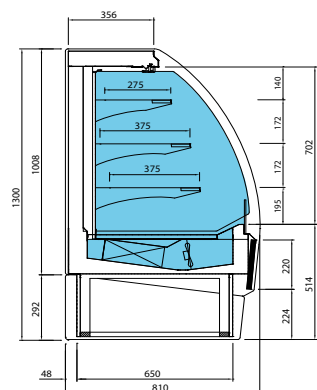

VBR SS

VITRINA EXPOSITORA PARA PASTERÍA DE DOBLE SERVICIO

DOUBLE SERVICE PASTRY DISPLAY CASE



VBR 12 DS

VBR 9 DS**3.517 €**

938x810x1300 mm

C. Clima. 3 [+25°C 60%HR]

VBR 12**3.924 €**

1250x810x1300 mm

C. Clima. 3 [+25°C 60%HR]

VBR 18 DS**6.125 €**

1875x810x1300 mm

C. Clima.3 [+25°C 60%HR]

**MOD.**

|--|--|--|--|--|--|--|--|--|--|--|--|--|--|--|--|--|--|

VBR 9 DS	20+20	1000	230/50	274	2	1,4	3	1/2	✓	20,0	Forzada Forced	+4°C/+8°C	1096	Automático Automatic	Digital	R-452	Cortina nocturna Night curtain
VBR 12 DS	20+20	1060	230/50	365	2	1,9	3	3/4	✓	21,2	Forzada Forced	+4°C/+8°C	1315	Automático Automatic	Digital	R-452	Cortina nocturna Night curtain
VBR 18 DS	20+20	1640	230/50	548	4	2,8	3	1/2+1/2	✓	36,8	Forzada Forced	+4°C/+8°C	2192	Automático Automatic	Digital	R-452	Cortina nocturna Night curtain

SERIE AMBAR SERIES



RAL 4007
Violeta
Violet



RAL 3003
Granate
MAroon



RAL 3020
Rojo
Red



Nogal
Walnut



RAL 2003
Naranja
Orange



RAL 1018
Amarillo
Yellow



RAL 1001
Beige
Beige



Wenge
Wenge



RAL 5015
Azul
Blue

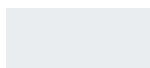

RAL 9016
Blanco
White



RAL 6002
Verde oscuro
Dark Green



RAL 9017
Negro
Black



RAL DESIGN
3504035
Rosa
Pink



RAL DESIGN
2108025
Celeste
Sky blue



RAL DESIGN
1107060
Pistacho
Pistachio

VITRINA EXPOSITORA PARA PASTERÍA

PASTRY DISPLAY CASE



- Chapa prelacada,
- Plano de exposición en EPOXI,
- Decoración en DM hidrófugo lacado,
- Cristal frontal templado abatible,
- Puertas correderas traseras,
- Cristales laterales dobles.
- Estante superior neutro

- Cortina nocturna
- Bancada en Acero esmaltado,
- Plano de exposición y estantes iluminados mediante LED,
- Perfiles en aluminio anodizado,
- Temperatura regulada por un controlador digital y desescarche automático,

- Termostato electrónico trasero,
- Sistema de Condensación Ventilada,
- Sistema de Evaporación Forzada,
- Bandeja evaporativa en acero inoxidable con doble cuba.
- Clase climática 3 [25°C, 55%HR].

VITRINAS PASTELERÍA PASTRY DISPLAY CASES

SERIE COMBO SERIES



- Laminated steel plate,
- Exhibition area in EPOXI,
- Decoration DM lacqued,
- Hinged front tempered glass,
- Rear sliding doors,
- Double lateral glass sides,
- Dry countertop

- Night curtain
- Enamelled steel base,
- LED lighting in the front,
- LED lighting in canopy and under each shelf
- Digital temperature controller with automatic defrost system,
- Rear electronic thermostat,

- Forced air refrigeration system,
- Stainless Steel Evaporative double trays.
- Refrigerant gas R404A,
- Case engineered to operate at 75°F and 55% relative humidity.

VITRINA EXPOSITORA PARA PASTERÍA

PASTRY DISPLAY CASE











Parte superior neutra
Neutral countertop

Separador opcional
Optional divider



VC015

MOD.

	 Costados Sides (mm)	 Potencia Power (W)	 Tensión Frecuencia Electrical (V/Hz)	 Capacidad Capacity (L)	 Estantes Shelving	 Compresor Compressor (HP)	 LED	 Evaporación Evaporation	 Control	 Refrigerante Coolant	 De serie Standard
VC09	30+30	1.000	230/50	201	1	5/8	✓	Forzada Forced	Digital	R-452	Cortina nocturna Night curtain
VC012	30+30	1.060	230/50	268	1	3/4	✓	Forzada Forced	Digital	R-452	Cortina nocturna Night curtain
VC015	30+30	1.340	230/50	334	1	7/8	✓	Forzada Forced	Digital	R-452	Cortina nocturna Night curtain
VC018	30+30	1.640	230/50	401	1	1	✓	Forzada Forced	Digital	R-452	Cortina nocturna Night curtain

SERIE COMBO SERIES



VC015

VC09

4.014 €

938x810x1455 mm
Temp. +2°C/+5 °C
C. Clima 3



VC012

4.368 €

1250x810x1455 mm
Temp. +2°C/+5 °C
C. Clima 3



VC0 15

4.902 €

1562x810x1455 mm
Temp. +2°C/+5 °C
C. Clima 3

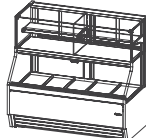

VC0 18

5.156 €

1875x810x1455 mm
Temp. +2°C/+5 °C
C. Clima 3

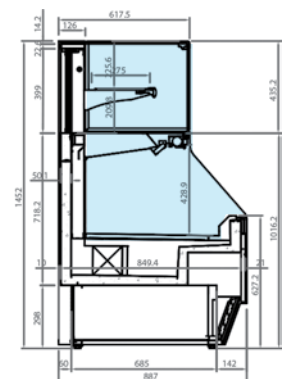
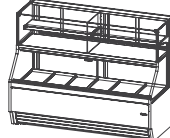

10.

VITRINA EXPOSITORA PARA PASTERÍA PASTRY DISPLAY CASE



EXTERIOR

- Encimera superior en acero inox AISI 304
- Acero inox AISI 304
- Cristal costado lateral doble
- Vidrio frontal recto calefactado
- Bancada en acero esmaltado
- Iluminación LED frontal

INTERIOR

- Plano de exposición en acero inox AISI 304
- Iluminación LED plano de exposición
- Iluminación LED estantes

REFRIGERACIÓN

- Sistema de condensación ventilada
- Bandeja evaporativa doble
- Control temperatura final del desescarche
- Clase climática 4

SERIE ONIX SERIES



EXTERIOR

- AISI 304 stainless steel upper worktop
- AISI 304 stainless steel
- Double lateral glass sides
- Straight frontal tempered glass
- Enamelled steel base
- LED lighting frontal decoration

INTERIOR

- AISI 304 exhibition area
- Upper profile LED lighting
- LED lighting shelves

REFRIGERATION

- Forced air refrigeration system
- Stainless steel evaporative double
- Control of the final defrost temperature
- Climatic class 4

VITRINA EXPOSITORA PARA PASTERÍA

PASTRY DISPLAY CASE



VON12PR

MOD.	 Costados Sides (mm)	 Potencia Power (W)	 Tensión Frecuencia Electrical (V/Hz)	 Capacidad Capacity (L)	 N° puertas Doors	 Superficie exposición (m2)	 Estantes Shelving	 Compresor Compressor (HP)	 LED	 Consumo Consumption (kWh/24h)	 Evaporación Evaporation	 Potencia frigorífica Cooling capacity (W a -10°C)	 Desescarche Defrost	 Control	 Refrigerante Coolant
VON9PR	20+20	1000	230/50	274	2	1,4	3	1/2	✓	16,00	Forzada Forced	1096	Automático Automatic	Digital	R-452
VON12PR	20+20	1060	230/50	365	2	1,9	3	3/4	✓	17,0	Forzada Forced	1315	Automático Automatic	Digital	R-452
VON18PR	20+20	1340	230/50	548	3	2,8	3	1	✓	21,4	Forzada Forced	1840	Automático Automatic	Digital	R-452
VON9PHT	20+20	570	230/50	274	2	1,0	2	-	✓	6,8	-	-	-	Digital	-
VON12PHT	20+20	830	230/50	365	2	1,4	2	-	✓	10,0	-	-	-	Digital	-
VON18PHT	20+20	1100	230/50	548	3	2,1	2	-	✓	13,2	-	-	-	Digital	-

SERIE ONIX SERIES

VON12PR

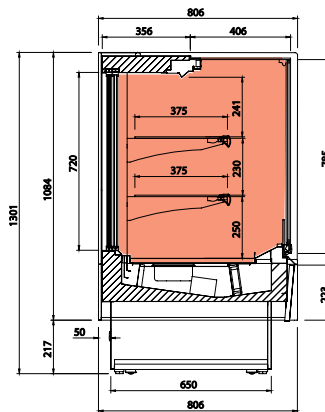
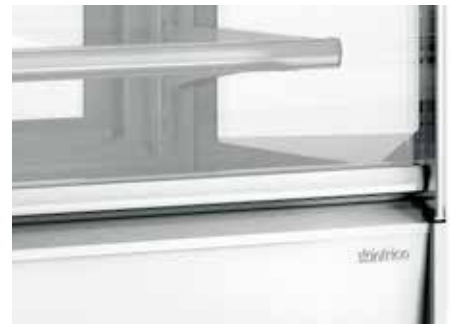

VONPHT

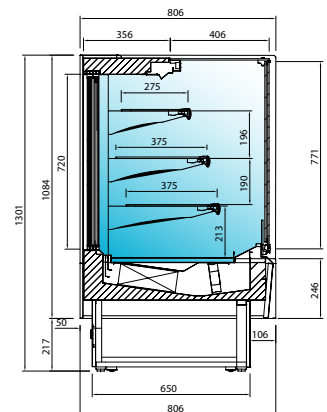

VON12PR

VON9PR

3.820 €

938x810x1300 mm

Temp. +4°C/+8°C
C. Clima. 4



VON12PR

4.231 €

1250x810x1300 mm

Temp. +4°C/+8°C
C. Clima. 4



VON18PR

5.308 €

1875x810x1300 mm

Temp. +4°C/+8°C
C. Clima. 4

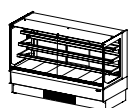

VON9PHT

3.286 €

938x810x1300 mm

Temp. +55°C/+65°C
C. Clima. 4

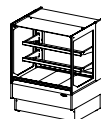

VON12PHT

3.605 €

1250x810x1300 mm

Temp. +55°C/+65°C
C. Clima. 4



VON18PHT

4.732 €

1875x810x1300 mm

Temp. +55°C/+65°C
C. Clima. 4



VITRINA EXPOSITORA PARA PASTERÍA

PASTRY DISPLAY CASE

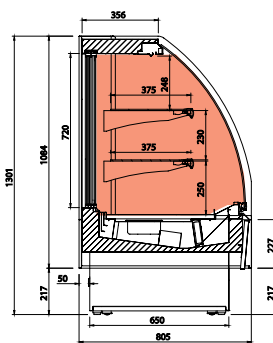

VON HT

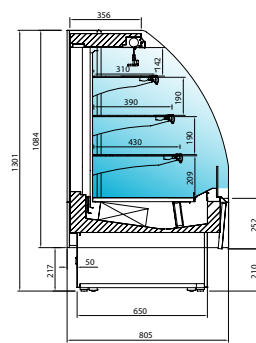

VON SS

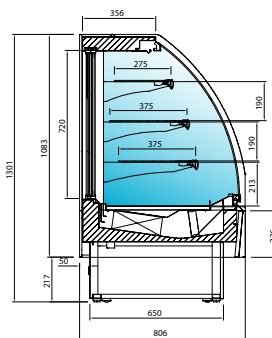

VON R

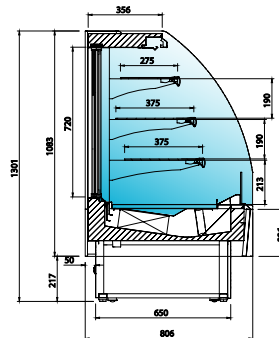

VON DS

VON6SS

MOD.

- Costados Sides (mm)
- Potencia Power (W)
- Tensión Frecuencia Electrical (V/Hz)
- Capacidad Capacity (L)
- N° puertas Doors
- Superficie exposición (m²)
- Estantes Shelving
- Compresor Compressor (HP)
- LED
- Consumo Consumption (kWh/24h)
- Evaporación Evaporation
- Potencia frigorífica Cooling capacity (W a -10°C)
- Desescarche Defrost
- Control
- Refrigerante Coolant

MOD.	Costados Sides (mm)	Potencia Power (W)	Tensión Frecuencia Electrical (V/Hz)	Capacidad Capacity (L)	N° puertas Doors	Superficie exposición (m ²)	Estantes Shelving	Compresor Compressor (HP)	LED	Consumo Consumption (kWh/24h)	Evaporación Evaporation	Potencia frigorífica Cooling capacity (W a -10°C)	Desescarche Defrost	Control	Refrigerante Coolant
VON 9R	20+20	1000	230/50	274	2	1,4	3	1/2	✓	16,0	Forzada Forced	1096	Automático Automatic	Digital	R-452
VON 12R	20+20	1060	230/50	365	2	1,9	3	3/4	✓	17,0	Forzada Forced	1315	Automático Automatic	Digital	R-452
VON 18R	20+20	1340	230/50	548	3	2,8	3	1	✓	21,4	Forzada Forced	1840	Automático Automatic	Digital	R-452
VON 6SS	20+20	825	230/50	180	-	0,9	3	1/3	✓	18,2	Forzada Forced	750	Automático Automatic	Digital	R-452
VON 9SS	20+20	1000	230/50	274	-	1,4	3	1/2	✓	21,2	Forzada Forced	196	Automático Automatic	Digital	R-452
VON 12SS	20+20	1060	230/50	365	-	1,9	3	3/4	✓	26,8	Forzada Forced	1315	Automático Automatic	Digital	R-452
VON 18SS	20+20	1340	230/50	548	-	2,8	3	1	✓	18,2	Forzada Forced	1840	Automático Automatic	Digital	R-452
VON 9DS	20+20	1000	230/50	274	2	1,4	3	1/2	✓	20,0	Forzada Forced	1096	Automático Automatic	Digital	R-452
VON 12DS	20+20	1060	230/50	365	2	1,9	3	3/4	✓	21,2	Forzada Forced	1315	Automático Automatic	Digital	R-452
VON 18DS	20+20	1340	230/50	548	4	2,8	3	1/2+1/2	✓	6,8	Forzada Forced	2192	Automático Automatic	Digital	R-452
VON 9HT	20+20	570	230/50	274	2	1,0	2	-	✓	20,0	-	-	-	Digital	-
VON 12HT	20+20	830	230/50	365	2	1,4	2	-	✓	21,2	-	-	-	Digital	-
VON 18HT	20+20	1100	230/50	548	3	2,1	2	-	✓	36,8	-	-	-	Digital	-

SERIE ONIX SERIES

OPCIONAL OPTIONAL
Cristal frontal doble
Double frontal glass



VON9R

VON 9R

3.551 €

938x810x1300 mm

Temp. +4°C/+8°C



VON 12R

3.923 €

1250x810x1300 mm

Temp. +4°C/+8°C



VON 18R

4.857 €

1875x810x1300 mm

Temp. +4°C/+8°C

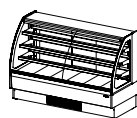

VON 6SS

3.025€

625x810x1300 mm

Temp. +4°C/+8°C



VON 9SS

3.429 €

938x810x1300 mm

Temp. +4°C/+8°C



VON 12SS

3.812 €

1250x810x1300 mm

Temp. +4°C/+8°C

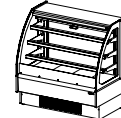

VON 18SS

4.855 €

1875x810x1300 mm

Temp. +4°C/+8°C

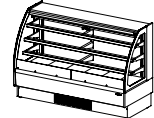

VON 9DS

3.595 €

938x810x1300 mm

Temp. +4°C/+8°C



VON 12DS

4.009 €

1250x810x1300 mm

Temp. +4°C/+8°C



VON 18DS

6.318 €

1875x810x1300 mm

Temp. +4°C/+8°C

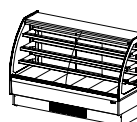

VON 9HT

3.117 €

938x810x1300 mm

Temp. +55°C/+65°C



VON 12HT

3.405 €

1250x810x1300 mm

Temp. +55°C/+65°C



VON 18HT

4.429 €

1875x810x1300 mm

Temp. +55°C/+65°C

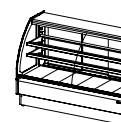

10.

VITRINA EXPOSITORA FRIO VENTILADO MODULAR PARA PASTERÍA CON RESERVA

REFRIGERATED MODULAR PASTRY DISPLAY CASE WITH STORAGE



- Encimera de trabajo en compac quartz blanco
- Cristal recto frontal y costado securizado
- Bancada en acero esmaltado
- Decoración en DM hidrófugo lacado
- Respaldo trasero en chapa plastificada
- Decoración frontal con iluminación LED
- Plano de exposición en acero tratado epoxi poliéster

- Iluminación LED plano de exposición
- Iluminación LED estantes
- Estructura soporte cristales en perfil de aluminio anodizado
- Sistema de condensación ventilada
- Bandeja evaporativa doble
- Control temperatura final del desescarche

VITRINAS PASTELERÍA PASTRY DISPLAY CASES

SERIE MAGNUS SERIES



- White compac quartz worktop
- Flat front and sides tempered security glass system
- Enamelled steel base
- Water resistant frontal and decoration DM lacqued
- Stainless steel plastified rear panel
- LED lighting frontal decoration
- Epoxi polyester steel coated exhibition area

- Upper profile LED lighting
- LED lighting shelves
- Anodized aluminium profile glass support structure
- Forced air refrigeration system
- Stainless steel evaporative double
- Control of the final defrost temperatura













VITRINA EXPOSITORA FRIO VENTILADO MODULAR PARA PASTELERÍA CON RESERVA

REFRIGERATED MODULAR PASTRY DISPLAY CASE WITH STORAGE



VMG 12 R

MOD.

	 Costados Sides (mm)	 Potencia Power (W)	 Tensión Frecuencia Electrical (V/Hz)	 Capacidad Capacity (L)	 N° puertas Doors	 Superficie exposición (m2)	 Estantes Shelving	 Compresor Compressor (HP)	 LED	 Consumo Consumption (kWh/24h)	 Evapora- ción Evaporation	 Potencia frigorífica Cooling capacity (W a -10°C)	 Desescarche Defrost	 Control	 Refrigerante Coolant
VMG 9 R	60+60	738	230/50	103	1	0,6	2	3/8	✓	11,8	Forzada Forced	676	Automático Automatic	Digital	R-452
VMG 12 R	60+60	988	230/50	138	2	0,8	2	5/8	✓	15,8	Forzada Forced	1096	Automático Automatic	Digital	R-452
VMG 12 B	60+60	738	230/50	138	-	0,8	2	3/8	✓	11,8	Forzada Forced	676	Automático Automatic	Digital	R-452
VMG 15 R	60+60	988	230/50	172	2	0,9	2	3/4	✓	17,1	Forzada Forced	1315	Automático Automatic	Digital	R-452
VMG 18 R	60+60	1263	230/50	206	3	1,1	2	1	✓	20,2	Forzada Forced	1506	Automático Automatic	Digital	R-452
VMG 25 R	60+60	1495	230/50	275	4	1,5	2	1 1/6	✓	23,9	Forzada Forced	2009	Automático Automatic	Digital	R-452

VITRINAS PASTELERÍA PASTRY DISPLAY CASES

SERIE MAGNUS SERIES

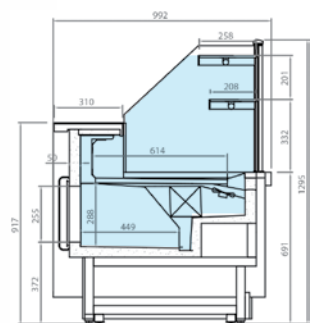

VMG 12 R

VMG 9 R

3.868 €

938x990x1300 mm

C. Clima. 3 [+25°C 60%HR]
Temp. +4°C/+8°C



VMG 12 R

4.351 €

1250x990x1345 mm

C. Clima. 3 [+25°C 60%HR]
Temp. +4°C/+8°C



VMG 12 B

4.670 €

1250x990x1300 mm

C. Clima. 3 [+25°C 60%HR]
Temp. +7°C/+12°C



VMG 15 R

5.142 €

1562x990x1345 mm

C. Clima. 3 [+25°C 60%HR]
Temp. +4°C/+8°C



VMG 18 R

5.616 €

1875x990x1345 mm

C. Clima. 3 [+25°C 60%HR]
Temp. +4°C/+8°C

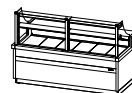

VMG 25 R

6.329 €

2500x990x1345 mm

C. Clima. 3 [+25°C 60%HR]
Temp. +4°C/+8°C

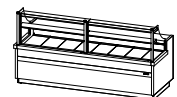





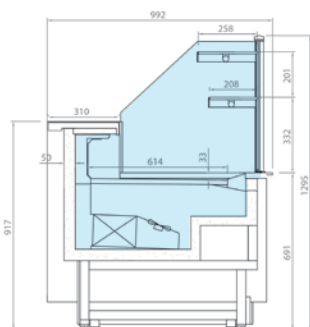







VITRINA EXPOSITORA FRIO VENTILADO MODULAR PARA PASTELERÍA CON RESERVA

REFRIGERATED MODULAR PASTRY DISPLAY CASE WITH STORAGE



VMG 90 A RR

MOD.

	 Costados Sides (mm)	 Potencia Power (W)	 Tensión Frecuencia Electrical [V/Hz]	 Capacidad Capacity (L)	 N° puertas Doors	 Superficie exposición (m ²)	 Estantes Shelving	 Compresor Compressor (HP)	 LED	 Consumo Consumption (kWh/24h)	 Evaporación Evaporation	 Potencia frigorífica Cooling capacity (W a -10°C)	 Desescarche Defrost	 Control	 Refrigerante Coolant
--	---	--	--	--	--	---	---	---	---	---	---	---	---	---	--

VMG 90 AA R	60+60	988	230/50	-	-	0,9	2	5/8	✓	15,8	Forzada Forced	1096	Automático Automatic	Digital	R-452
VMG 90 AC R	60+60	1060	230/50	-	-	1,2	2	3/4	✓	17,0	Forzada Forced	1315	Automático Automatic	Digital	R-452
VMG 90 A R	60+60	1060	230/50	-	-	1,1	2	3/4	✓	17,0	Forzada Forced	1315	Automático Automatic	Digital	R-452
VMG 45 AA R	60+60	662	230/50	-	-	0,8	2	3/8	✓	10,6	Forzada Forced	676	Automático Automatic	Digital	R-452
VMG 45 AC R	60+60	738	230/50	-	-	0,9	2	1/2	✓	11,8	Forzada Forced	817	Automático Automatic	Digital	R-452

SERIE MAGNUS SERIES

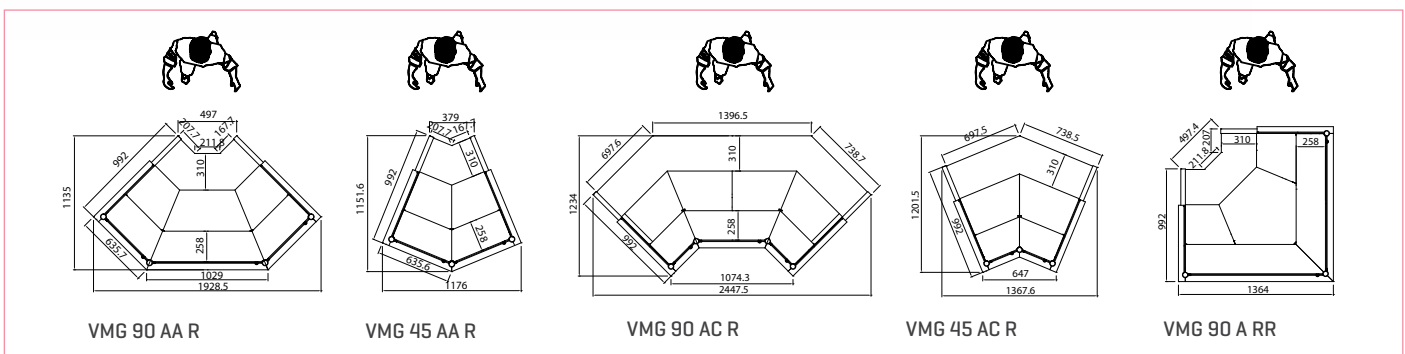

VMG 90 AA R

6.312 €

1365x990x1345 mm

C. Clima. 3 [+25°C 60%HR]
Temp. +4°C/+8°C



VMG 90 AC R

6.820 €

1750x990x1345 mm

C. Clima. 3 [+25°C 60%HR]
Temp. +4°C/+8°C



VMG 90 A RR

5.827 €

1365x990x1345 mm

C. Clima. 3 [+25°C 60%HR]
Temp. +4°C/+8°C



VMG 45 AA R

4.845 €

1180x990x1345 mm

C. Clima. 3 [+25°C 60%HR]
Temp. +4°C/+8°C



VMG 45 AC R

4.891 €

1365x990x1345mm

C. Clima. 3 [+25°C 60%HR]
Temp. +4°C/+8°C



10.

VITRINA EXPOSITORA MODULAR NEUTRA (PANERA)

NEUTRAL MODULAR DISPLAY CASE



VMG 12 P

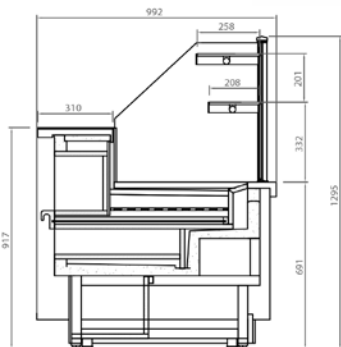

VMG P

VMG 9 P

2.947 €

938x990x1345 mm

VMG 12 P

3.223 €

1250x990x1345 mm

MOD.



Costados
Sides
(mm)



Potencia
Power
(W)



Tensión Frecuencia
Electrical
(V/Hz)



Superficie
exposición
(m²)



Estantes
Shelving



Consumo
Consumption
(kWh/24h)

VMG 9 P

60+60

24

230/50

0,6

2

0,4

VMG 12 P

60+60

30

230/50

0,8

2

0,5



MUEBLE CAJA COUNTER CASE SERIE MAGNUS SERIES

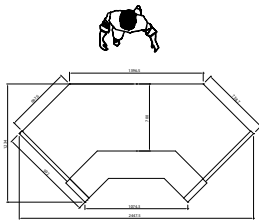

VMG90ACM

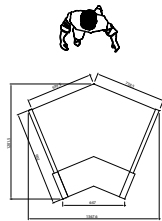

VMG45ACM

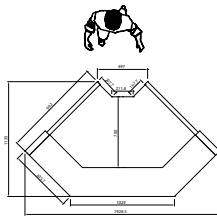

VMG90AAM

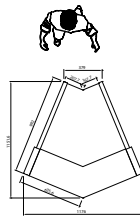

VMG45AAM

VMG 90 AA M

3.000 €

1365x990x1345 mm



VMG 90 AC M

3.635 €

1750x990x1345 mm

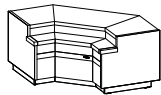

VMG 45 AA M

2.360 €

1180x990x920 mm



VMG 45 AC M

3.164 €

1365x990x920 mm

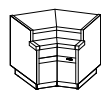

MOD.



Costados
Slides
(mm)



Potencia
Power
(W)



Tensión Frecuencia
Electrical
(V/Hz)



LED



Consumo
Consumption
(kWh/24h)

MOD.	Costados Slides (mm)	Potencia Power (W)	Tensión Frecuencia Electrical (V/Hz)	LED	Consumo Consumption (kWh/24h)
VMG 90 AA M	60+60	7	230/50	✓	0,1
VMG 90 AC M	60+60	10	230/50	✓	0,2
VMG 45 AA M	60+60	5	230/50	✓	0,1
VMG 45 AC M	60+60	7	230/50	✓	0,1

10.

MUEBLE CAJA COUNTER CASE



VMG 12 M
[Nogal]

VMG 9 C

1.685€

938x810x1300 mm

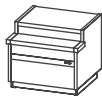

VMG 12 M

2.136€

1250x810x1300 mm

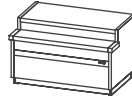

VMG 18 M

2.875€

1875x810x1300 mm



VMG 12MHD

2.450 €

1250x810x1300 mm

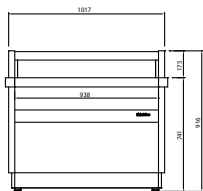

VMG 9C

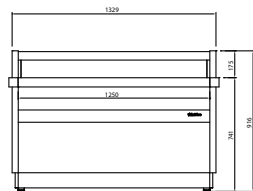

VMG 12M

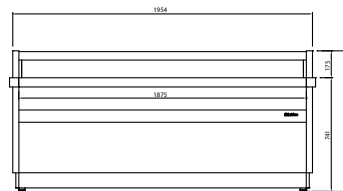

VMG 18M

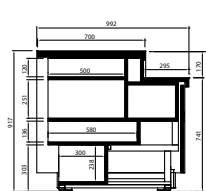

MOD.	Costados Sides (mm)	Potencia Power (W)	Tensión Frecuencia Electrical (V/Hz)	Consumo Consumption (kWh/24h)
VMG 9 C	60+60	5	230/50	0,1
VMG 12 M	60+60	7	230/50	0,1
VMG 18 M	60+60	10	230/50	0,2
VMG 12MHD	60+60	7	230/50	0,1

SERIE MAGNUS SERIES



RAL 4007
Violeta
Violet



RAL 3003
Granate
Maroon



RAL 3020
Rojo
Red



Nogal
Walnut



RAL 2003
Naranja
Orange



RAL 1018
Amarillo
Yellow



RAL 1001
Beige
Beige



Wenge
Wenge



RAL 5015
Azul
Blue



RAL 9016
Blanco
White



RAL 6002
Verde oscuro
Dark green



RAL 9017
Negro
Black



RAL DESIGN
3504035
Rosa
Pink



RAL DESIGN
2108025
Celeste
Sky blue



RAL DESIGN
1107060
Pistacho
Pistachio

ARMARIO EXPOSITOR HELADERÍA

EXHIBING CUPBOARD FOR ICE-CREAM



L03500

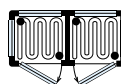

L03700

**MOD.**

	L03500	L03700	L07703
Largo / Wide (mm)	700	700	1320
Fondo/ Depth (mm)	650	650	650
Alto /Height (mm)	1900	1900	1900
Potencia / Power (W)	500	650	1300
Tensión/Frecuencia / Power supply (V/Hz)	220/50	220/50	220/50
Volúmen cámara/ Capacity (L)	420	420	420+420
Nº caras de cristal/ Nº glass sides	1	4	4
Nº de puertas/ Nº doors	1	1	2
Nº de estantes / Nº shelves	5 fijos+1móvil	5 fijos + 1 móvil 5 fixed + 1 mobile	5+5 fijos + 1+1 móvil 5+5 fixed + 1+1 mobile
Compresor / Compressor (HP)	1/2	1/2	1/2 + 1/2
Condensación / Condensation	Ventilada Ventilated	Ventilada Ventilated	Ventilada Ventilated
Evaporación/ Evaporation	Estática Static	Estática Static	Estática Static
Temperatura / Temperature (30°C)	-15°C/ -24°C	-15°C / -24°C	-15°C / -24°C
Desescarche / Defrost	Manual Manual	Manual Manual	Manual Manual
Control	Digital	Digital	Digital
Precio/ Price (€)	2.709	3.563	5.999

- Estructura en aluminio anodizado, con decoración de serie en Plata.
- Exposición de 1 a 4 caras en cristal.
- Organización interior compuesta de 5 parrillas fijas y una móvil por puerta.
- Parrillas interiores de 530x450
- Iluminación interior LED
- Ruedas en todos los modelos.
- Opcional: Terminación en negro
- Opcional: Cerradura

- Anodised aluminium structure with round forms, and with silver series decorations.
- Four face glass exhibition.
- Interior organisation made up of 5 fixed shelved and one that can be moved at the door.
- Interior shelves of
- LED lighting
- Castors in all of the models.
- Optional: Black decoration
- Optional: Locked

ARMARIO EXPOSITOR PASTELERÍA

EXHIBITING CUPBOARD FOR BAKERY



LO3702



LO 7700

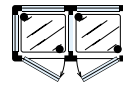

- Estructura en aluminio anodizado con decoración de serie en Plata.
- Exposición de 1 a 4 caras en cristal.
- Organización interior compuesta de 5 estantes en cristal por puerta, regulables en altura, excepto el Modelo LO 3701 con 6 estantes giratorios en cristal.
- Estantes interiores en cristal de 530x450 mm [Mod. LO3505, LO3702, LO7700].
- Estantes giratorios de diámetro 460 mm [Mod. LO3701].
- Iluminación interior. Led
- Ruedas en todos los modelos.
- Humedad Hr. 40% a 60%
- Opcional: Terminación negro
- Opcional: Cerradura
- Opcional: Chocolates. Temp +15°C/+18°C

- Anodised aluminium structure with round forms, and with silver series decorations.
- Four face glass exhibition.
- Interior organisation made up of 5 glass shelves by door, able to regulate in height, except Model LO 3701 with 6 rotating shelves in glass.
- Interior shelves in glass of 530x450 [Mod. LO3505, LO3702, LO7700].
- Rotating shelved with a 460 diameter [Mod. LO3701].
- Interior illumination. Led
- Castors in all of the models.
- Humidity Hr. 40% to 60%
- Optional: Black decoration
- Optional: Lock
- Optional: Chocolate. Temp +15°C/+18°C

MOD	LO3505	LO3702	LO3701	LO7700
Largo / Wide (mm)	700	700	700	1320
Fondo / Depth (mm)	650	650	650	650
Alto /Height (mm)	1900	1900	1900	1900
Potencia / Power (W)	450	550	580	1100
Tensión/Frecuencia / Power supply (V/Hz)	220/50	220/50	220/50	220/50
Volúmen cámara / Capacity (L)	420	420	420	420+420
Nº caras de cristal / Nº glass sides	1	4	4	4
Nº de puertas / Nº doors	1	1	1	2
Nº de estantes / Nº shelves	5	5	6 giratorios	5+5
Compresor / Compressor (HP)	1/4	1/4	1/4	1/4 + 1/4
Condensación / Condensation	Ventilada Ventilated	Ventilada Ventilated	Ventilada Ventilated	Ventilada Ventilated
Evaporación / Evaporation	Estática Static	Estática Static	Estática Static	Estática Static
Temperatura / Temperature (30°C)	+2°C/+10°C	+2°C / +10°C	+2°C / +10°C	+2°C / +10°C
Desescarche / Defrost	Automático Automatic	Automático Automatic	Automático Automatic	Automático Automatic
Control	Digital	Digital	Digital	Digital
Precio / Price (€)	2.475	3.005	3.259	5.322

ARMARIO EXPOSITOR HELADERÍA-PASTELERÍA (NO-FROST) EXHIBITING CUPBOARD FOR ICE-CREAM/BAKERY (NO-FROST)



LO 7703 VNP



LO 3500 VNP

- Este sistema de refrigeración permite la inserción en la misma vitrina, tanto productos de pastelería como de heladería, simplemente regulando la temperatura del termostato.
- Estructura en aluminio anodizado con decoración de serie en Plata.
- Exposición desde 1 hasta 4 caras en cristal.
- Organización interior compuesta de 5 parrillas por puerta, regulables en altura, excepto el Modelo LO 3701VNP con 6 estantes giratorios en cristal.
- Estantes interiores en rejilla cromada de 530x450 mm.
- Estantes giratorios de diámetro 460 mm [Mod. LO3701VNP].
- Iluminación interior LED
- Ruedas en todos los modelos.
- Opcional: Terminación en negro
- Opcional: Cerradura

- This refrigeration system allows insertion in the display of bakery products as well as ice cream, simply regulating the temperature of the thermostat.
- Anodised aluminium structure with rounded forms, and with silver series decoration.
- Exhibit of 1 to 4 glass sides.
- Interior organisation made up of 5 glass shelves by door, able to regulate in height, except Model LO 3701VNP with 6 rotating shelves in glass.
- Interior shelves in chrome grill of 530x450 mm.
- Rotating shelved with a 460 diameter [Mod. LO3701VNP].
- Digital thermostat.
- LED
- Castors in all of the models.
- Optional: Black decoration
- Optional: lock



MOD

	LO3500VNP	LO3700VNP	LO3701VNP	LO7703VNP
Largo / Wide (mm)	700	700	700	1320
Fondo / Depth (mm)	650	650	650	650
Alto /Height (mm)	1900	1900	1900	1900
Potencia / Power (W)	750	900	930	1800
Tensión/Frecuencia / Power supply (V/Hz)	220/50	220/50	220/50	220/50
Volúmen cámara / Capacity (L)	420	420	420	420+420
Nº caras de cristal / Nº glass sides	1	4	4	4
Nº de puertas / Nº doors	1	1	1	2
Nº de estantes / Nº shelves	5	5	6 giratorios	5+5
Compresor / Compressor (HP)	5/8	5/8	5/8	5/8+5/8
Condensación / Condensation	Ventilada Ventilated	Ventilada Ventilated	Ventilada Ventilated	Ventilada Ventilated
Evaporación / Evaporation	Ventilada Ventilated	Ventilada Ventilated	Ventilada Ventilated	Ventilada Ventilated
Temperatura / Temperature (30°C)	+5°C /-20°C	+5°C /-20°C	+5°C /-20°C	+5°C /-20°C
Desescarche / Defrost	Automático Automatic	Automático Automatic	Automático Automatic	Automático Automatic
Control	Digital	Digital	Digital	Digital
Precio / Price (€)	3.387	4.319	4.583	7.410

ARMARIO EXPOSITOR HELADERÍA-PASTELERÍA (NO-FROST) LÍNEA MAXI EXHIBITING CUPBOARD FOR ICE-CREAM/BAKERY [NO-FROST] MAXI LINE



LO 9324 VNP

- Este sistema de refrigeración permite la inserción en la misma vitrina, tanto productos de pastelería como de heladería, simplemente regulando la temperatura del termostato.
- Estructura en aluminio anodizado de formas redondeadas, con decoración de serie en Plata.
- Exposición desde 1 hasta 4 caras en cristal.
- Organización interior compuesta de 5 parrillas por puerta, regulables en altura.
- Estantes interiores en rejilla cromada de 730x450 mm.
- Iluminación interior LED
- Ruedas en todos los modelos.
- Opcional: Terminación en negro
- Opcional: Cerradura

- This refrigeration system allows insertion in the display of bakery products as well as ice cream, simply regulating the temperature of the thermostat.
- Anodized aluminium structure with rounded forms, and with silver series decoration.
- Exhibit of 1 to 4 glass sides.
- Interior organisation made up of 5 glass shelves by door, able to regulate in height.
- Interior shelves in chrome grill of 730x450 mm.
- LED
- Castors in all of the models.
- Optional: Black decoration
- Optional: Lock

LO9311VNP

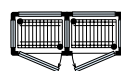

MOD

	LO9311VNP	LO9314VNP	LO9324VNP
Largo / Wide (mm)	900	900	1720
Fondo / Depth (mm)	650	650	650
Alto / Height (mm)	1900	1900	1900
Potencia / Power (W)	900	1200	2400
Tensión/Frecuencia / Power supply (V/Hz)	220/50	220/50	220/50
Volúmen cámara / Capacity (L)	600	600	600+600
Nº caras de cristal / Nº glass sides	1	4	4
Nº de puertas / Nº doors	1	1	2
Nº de estantes / Nº shelves	5	5	5+5
Compresor / Compressor (HP)	1	1	1+1
Condensación / Condensation	Ventilada Ventilated	Ventilada Ventilated	Ventilada Ventilated
Evaporación / Evaporation	Ventilada Ventilated	Ventilada Ventilated	Ventilada Ventilated
Temperatura / Temperature (30 C)	+5°C / -20°C	+5°C / -20°C	+5°C / -20°C
Desescarche / Defrost	Automático Automatic	Automático Automatic	Automático Automatic
Control	Digital	Digital	Digital
Precio / Price (€)	4.247	5.429	9.411

ARMARIOS EXPOSITORES EXHIBING CUPBOARD



Standard
[Silver quartz]



Termostato
SOFT TOUCH



Terminación
WHITE PEARL
[Opcional Optional]



Terminación
BLACK OPAL
[Opcional Optional]

- Gama de armarios expositores en cuatro caras de cristal, disponible en tres versiones: Heladería, Pastelería y No-Frost [Heladería-Pastelería]
- Fabricado en triple cristal sin perfilaría de aluminio, cristal exterior e interior bajo emisivo.
- Terminación estándar SILVER QUARTZ, bajo pedido en BLACK OPAL y WHITE PEARL.
- Disponible en dos longitudes 650mm y 850mm, así como en dos alturas 1500mm [S] y 1900mm [L].
- Iluminación con doble tira de LED con luz continua, mejora la visibilidad del producto expuesto.
- Sistema NO-FOG antiempañamiento en la puerta, exclusivo de la gama de Heladería y No-Frost, nos permite mejorar la visibilidad del producto expuesto en los casos que exista apertura frecuente de la puerta.
- Nuevo termostato SOFT TOUCH con pantalla gráfica de 2.8" y teclado táctil interactivo. Nos permite la visualización y monitorización de múltiples funciones como gráficos de temperatura, lista de alarmas HACCP así como regulación.
- Modularidad, existe la posibilidad de canalizar diferentes modelos independientemente de su altura y medida.
- Estructura con ruedas.

Opcional:

- Modelos con 1,2,3 caras de cristal.
- Barra iluminación LED adicional
- Voltaje y frecuencia [220V/60Hz o 115V/60Hz]
- Módulo para canalizar

- Range of display cabinets on four sides of glass, available in three versions: Ice cream, Pastry and No Frost [Ice-cream-Pastry]
- Made of triple glass without aluminum profiles, exterior glass and low emissive interior.
- Standard termination SILVER QUARTZ, on request in BLACK OPAL and WHITE PEARL
- Available in two lengths 650mm and 850mm, as in heights 1500mm [S] and 1900mm [L].
- Double LED strip lighting with continuous light, improves the visibility of the exposed product.
- NO-FOG anti-glare system on the door, exclusive of the Ice Cream and No-Frost range, no seek to improve the visibility of the product exposed in cases that extend the frequent opening of the door.
- New SOFT TOUCH thermostat with 2.8" graphic display and interactive touchpad Allows the visualization and monitoring of multiple functions such as temperature charts, HACCP alarms as well as regulation.
- Modularity, there is the possibility of channelling different models regardless of height and measurement.
- Structure with wheels.

Opcional:

- Models 1,2,3 faces of glass.
- Additional LED strip
- Power supply [220V/60Hz or 115V/60Hz]
- Modular model

M. HOSTELERÍA HORECA EQUIPMENT

SERIE VITRA HELADERIA SERIE



L08114L
(850mm longitud, altura 1900mm)



L06114S
(650mm longitud, altura 1500mm)

- Línea de vitrinas con refrigeración estática, con régimen de temperatura para Heladería [-15°C a -24°C].
- Estantes no regulables en altura, con 4 niveles en el modelo [S] y 5 niveles en el modelo [L]
- Disponible en 4 caras de cristal con terminación de serie en SILVER QUARTZ.

- Line of showcases with static cooling, with temperature regime for ice cream shop [-15°C to -24°C].
- Shelves not adjustable in height, with 4 levels in the model [S] and 5 levels in the model [L]
- Available in 4 sides of glass with standard decoration in SILVER QUARTZ.



MOD	L06114S	L06114L	L08114S	L08114L
Largo / Wide (mm)	650	650	850	850
Fondo / Depth (mm)	650	650	650	650
Alto / Height (mm)	1500	1900	1500	1900
Potencia / Power (W)	600	900	850	900
Tensión/Frecuencia / Power supply (V/Hz)	220/50	220/50	220/50	220/50
Capacidad útil (L)	300	450	450	600
Nº de estantes / Nº shelves	4 fijos	5 fijos	4 fijos	5 fijos
Condensación / Condensation	Ventilada	Ventilada	Ventilada	Ventilada
Evaporación / Evaporation	Estática	Estática	Estática	Estática
Temperatura / Temperature (32°C)	-15°C a -24°C	-15°C a -24°C	-15°C a -24°C	-15°C a -24°C
Control	Digital (soft-touch)	Digital (soft-touch)	Digital (soft-touch)	Digital (soft-touch)
Desescarche / Defrost	Manual	Manual	Manual	Manual
Precio / Price (€)	4.656	5.142	5.869	6.539

ARMARIOS EXPOSITORES

EXHIBITING CUPBOARD



L06214L

[650mm longitud, altura 1900mm]

- Línea de vitrinas con refrigeración estática, con régimen de temperatura para Pastelería [+2°C a +10°C].
- Estantes de cristal regulables en altura de medida 510x450mm modelos de longitud 650mm y de medida 710x450mm modelos de longitud 850mm, 3 niveles en el modelo [S] y 5 niveles en el modelo [L]. Modelo L06215S con 4 estantes de cristal giratorios y Modelo L06215L con 6 estantes de cristal giratorios, diámetro del estante 460mm.
- Disponible en 4 caras de cristal con terminación de serie en SILVER QUARTZ.



L06215S

[650mm longitud, altura 1500mm]

- Line of showcases with static cooling, with temperature range for Pastry [+ 2 °C to + 10 °C].
- Glass shelves adjustable in height of measurement 510x450mm models of length 650mm and of measurement 710x450mm models of length 850mm, 3 levels in model [S] and 5 levels in model [L]. Model L06215S with 4 rotating glass shelves and Model L06215L with 6 rotating glass shelves, shelf diameter 460mm.
- Available in 4 sides of glass with standard decoration in SILVER QUARTZ.



MOD	L06214S	L06214L	L06215S	L06215L	L08214S	L08214L
Largo / Wide (mm)	650	650	650	650	850	850
Fondo / Depth (mm)	650	650	650	650	650	650
Alto /Height (mm)	1500	1900	1500	1900	1500	1900
Potencia / Power (W)	500	550	530	580	600	650
Tensión/Frecuencia / Power supply (V/Hz)	220/50	220/50	220/50	220/50	220/50	220/50
Capacidad / útil (L)	300	450	300	450	450	600
Nº de estantes / Nº shelves	3	5	4 giratorios	6 giratorios	3	5
Condensación / Condensation	Ventilada	Ventilada	Ventilada	Ventilada	Ventilada	Ventilada
Evaporación / Evaporation	Estática	Estática	Estática	Estática	Estática	Estática
Temperatura / Temperature (30°C)	+2°C a +10°C	+2°C a +10°C	+2°C a +10°C	+2°C a +10°C	+2°C a +10°C	+2°C a +10°C
Desescarche / Defrost	Automático	Automático	Automático	Automático	Automático	Automático
Precio / Price (€)	4.220	4.695	4.578	5.131	5.086	5.645

SERIE VITRA HELADERÍA / PASTELERÍA NO-FROST SERIE



L08314L

[850mm longitud, altura 1900mm]

- Línea de vitrinas con refrigeración ventilada, con régimen de temperatura para Pastelería o Heladería [+5°C a -20°C].
- Estantes de cristal regulables en altura de medida 510x450mm modelos de longitud 650mm y de medida 710x450mm modelos de longitud 850mm, 3 niveles en el modelo [S] y 5 niveles en el modelo [L]. Modelo L06315S con 4 estantes de cristal giratorios y Modelo L06315L con 6 estantes de cristal giratorios, diámetro del estante 460mm.
- Disponible en 4 caras de cristal con terminación de serie en SILVER QUARTZ.



L06314L

[650mm longitud, altura 1900mm]

- Line of showcases with ventilated cooling, with temperature range for Pastry or Ice cream [+ 5°C to -20°C].
- Glass shelves adjustable in height of measurement 510x450mm models of length 650mm and of measurement 710x450mm models of length 850mm, 3 levels in model [S] and 5 levels in model [L]. Model L06315S with 4 rotating glass shelves and Model L06315L with 6 rotating glass shelves, shelf diameter 4.
- Available in 4 sides of glass with standard decoration in SILVER QUARTZ.



MOD	L06314S	L06314L	L06315S	L06315L	L08314S	L08314L
Largo / Wide (mm)	650	650	650	650	850	850
Fondo / Depth (mm)	650	650	650	650	650	650
Alto / Height (mm)	1500	1900	1500	1900	1500	1900
Potencia / Power (W)	850	900	880	930	1150	1200
Tensión/Frecuencia / Power supply (V/Hz)	220/50	220/50	220/50	220/50	220/50	220/50
Capacidad útil (L)	300	450	300	450	450	600
Nº de estantes / Nº shelves	3	5	4 giratorios	6 giratorios	3	5
Condensación / Condensation	Ventilada	Ventilada	Ventilada	Ventilada	Ventilada	Ventilada
Evaporación / Evaporation	Ventilada	Ventilada	Ventilada	Ventilada	Ventilada	Ventilada
Temperatura / Temperature (30°C)	+5°C a -20°C	+5°C a -20°C	+5°C a -20°C	+5°C a -20°C	+5°C a -20°C	+5°C a -20°C
Desescarche / Defrost	Automático	Automático	Automático	Automático	Automático	Automático
Precio / Price (€)	5.668	6.282	6.036	6.707	6.987	7.747

VITRINA VERTICAL 4 CARAS DE CRISTAL – PV 400 / 800 LITROS



PV 400 TNV-PG



PV 400 TBV-PQ

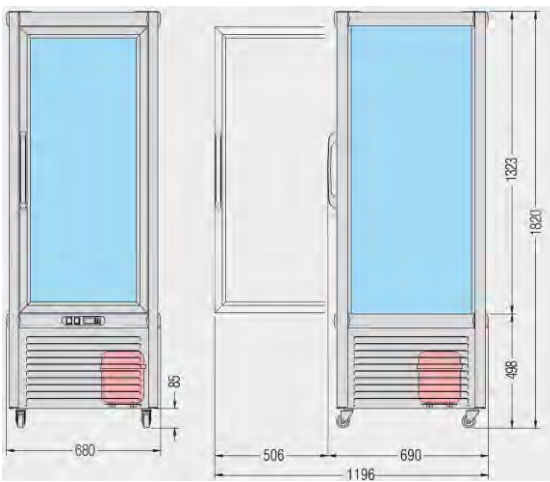

TNV PF-PG-PQ
TBV PF-PG

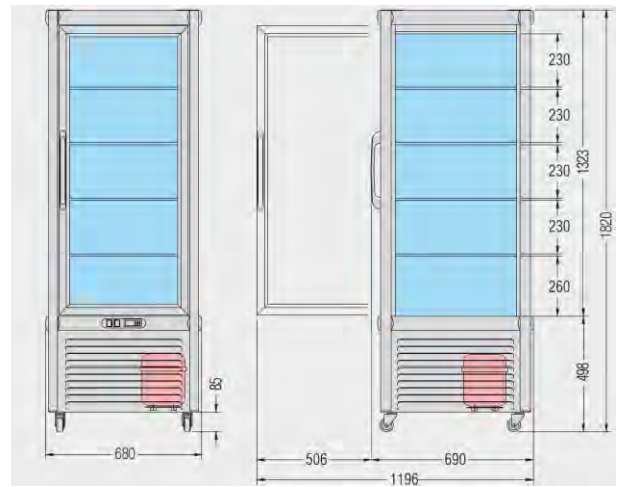

TBS-PF

MODELO	TEMPERATURA TRABAJO °C	EVAPORADOR	ESTANTES Nº / MEDIDA / TIPO	DIMENSIÓN EXTERIOR largo x ancho x alto	CAPACIDAD LITROS	POTENCIA FRIGORÍFICA W	DESCONGELACIÓN	PESO NETO KG
PV 400 TNV-PF	+4 / +10	VENTILADO	5 / 435 x 505 / REJILLA INOX	680 x 690 x 1820	400	580	AUT. CON PAUSA TERMOESTÁTICA	160
PV 400 TNV-PG	+4 / +10	VENTILADO	5 / 465 Ø / CRISTAL GIRATORIO			590	AUT. CON PAUSA TERMOESTÁTICA	168
PV 400 TNV-PQ	+4 / +10	VENTILADO	5 / 430 x 500 / CRISTAL FIJO			600	AUT. CON PAUSA TERMOESTÁTICA	170
PV 400 TBS-PF	-5 / -17	ESTÁTICO CON REJILLAS FIJAS	3 / 460 x 503 / REJILLA 2 / 435 x 505 / REJILLA			600	MANUAL	178
PV 400 TBV-PF	-10 / -17	VENTILADO	5 / 435 X 505 / REJILLA INOX			620	AUT. CON GAS CALIENTE	180
PV 400 TBV-PG	-10 / -17	VENTILADO	5 / 465 Ø / CRISTAL GIRATORIO			620	AUT. CON GAS CALIENTE	180

* TNV: TEMPERATURA POSITIVA ESTÁTICA

* TBV: TEMPERATURA NEGATIVA VENTILADA

* TBS: TEMPERATURA NEGATIVA ESTÁTICA

* PF: ESTANTE DE REJILLAS

* PG: ESTANTE DE CRISTAL GIRATORIO

* PQ: ESTANTE DE CRISTAL FIJO



PV 800 TNV PQ

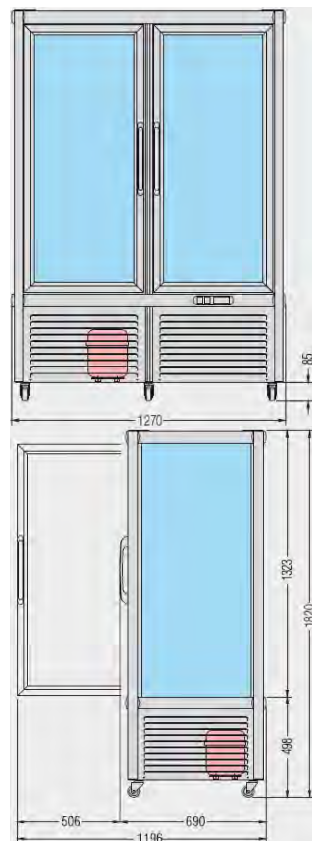

MODELO	TEMPERATURA TRABAJO °C	EVAPORADOR	ESTANTES POR PUERTA N° / MEDIDA / TIPO	DIMENSIÓN EXTERIOR largo x ancho x alto	CAPACIDAD LITROS	POTENCIA FRIGORÍFICA W	DESCONGELACIÓN	PESO NETO KG
PV 800 TNV-PG PF	+4 / +10	VENTILADO	5 / 465 Ø / CRISTAL GIRATORIO	1270 x 690 x 1820	800	850	AUT. CON PAUSA TERMOESTÁTICA	260
			5 / 435 x 505 / REJILLA INOX					
PV 800 TNV-PG PQ	+4 / +10	VENTILADO	5 / 465 Ø / CRISTAL GIRATORIO	1270 x 690 x 1820	800	850	AUT. CON PAUSA TERMOESTÁTICA	265
			5 / 430 x 500 / CRISTAL FIJO					
PV 800 TNV-PF AMBOS	+4 / +10	VENTILADO	10 / 435 x 505 / REJILLA INOX	1270 x 690 x 1820	800	850	AUT. CON PAUSA TERMOESTÁTICA	250
PV 800 TNV-PQ AMBOS	+4 / +10	VENTILADO	10 / 430 x 500 / CRISTAL FIJO	1270 x 690 x 1820	800	850	AUT. CON PAUSA TERMOESTÁTICA	265
PV 800 TNV-PF	+4 / +10	VENTILADO	5 / 435 x 505 / REJILLA INOX	1270 x 690 x 1820	800	1180	AUT. CON PAUSA TERMOESTÁTICA	290
TBS-PF	-5 / -17	ESTÁTICO	3 / 460 x 503 / REJILLA FIJA 2 / 435 x 505 / REJILLA INOX				MANUAL	
PV 800 TNV-PQ	+4 / +10	VENTILADO	5 / 430 x 500 / CRISTAL FIJO	1270 x 690 x 1820	800	1170	AUT. CON PAUSA TERMOESTÁTICA	295
TBS-PQ	-5 / -17	ESTÁTICO	5 / 430 x 500 / CRISTAL FIJO				MANUAL	
PV 800 TBS-PF AMBOS	-5 / -17	ESTÁTICO	6 / 460 x 503 / REJILLA FIJA 4 / 435 x 505 / REJILLA INOX	1270 x 690 x 1820	800	940	MANUAL	280

CARACTERÍSTICAS:

- CONTROL DIGITAL
- LUZ MEDIANTE NEÓN
- GAS REFRIGERANTE: R404A
- VOLTAJE 220 - 240 V / 1 / 50 HZ

OPCIONES:

- KIT RUEDAS PIVOTANTES
- CIERRE CON LLAVE
- LUZ MEDIANTE LED

Vitrina fría sobre mostrador

Vitrina frigorífica sobre mostrador. Laterales de vidrio y puertas traseras deslizantes. Desescarche automático. Sin CFC.

- Bastidor de ABS
- Frontal de vidrio curvado
- Iluminación por LED
- 2 estanterías ajustables



R
600a

POLAR
REFRIGERATION

Código	Descripción	Precio excl. IVA
1 CC611	Negra. 100Ltr.	669,00€
2 CC666	Blanca. 100Ltr.	669,00€

Características
220-240V. 160W. Rango de temperatura: 2°C a 12°C. Temp. ambiente máx: 32°C.
Refrigerante R600a. Tamaño (mm): 675(Al) x 682(An) x 450(P). Peso 39,1kg.

Vitrinas refrigeradas pasteleras

Vitrina refrigerada para una atractiva presentación de pasteles, tartas o postres. Desescarche automático. Ventilación forzada para un mejor mantenimiento de temperatura. Puertas traseras deslizantes para facilitar el acceso al interior. Vidrios calefactables para minimizar la condensación. Estantes ajustables.



- Acabado acero inoxidable
- Ventilación forzada
- Vidrio de triple capa
- Desescarche automático
- Rodillos para desplazamiento
- Vidrios calefactables

R
290

POLAR
REFRIGERATION

Código	Descripción	Precio excl. IVA
3 GG216	900(An)mm/ 300Ltr.	2899,00€
4 GG217	1200(An)mm/ 400Ltr.	3399,00€
GG218	1500(An)mm/ 500Ltr.	3999,00€

Características
GG216 230V. 50/60Hz. Capacidad: 300Ltr. Rango temperatura +2°C a +8°C.
Refrigerante: R290. Medidas (mm): 1200(AL)x 900(An)x 715(F). Peso 230kg.
GG217 230V. 50/60Hz. Capacidad: 400Ltr. Rango temperatura +2°C a +8°C.
Refrigerante: R290. Medidas (mm): 1200(AL)x 1200(An)x 715(F). Peso 286kg.
GG218 230V. 50/60Hz. Capacidad: 500Ltr. Rango temperatura +2°C a +8°C.
Refrigerante: R290. Medidas (mm): 1200(AL)x 1500(An)x 715(F). Peso 323kg.

REFRIGERACIÓN Y CONGELACIÓN / VITRINAS REFRIGERADAS

Vitrinas refrigeradas

Vitrina expositora de cuatro caras de vidrio con frontal curvado y control de temperatura digital. Mantenga frías bebidas, postres y lácteos. Puertas traseras correderas para un acceso fácil y cómodo.



- Luz LED interior
- 2 estanterías de cromo ajustables
- Puertas correderas traseras

Características
 CD229 230V. 160W. 1,3A. Rango de temperatura: +2°C a +12°C. Temp. ambiente máx.: 32°C. Refrigerante R600A. Capacidad: 120Ltr. Tamaño (mm): 686(Al) x 707(An) x 568(P). Peso: 64kg.

Código	Descripción	Precio excl. IVA
CD229	120Ltr	865,00€

R
600a



Frigorífico bajo mostrador

Frigorífico bajo mostrador con termostato variable, robusta construcción y pies de altura regulable para una instalación más cómoda.



- Puerta reversible de vidrio doble
- Termostato variable
- Estantes y pies ajustables

Características
 CF750 230V. 85W. 0,55A. Capacidad 88Ltr. Rango temperatura 1°C a 12°C. Máxima temperatura ambiente 32°C. Refrigerante R600a. 6 estantes. Medidas (mm): 825(Al) x 430(An) x 480(F). Peso 26kg.

Código	Descripción	Precio excl. IVA
CF750	88Ltr	295,80€

R
600a



Vitrina expositora Deli frontal vidrio curvado

Atractiva vitrina con el frontal de vidrio curvado, perfecta para mostrar repostería, pastelería, sandwiches y otros productos frescos. Puertas deslizantes en la parte trasera para facilitar el acceso, el servicio y la reposición. Ventilación forzada y desescarche automático.



- Capacidad 270 litros
- Controlador digital
- 2 estantes
- Iluminación LED
- Acero inoxidable
- Ruedas

Características
 CG841 230V. 850W. 3,7A. Rango temperatura 2°C a 12°C. Máxima temperatura ambiente: 32°C. Refrigerante R600a. Capacidad 270Ltr. Medidas (mm): 1275(Al) x 915(An) x 725(F). Peso 188kg.

Código	Descripción	Precio excl. IVA
CG841	915(An)mm	2269,00€

R
600a



Arcón congelador

Arcones congeladores eficientes, fiables y de fácil limpieza, con puertas correderas de vidrio con cerradura. Gran capacidad y de bajo nivel sonoro, perfectos para tiendas



Características
 CM433 230V. 200W. 1,2A. Grosor del aislamiento: 75mm. Rango temperatura -24°C a -18°C. Max Temperatura ambiente 32°C. Refrigerante R600a. Capacidad 200Ltr. Tamaño: 920(Al) x 953(An) x 553(P)mm. Peso: 42kg.
 CM434 230V. 250W. 1,2A. Grosor del aislamiento: 75mm. Rango temperatura -24°C a -18°C. Max Temperatura ambiente 32°C. Refrigerante R600a. Capacidad 270Ltr. Tamaño: 928(Al) x 1195(An) x 654(P)mm. Peso: 60kg.

Código	Descripción	Precio excl. IVA
CM433	200Ltr	599,00€
CM434	270Ltr	799,00€

R
600a



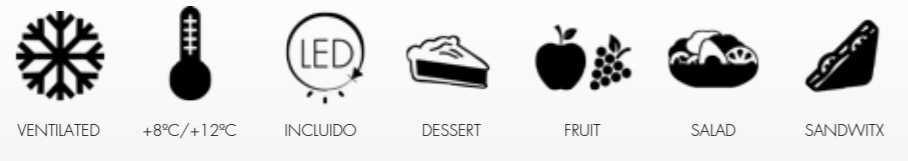

"PARA HACER UNA TARTA DE MANZANA PRIMERO TIENES QUE CREAR UN UNIVERSO"
CARL SAGAN (FÍSICO-ASTRÓNOMO)

DIAMOND LEDS

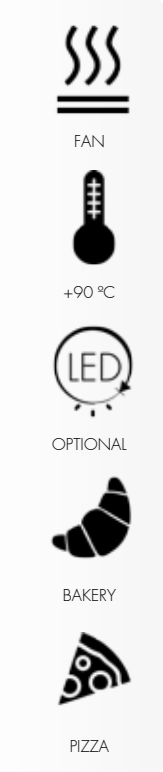
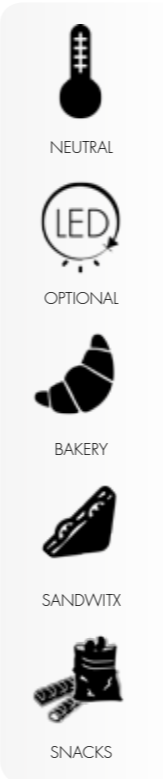

SAYL
DOLCE LINE

DOLCE

	MEDIDAS	ESTANTES (x4)	TEMP.	DIAMONS LED	EUROS
VD	435x435x970	Ø 315	+8/+12°C	SI	1.573 €

EXPOSITOR DOLCE

	MEDIDAS	ESTANTES (x4)	DIAMONS LED	EUROS
EDL	435x435x710	Ø 315	SI	595€
ED	435x435x710	Ø315	NO	450€

CALENTADOR DOLCE

	MEDIDAS	ESTANTES (x4)	DIAMONS LED	EUROS
CEDL	435x435x710	Ø 315	SI	795€
CED	435x435x710	Ø315	NO	685€