



Catálogo de las



# VITRINAS CARNICERAS - CHARCUTERAS

distribuidas en España

# ARMARIOS EXPOSITORES CARNE



**TEKNA**  
glassy line

	Negro Mate
	Aluminio Dorado
	Aluminio Plata
<b>RAL</b>	Posible cualquier otro color. Ver nota adicional en Pg.: 139

Mod. CARNE 1

	Ancho 760mm. Fondo 760 mm. Alto 1.930 mm.
---	---

Mod. CARNE 2

	Ancho 1.500mm. Fondo 760 mm. Alto 1.930 mm.
---	---

Mod. CARNE 3

	Ancho 900mm. Fondo 760 mm. Alto 1.930 mm.
---	---

Mod. CARNE 4

	Ancho 1.780mm. Fondo 760 mm. Alto 1.930 mm.
---	---

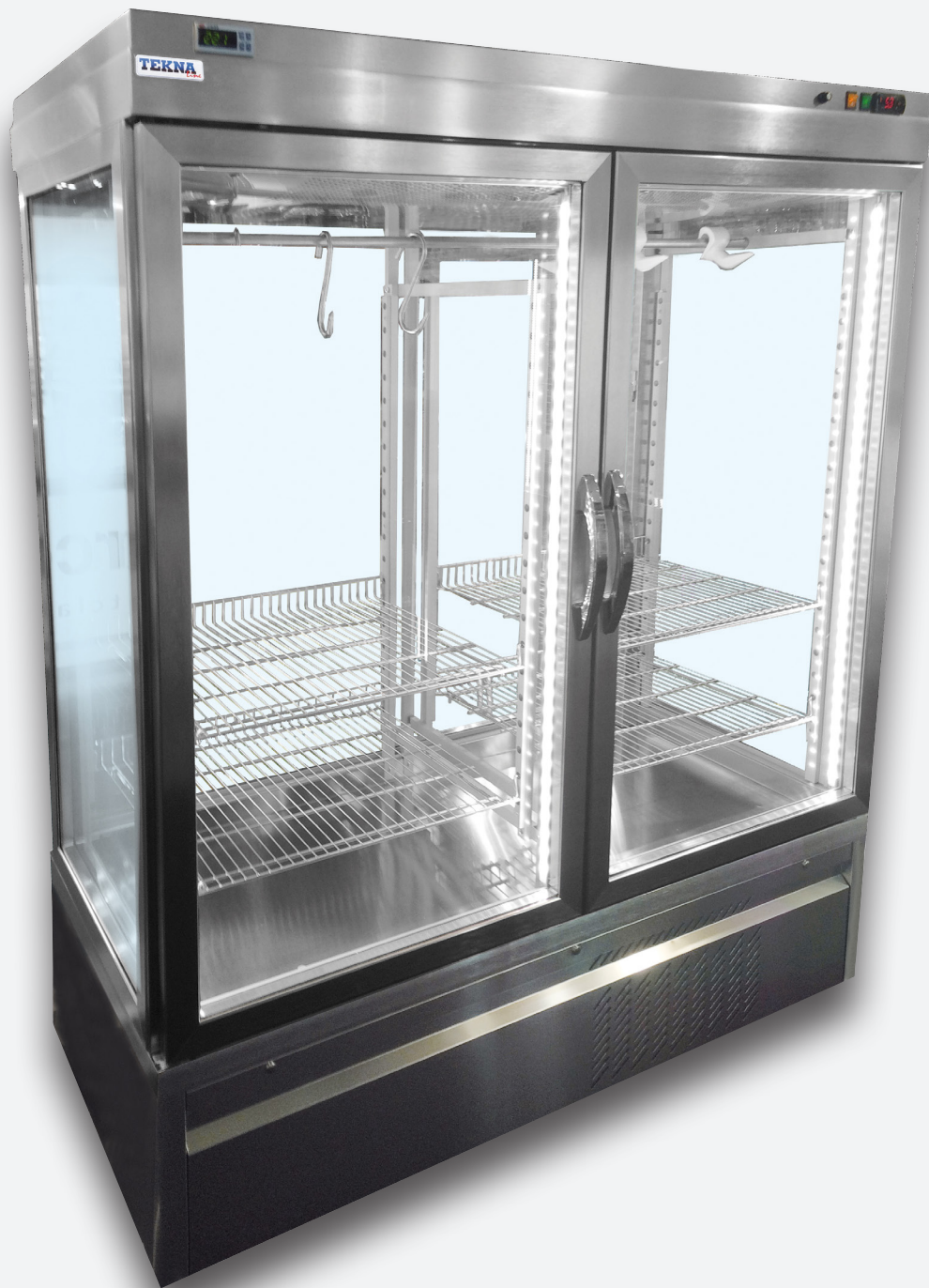

Mod. CARNE 2

Modelos 1 y 3 dotados con 2 estantes y 2 barras.

Modelos 2 y 4 dotados con 4 estantes y 2 barras.









Carne 1 y 2 con estantes de rejilla de 600x550 mm

Carne 3 y 4 con estantes de rejilla de 740x550 mm

Ver accesorios y opciones en pág.: 139.

**NOTA:** Los modelos carne especial para exposición, **bajo pedido para maduración.**

**NOTA:** indicar en el pedido **cristales con válvulas alimétricas** para armarios que deban instalarse a más de 800 m sobre el nivel del mar.

	Modelo	Temp. (°C)	Pot. (W)	ESTÁNDAR P.V.P. €
	 <b>CARNE1 NFP</b>	+10/-5	500	4.414
	 <b>CARNE2 NFP</b>	+10/-5	1.000	6.143
	 <b>CARNE3 NFP</b>	+10/-5	600	5.014
	 <b>CARNE4 NFP</b>	+10/-5	1.200	6.946

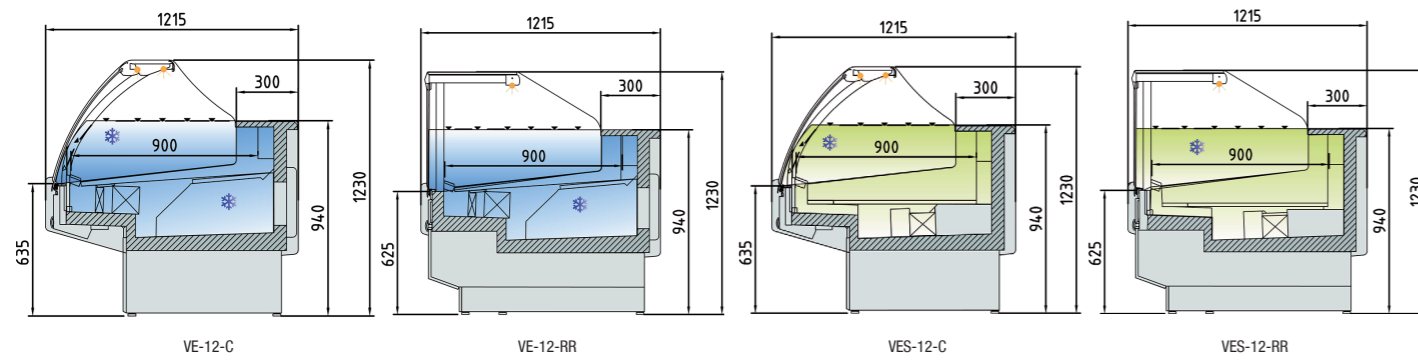

MODELOS CON RESERVA / MODELS WITH RESERVATION / RÉSERVE MODÈLES

MODELOS SIN RESERVA / MODELS WITHOUT RESERVATION / RÉSERVE SANS MODÈLES



VE-12-25-C-TF

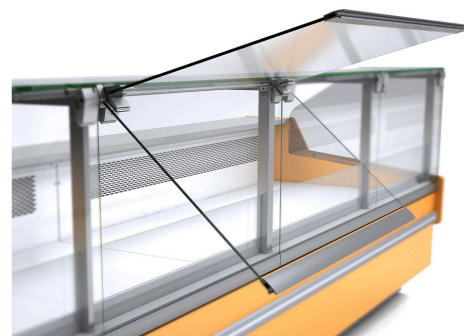

Detalle cristal elevable  
Liftable glass detail  
Detail vitree elevable



Detalle repetidor temperatura  
Display temperature detail  
Detail température repeater



VE-12-25-RR-TF

Ver características técnicas en página 90 / See technical data in page 90 / Voir caractéristiques techniques page 90

Modelo Model Modèle	Largo Length Longueur (mm)	Cámara Storage Stockage (m <sup>3</sup> )	Exposición Display Exposition (m <sup>2</sup> )	Puertas Doors Portes (Uds) (Units)	Potencia frig. Frig. Power Puissance frig. (W)	Consumo Consumption Consommation (W)	Refrigerante Coolant Réfrigérant
VE / VES-12-10-TF	1055	0,4	0,98	1 / 0	635	554	R-452A
VE / VES-12-13-TF	1305	0,52	1,21	2 / 0	817	1105	R-452A
VE / VES-12-15-TF	1525	0,6	1,41	2 / 0	1315	1379	R-452A
VE / VES-12-20-TF	2025	0,81	1,88	3 / 0	1315	1417	R-452A
VE / VES-12-25-TF	2525	1,1	2,34	4 / 0	1497	1689	R-452A
VE / VES-12-30-TF	2995	1,28	2,78	4 / 0	2617	2136	R-452A

230v 60Hz / 115v 60Hz. consultar - consult - consulter

OPCIONES · OPTIONS · OPTIONS

Modelo Model Modèle	1 decoración frontal / front decor / décoration frontal	2 Total decoración / Total decor / décoration total	Cierre Plexi Plexi slide Kit vitrage plexi	Iluminación led extra Extra led lighting Éclairage Led extra	Cierre cortina Night blind Rideau nocturne	Neutra Neutral Neutre	Pre Instalación Remote Unit Groupe à distance
VE / VES-12-10-TF	55 €	270 €	92 €	41 €	82 €	-410 €	-123 €
VE / VES-12-13-TF	60 €	275 €	123 €	53 €	108 €	-461 €	-138 €
VE / VES-12-15-TF	65 €	280 €	138 €	61 €	123 €	-513 €	-148 €
VE / VES-12-20-TF	70 €	285 €	184 €	82 €	164 €	-615 €	-179 €
VE / VES-12-25-TF	75 €	290 €	230 €	102 €	205 €	-872 €	-205 €
VE / VES-12-30-TF	80 €	295 €	277 €	123 €	246 €	-995 €	-256 €

Características técnicas y constructivas sujetas a variación sin previo aviso. / We reserve the right to change specifications without prior notice. / Sujet technique et la conception de modifications sans préavis.

VE-12-10-C-TF <b>3.329 €</b>	VE-12-13-C-TF <b>3.678 €</b>	VE-12-15-C-TF <b>3.955 €</b>	VE-12-20-C-TF <b>4.355 €</b>	VE-12-25-C-TF <b>5.119 €</b>	VE-12-30-C-TF <b>6.002 €</b>
VES-12-10-C-TF <b>3.242 €</b>	VES-12-13-C-TF <b>3.585 €</b>	VES-12-15-C-TF <b>3.862 €</b>	VES-12-20-C-TF <b>4.201 €</b>	VES-12-25-C-TF <b>4.960 €</b>	VES-12-30-C-TF <b>5.837 €</b>
VE-12-10-RR-TF <b>3.329 €</b>	VE-12-13-RR-TF <b>3.678 €</b>	VE-12-15-RR-TF <b>3.955 €</b>	VE-12-20-RR-TF <b>4.355 €</b>	VE-12-25-RR-TF <b>5.119 €</b>	VE-12-30-RR-TF <b>6.002 €</b>
VES-12-10-RR-TF <b>3.242 €</b>	VES-12-13-RR-TF <b>3.585 €</b>	VES-12-15-RR-TF <b>3.862 €</b>	VES-12-20-RR-TF <b>4.201 €</b>	VES-12-25-RR-TF <b>4.960 €</b>	VES-12-30-RR-TF <b>5.837 €</b>

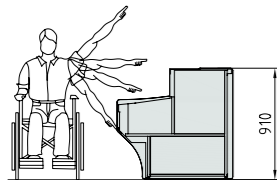
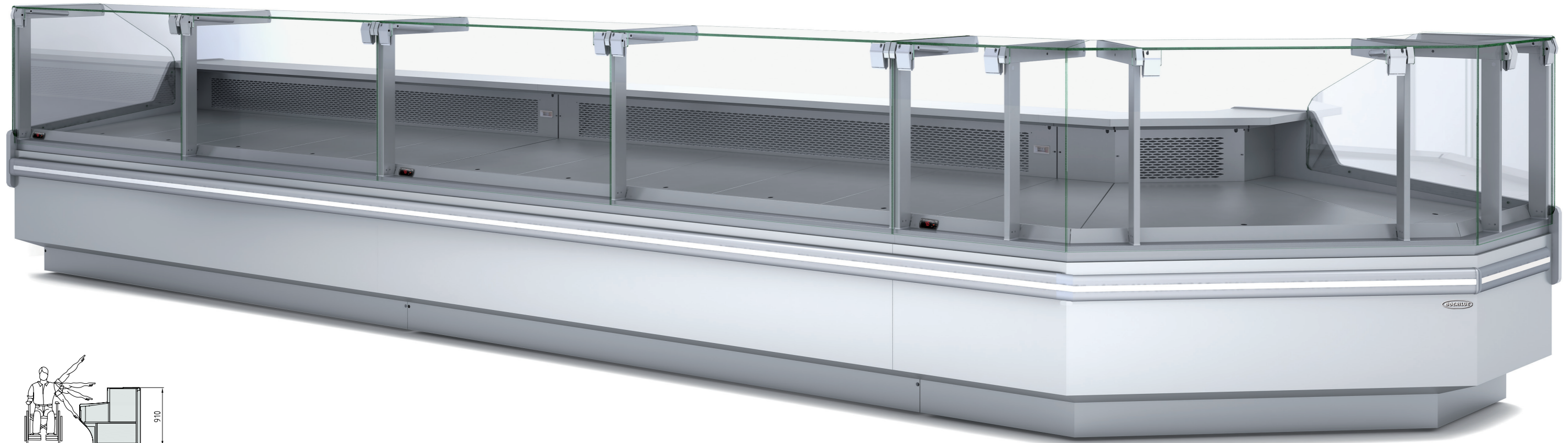

Servicio adaptado  
 Service adapted  
 Service adaptés

Ver características técnicas en página 90 / See technical data in page 90 / Voir caractéristiques techniques page 90

**CARACTERÍSTICAS TÉCNICAS ÁNGULOS REFRIGERADOS**

- Sistema de evaporación ventilado
- VES vitrina sin reserva
- VE vitrina con reserva
- **C:** Cristal curvo
- **RR:** Cristal doble recto
- Todos los modelos sin puerta de reserva

**REFRIGERATED ANGLE TECHNICAL DATA**

- Ventilated evaporation system
- VES without storage
- VE with storage
- **C:** Curved glass
- **RR:** Double flat glass
- All door models without reservation

**CARACTÉRISTIQUES TECHNIQUES DES ANGLES RÉFRIGÉRÉS**

- Système d'évaporation ventilé
- VES sans stockage
- VE stockage
- **C:** Vitre bombée
- **RR:** Vitre double droit
- Tous les modèles sans portes de réserve

**CARACTERÍSTICAS TÉCNICAS MUEBLES CAJAS**

- Todos los modelos con cajón incorporado, estantes y enchufe
- Decoración incluida

**CASH NEUTRAL COUNTER DATA**

- All models include drawer, shelves and plug
- Decoration included

**CARACTÉRISTIQUES TECHNIQUES DES MEUBLE CAISSE**

- Tous les modèles avec tiroir incorporé, étagères et prise électrique
- Décoration inclus

**MUEBLES CAJA NEUTROS**  
**CASH NEUTRAL COUNTER / MEUBLE CAISSE NEUTRE**

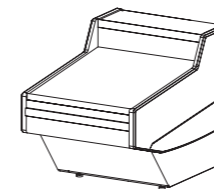

MCVE-12-8 **1.141 €**

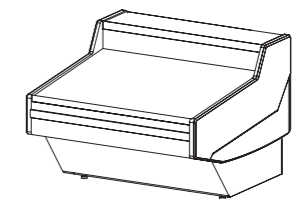

MCVE-12-12 **1.249 €**

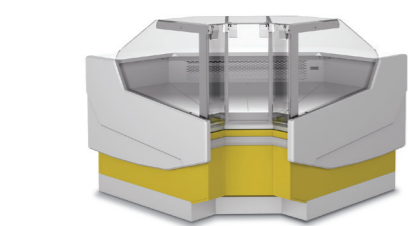

VE-12-AN90-RR **6.550 €** VES-12-AN90-RR **6.720 €**



VE-12-AP90-C **6.315 €** VES-12-AP90-C **6.295 €**  
 VE-12-AP90-RR **6.315 €** VES-12-AP90-RR **6.295 €**

230v 60Hz / 115v 60Hz. consultar - consult - consulter

**OPCIONES · OPTIONS · OPTIONS**

Modelo	1 decoración frontal / front decor / décoration frontal	2 Total decoración / Total decor / décoration total	Neutra	Puertas Cierre Plexi Plexi slide Doors	Cierre cortina	Pre Instalación Remote Unit
Model			Neutral	Kit vitrage arrière coulissant plexi	Rideau nocturne	Groupé à distance
Modèle			Neutre	Kit vitrage arrière coulissant plexi	Rideau nocturne	Groupé à distance
VE/VES-12-AP90	65 €	280 €	-513 €	184 €	164 €	-148 €
VE/VES-12-AN90	65 €	280 €	-513 €	184 €	164 €	-148 €

Características técnicas y constructivas sujetas a variación sin previo aviso / We reserve the right to change specifications without prior notice / Sujet technique et la conception de modifications sans préavis

Modelo Model Modèle	Largo Length Longueur (mm)	Alto Height Hauteur (mm)	Fondo Depth Profondeur (mm)	Cámara Storage Stockage (m³)	Exposición Display Exposition (m²)	Puertas Doors Portes (Uds)	Potencia frig. Frig. Power Puissance frig. (W)	Consumo Consumption Consommation (W)	Refrigerante Coolant Réfrigérant
VE/VES-12-AN90	1562	1230	1562	-	1,3	0	1145	1091	R-452A
VE/VES-12-AP90	1622	1230	1622	-	1,44	0	817	1392	R-452A
MCVE-12-8	800	940	1200	-	0,78	-	-	-	-
MCVE-12-12	1260	940	1200	-	1,22	-	-	-	-

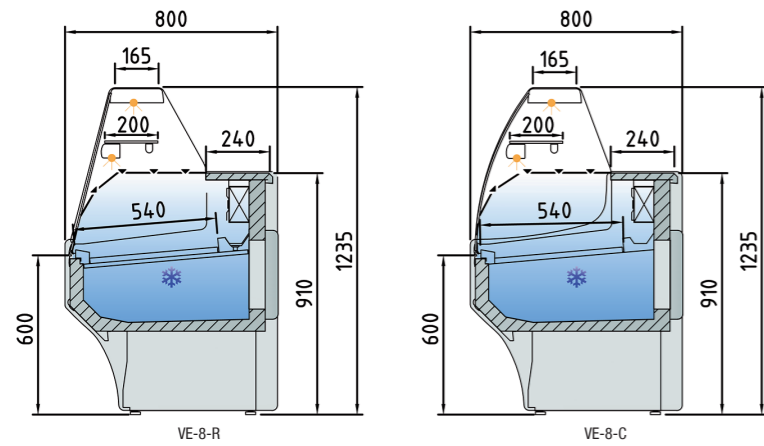

detalle plano de exposición  
display area detail  
Up détail de l'exposition

detalle perfilera anodizada  
anodized profiles detail  
profilis anodisés détail

Estante superior no refrigerado  
Top shelf not refrigerated  
Étagère supérieure non réfrigérée

Ver características técnicas en página 20 / See technical data in page 20 / Voir caractéristiques techniques page 20

Modelo Model Modèle	Largo Length Longueur (mm)	Cámara Storage Stockage (m <sup>3</sup> )	Exposición Display Exposition (m <sup>2</sup> )	Puertas Doors Portes (Uds)	Potencia frig. Frig. Power Puissance frig. (W)	Consumo Consumption Consommation (W)	Refrigerante Coolant Réfrigérant
VE-8-10	1055	0,28	0,54	1	522	397	R-452A
VE-8-13	1305	0,37	0,68	2	522	921	R-452A
VE-8-15	1525	0,43	0,8	2	635	1019	R-452A
VE-8-20	2025	0,57	1,08	3	817	1069	R-452A
VE-8-25	2525	0,72	1,36	4	1096	1364	R-452A
VE-8-30	2995	1,12	1,63	4	1096	1354	R-452A

230v 60Hz / 115v 60Hz. consultar - consult - consulter

Modelo Model Modèle	OPCIONES · OPTIONS · OPTIONS		Cierre Plexi Plexi slide Doors Kit vitrage arrière coulissant plexi	Iluminación led extra Extra led lighting Eclairage led extra	Cierre cortina Night blind Rideau nocturne	Neutra Neutral Neutre	Pre Instalación Remote Unit Groupe à distance
	1 decoración frontal / front decor / décoration frontal	2 Total decoración / Total decor / décoration total					
VE-8-10	55 €	270 €	92 €	41 €	82 €	-410 €	-123 €
VE-8-13	60 €	275 €	123 €	53 €	108 €	-461 €	-138 €
VE-8-15	65 €	280 €	138 €	61 €	123 €	-513 €	-148 €
VE-8-20	70 €	285 €	184 €	82 €	164 €	-615 €	-179 €
VE-8-25	75 €	290 €	230 €	102 €	205 €	-872 €	-205 €
VE-8-30	80 €	295 €	277 €	123 €	246 €	-995 €	-256 €

Características técnicas y constructivas sujetas a variación sin previo aviso. / We reserve the right to change specifications without prior notice. / Sujet technique et la conception de modifications sans préavis.

**VITRINA EXPOSITORA REFRIGERADA VE-8**  
SERVE OVER COUNTER LINE VE-8 · VITRINE SERIE VE-8 GAMME RÉFRIGÉRÉE

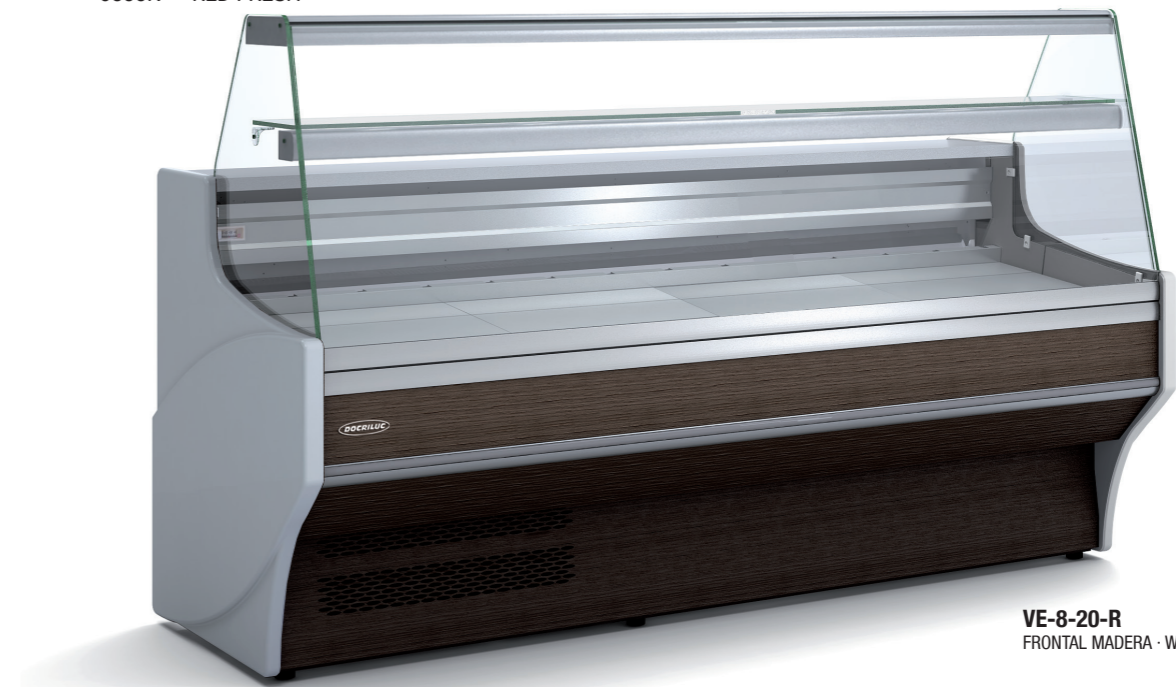

**VE-8-20-R**  
FRONTAL MADERA · WOOD FRONTAL · FRONTALE BOIS



**VE-8-20-C**  
FRONTAL LACADO · LACQUERED FRONTAL · FRONTALE LAQUÉE

VE-8-10-R <b>1.641 €</b>	VE-8-13-R <b>1.816 €</b>	VE-8-15-R <b>1.939 €</b>	VE-8-20-R <b>2.436 €</b>	VE-8-25-R <b>2.785 €</b>	VE-8-30-R <b>3.390 €</b>
VE-8-10-C <b>1.754 €</b>	VE-8-13-C <b>1.944 €</b>	VE-8-15-C <b>2.123 €</b>	VE-8-20-C <b>2.570 €</b>	VE-8-25-C <b>3.006 €</b>	VE-8-30-C <b>3.601 €</b>



**CARACTERÍSTICAS TÉCNICAS**

- Exterior e interior en chapa de acero plastificada
- Plano exposición y encimera en acero inox. AISI-304
- Bandejas plano de exposición lisas, con escalón sobre demanda
- Costados de 40 mm en ABS inyectado
- Perfilera en aluminio anodizado.
- Paragolpes en la parte delantera
- Cristal frontal templado y abatible, cuatro versiones disponibles
- Estante de cristal intermedio, no refrigerado
- Iluminación estándar LED: encimera superior y estante
- Aislamiento de poliuretano inyectado, densidad 40 Kg/m<sup>3</sup>, bajo GWP y cero efecto ODP
- Reserva refrigerada con puertas, hueco 440x270 (excepto modelo neutro y modelo sin reserva)
- Evaporador estático, opcional ventilado
- Condensación ventilada y evaporación automática de serie
- Control electrónico de temperatura con indicador
- Descarcho automático, opcional eléctrico
- Clase climática 4 (30°C 55% Hr) régimen M1 según UNE-EN ISO 23953-2
- Chasis en acero acabado epoxi
- Tensión de trabajo monofásica 220V 50Hz

**TECHNICAL DATA**

- Interior and exterior finish in plastic coated steel
- Display area and counter in stainless steel AISI-304
- Smooth deck for display area, stepped at on demand
- Sides available in ABS injected, 40 mm thickness
- Anodised aluminium profiles
- Front rubber bumper
- Toughened curved glass hinges forward, four versions available
- Glass shelf non refrigerated
- Standard lighting LED: top worktop and shelf
- 40 Kg/m<sup>3</sup> density polyurethane insulation, low GWP and zero ODP effect
- Refrigerated under storage with doors 440x270 free (except neutral model and model without reservation)
- Static evaporator, ventilated as optional
- Ventilated condensation and automatic defrost evaporation as standard
- Electronic temperature control with indicator
- Automatic defrost, electric as optional
- Climatic class 4 (30 ° C 55% Hr) regime M1 according to UNE-EN ISO 23953-2
- Working voltage single phase 220V 50Hz
- Chassis in epoxy finished steel

**CARACTÉRISTIQUES TECHNIQUES**

- Extérieur et intérieur en acier plastifié.
- Surface d'exposition et plan de travail en inox. AISI-304
- Bacs planes à surface d'exposition, possibilité double niveau sur demande
- Côtés en ABS thermoformé, épaisseur 40 mm.
- Profilés en aluminium anodisé
- Pare-chocs en partie frontale
- Vitre droite ou bombée sécurit rabattable
- Étagère en verre non réfrigérée
- Lumière standard en partie haute LED
- Isolation en polyuréthane injecté sans CFC, densité 40Kg/m<sup>3</sup>
- Stockage réfrigéré, espace 440x270 (sauf modèle neutre et le modèle sans réserve)
- Évaporateur statique
- Condensation ventilé, évaporation automatique en standard
- Contrôle électronique de la température avec indicateur
- Dégivrage automatique, électrique en option
- Classe climatique 4 (30 ° C 55% Hr) régime M1 selon UNE-EN ISO 23953-2
- Tension de fonctionnement monophasé 220V 50Hz
- Châssis en acier fini époxy

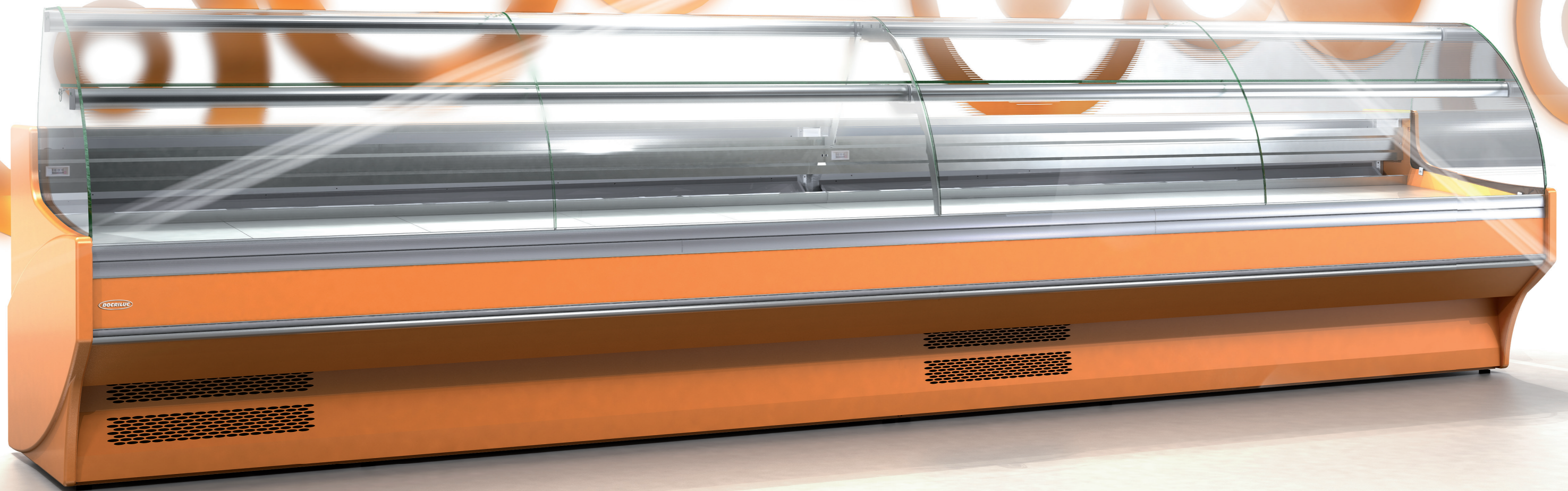

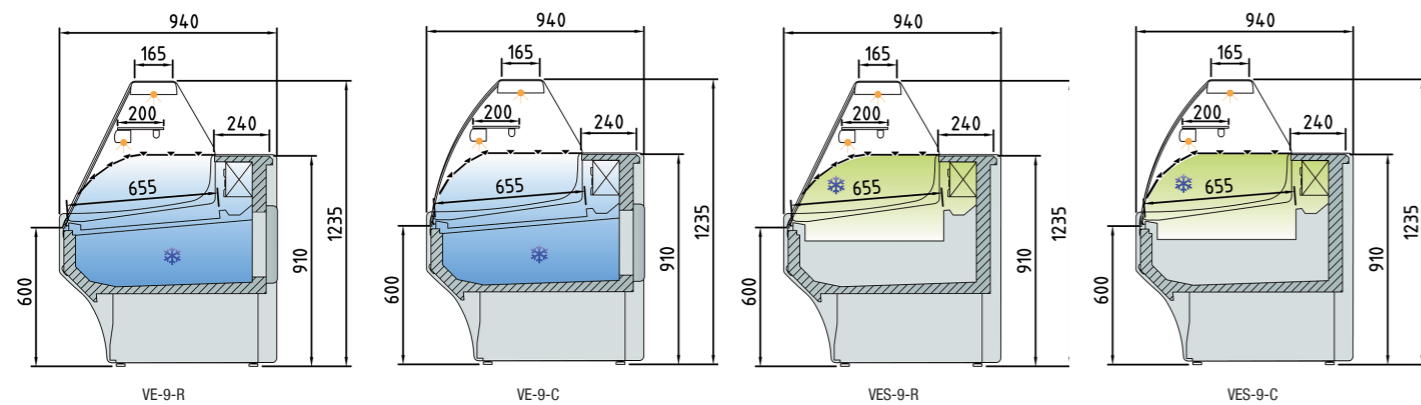

MODELOS CON RESERVA / RESERVE MODELS / RÉSERVE MODÈLES

MODELOS SIN RESERVA / RESERVE WITHOUT MODELS / RÉSERVE SANS MODÈLES

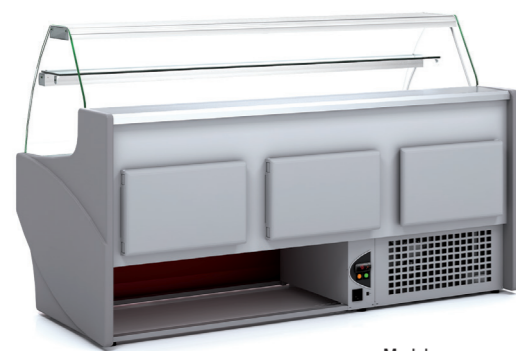

Modelo con reserva VE  
Model with reservation VE  
Modèle avec réserve VE

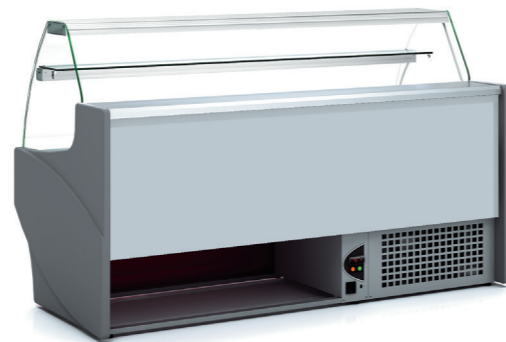

Modelo sin reserva VES  
Model without reservation VES  
Modèle sans réserve VES

Ver características técnicas en página 24 / See technical data in page 24 / Voir caractéristiques techniques page 24

Modelo Modèle	Largo Length Longueur (mm)	Cámara VE Storage VE Stockage VE (m <sup>3</sup> )	Exposición Display Exposition (m <sup>2</sup> )	Puertas VE / VES Doors VE / VES Portes VE / VES (Uds)	Potencia frig. Frig. Power Puissance frig. (W)	Consumo Consumption Consommation (W)	Refrigerante Coolant Réfrigérant
VE / VES-9-10	1055	0,33	0,65	1/0	522	404	R-452A
VE / VES-9-13	1305	0,43	0,82	2/0	635	1009	R-452A
VE / VES-9-15	1525	0,49	0,97	2/0	817	1079	R-452A
VE / VES-9-20	2025	0,67	1,31	3/0	817	1103	R-452A
VE / VES-9-25	2525	0,84	1,65	4/0	1096	1365	R-452A
VE / VES-9-30	2995	1,19	1,96	4/0	1315	1416	R-452A

230v 60Hz / 115v 60Hz. consultar - consult - consulter

**OPCIONES - OPTIONS - OPTIONS**

Modelo Modèle	1 decoración frontal / front decor / décoration frontal	2 Total decoración / Total decor / décoration total	Cierre Plexi Plexi slide Kit vitrage plexi	Cierre cortina Night blind Rideau nocturne	Iluminación led extra Extra led lighting Éclairage Led extra	Neutra Neutral Neutre	Pre Instalación Remote Unit Groupe à distance
VE / VES-9-10	55 €	270 €	92 €	82 €	41 €	-410 €	-123 €
VE / VES-9-13	60 €	275 €	123 €	108 €	53 €	-461 €	-138 €
VE / VES-9-15	65 €	280 €	138 €	123 €	61 €	-513 €	-148 €
VE / VES-9-20	70 €	285 €	184 €	164 €	82 €	-615 €	-179 €
VE / VES-9-25	75 €	290 €	230 €	205 €	102 €	-872 €	-205 €
VE / VES-9-30	80 €	295 €	277 €	246 €	123 €	-995 €	-256 €

Características técnicas y constructivas sujetas a variación sin previo aviso. / We reserve the right to change specifications without prior notice. / Sujet technique et la conception de modifications sans préavis.

**VITRINA EXPOSITORA REFRIGERADA VE-9**  
SERVE OVER COUNTER LINE VE-9 · VITRINE SERIE VE-9 GAMME RÉFRIGÉRÉE



VE-9-20-R

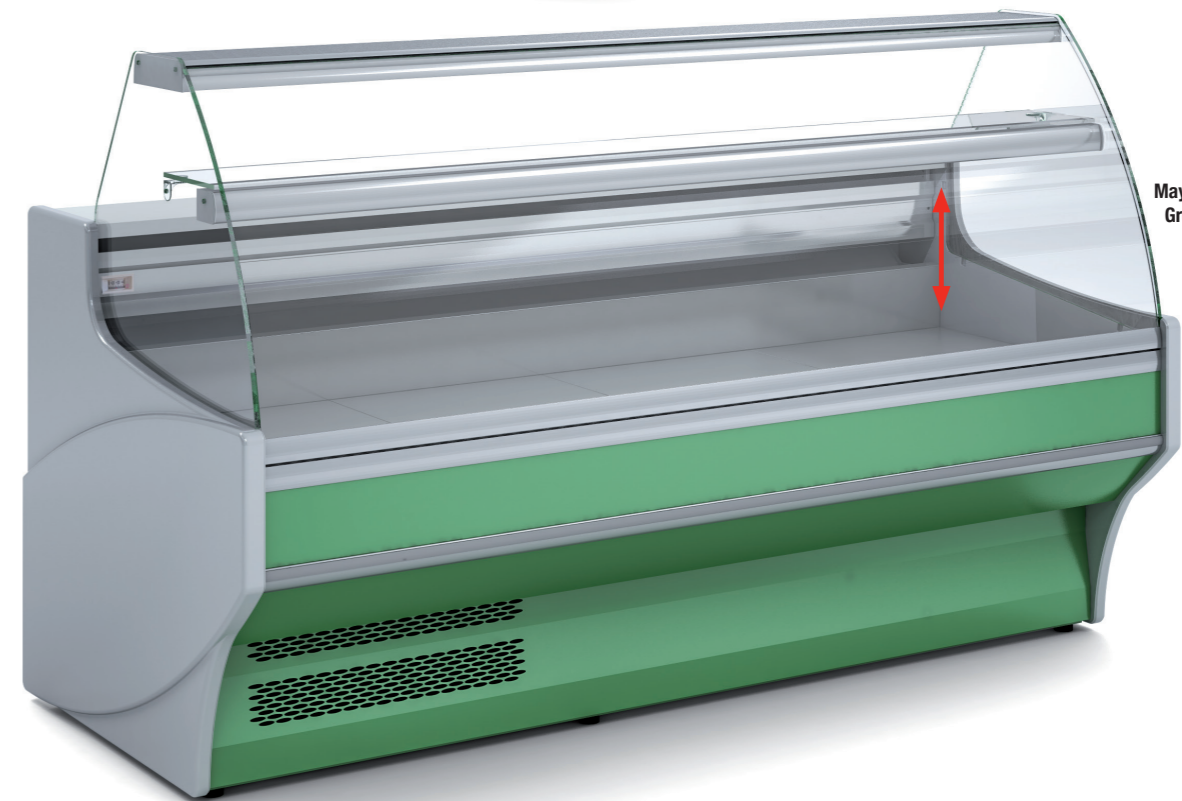

Mayor capacidad modelo VES  
Greater capacity model VES  
Plus capacité modèle VES

VES-9-20-C

VE-9-10-R <b>1.809 €</b>	VE-9-13-R <b>1.987 €</b>	VE-9-15-R <b>2.170 €</b>	VE-9-20-R <b>2.658 €</b>	VE-9-25-R <b>3.108 €</b>	VE-9-30-R <b>3.746 €</b>
VES-9-10-R <b>1.768 €</b>	VES-9-13-R <b>1.904 €</b>	VES-9-15-R <b>2.087 €</b>	VES-9-20-R <b>2.532 €</b>	VES-9-25-R <b>2.941 €</b>	VES-9-30-R <b>3.558 €</b>
VE-9-10-C <b>1.993 €</b>	VE-9-13-C <b>2.197 €</b>	VE-9-15-C <b>2.401 €</b>	VE-9-20-C <b>2.904 €</b>	VE-9-25-C <b>3.390 €</b>	VE-9-30-C <b>4.060 €</b>
VES-9-10-C <b>1.951 €</b>	VES-9-13-C <b>2.113 €</b>	VES-9-15-C <b>2.312 €</b>	VES-9-20-C <b>2.772 €</b>	VES-9-25-C <b>3.217 €</b>	VES-9-30-C <b>3.867 €</b>

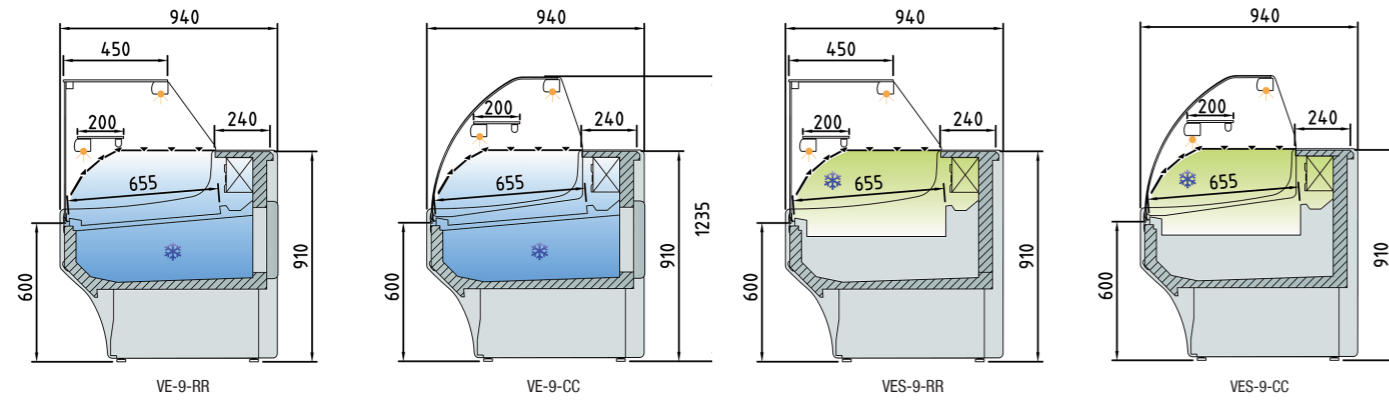

MODELOS CON RESERVA / RESERVE MODELS / RÉSERVE MODÈLES

MODELOS SIN RESERVA / RESERVE WITHOUT MODELS / RÉSERVE SANS MODÈLES



detalle separador de genero  
detail separator genre  
détail séparateur de genre



detalle reserva refrigerada  
Refrigerated reserve detail  
détail du livre réfrigérés

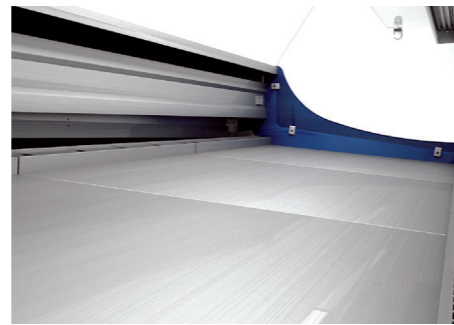

detalle plano de exposición  
display area detail  
Up détail de l'exposition

Ver características técnicas en página 24 / See technical data in page 24 / Voir caractéristiques techniques page 24

Modelo Modél Modèle	Largo Length Longueur (mm)	Cámara VE Storage VE Stockage VE (m <sup>2</sup> )	Exposición Display Exposition (m <sup>2</sup> )	Puertas VE / VES Doors VE / VES Portes VE / VES (Uds)	Potencia frig. Frig. Power Puissance frig. (W)	Consumo Consumption Consommation (W)	Refrigerante Coolant Réfrigérant
VE / VES-9-10	1055	0,33	0,65	1/0	522	404	R-452A
VE / VES-9-13	1305	0,43	0,82	2/0	635	1009	R-452A
VE / VES-9-15	1525	0,49	0,97	2/0	817	1079	R-452A
VE / VES-9-20	2025	0,67	1,31	3/0	817	1103	R-452A
VE / VES-9-25	2525	0,84	1,65	4/0	1096	1365	R-452A
VE / VES-9-30	2995	1,19	1,96	4/0	1315	1416	R-452A

230v 60Hz / 115v 60Hz. consultar - consult - consulter

OPCIONES · OPTIONS · OPTIONS

Modelo Modél Modèle	1 decoración frontal / front decor / décoration frontal	2 Total decoración / Total decor / décoration total	Puertas Cierre Plexi Plexi slide Doors Kit vitrage arrière coulissant plexi	Cierre cortina Night blind Rideau nocturne	Iluminación led blanco White led lighting Éclairage Led blanc	Neutra Neutral Neutre	Pre Instalación Remote Unit Groupe à distance
VE / VES-9-10	55 €	270 €	92 €	82 €	41 €	-410 €	-123 €
VE / VES-9-13	60 €	275 €	123 €	108 €	53 €	-461 €	-138 €
VE / VES-9-15	65 €	280 €	138 €	123 €	61 €	-513 €	-148 €
VE / VES-9-20	70 €	285 €	184 €	164 €	82 €	-615 €	-179 €
VE / VES-9-25	75 €	290 €	230 €	205 €	102 €	-872 €	-205 €
VE / VES-9-30	80 €	295 €	277 €	246 €	123 €	-995 €	-256 €

Características técnicas y constructivas sujetas a variación sin previo aviso. / We reserve the right to change specifications without prior notice. / Sujet technique et la conception de modifications sans préavis.

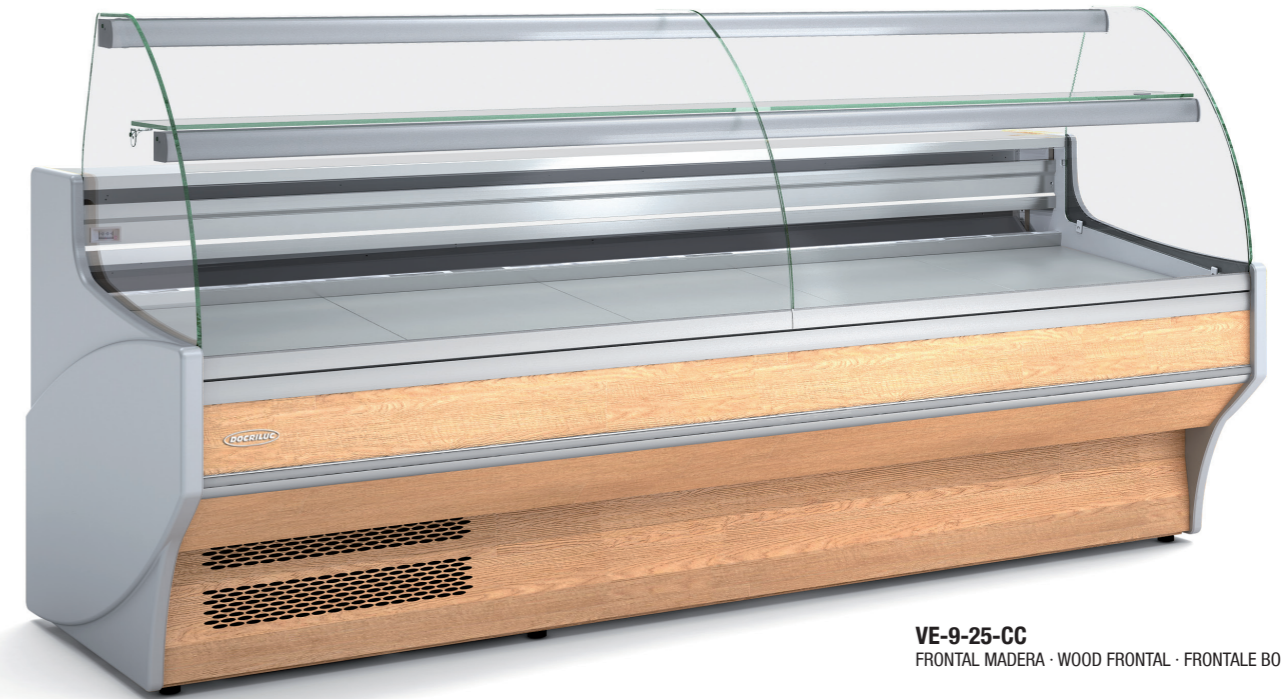

**VE-9-25-CC**  
FRONTAL MADERA · WOOD FRONTAL · FRONTALE BOIS

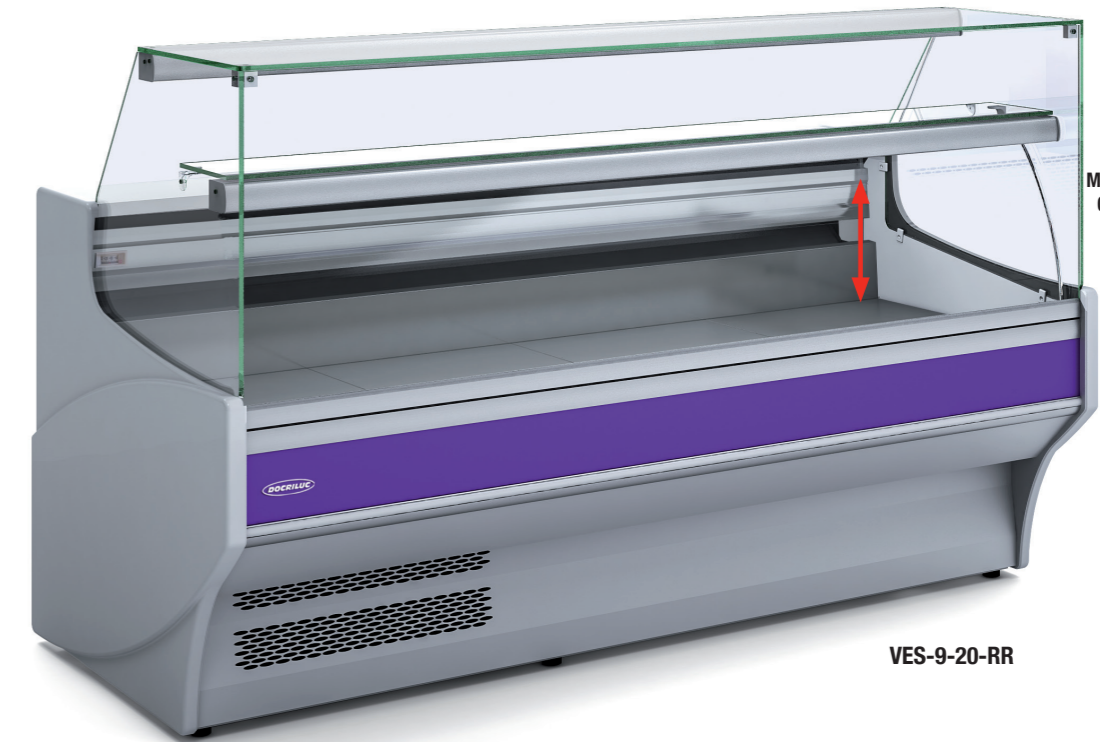

**VES-9-20-RR**

Mayor capacidad modelo VES  
Greater capacity model VES  
Plus capacité modèle VES

VE-9-10-RR <b>1.936 €</b>	VE-9-13-RR <b>2.165 €</b>	VE-9-15-RR <b>2.364 €</b>	VE-9-20-RR <b>2.804 €</b>	VE-9-25-RR <b>3.275 €</b>	VE-9-30-RR <b>3.924 €</b>
VES-9-10-RR <b>1.894 €</b>	VES-9-13-RR <b>2.082 €</b>	VES-9-15-RR <b>2.281 €</b>	VES-9-20-RR <b>2.679 €</b>	VES-9-25-RR <b>3.108 €</b>	VES-9-30-RR <b>3.663 €</b>
VE-9-10-CC <b>2.035 €</b>	VE-9-13-CC <b>2.244 €</b>	VE-9-15-CC <b>2.448 €</b>	VE-9-20-CC <b>2.924 €</b>	VE-9-25-CC <b>3.458 €</b>	VE-9-30-CC <b>4.143 €</b>
VES-9-10-CC <b>1.978 €</b>	VES-9-13-CC <b>2.165 €</b>	VES-9-15-CC <b>2.359 €</b>	VES-9-20-CC <b>2.794 €</b>	VES-9-25-CC <b>3.270 €</b>	VES-9-30-CC <b>3.945 €</b>



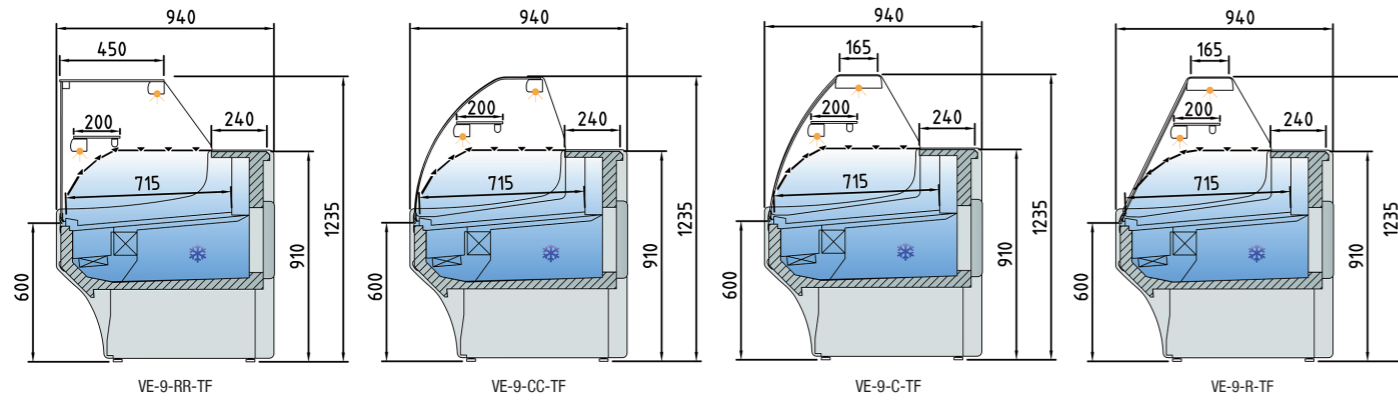

MODELOS CON RESERVA / RESERVE MODELS / RÉSERVE MODÈLES

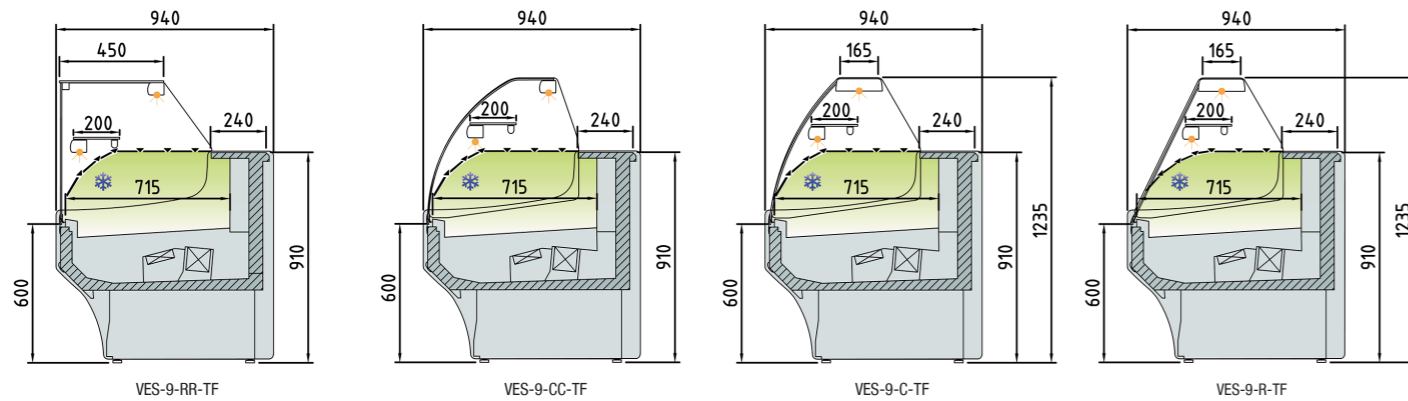

MODELOS SIN RESERVA / RESERVE WITHOUT MODELS / RÉSERVE SANS MODÈLES

Ver características técnicas en página 24 / See technical data in page 24 / Voir caractéristiques techniques page 24

Modelo Modél Modèle	Largo Length Longueur (mm)	Cámara VE Storage VE Stockage VE (m <sup>2</sup> )	Exposición Display Exposition (m <sup>2</sup> )	Puertas VE / VES Doors VE / VES Portes VE / VES (Uds)	Potencia frig. Frig. Power Puissance frig. (W)	Consumo Consumption Consommation (W)	Refrigerante Coolant Réfrigérant
VE / VES-9-10-TF	1055	0,33	0,65	1/0	522	419	R-452A
VE / VES-9-13-TF	1305	0,43	0,82	2/0	635	1071	R-452A
VE / VES-9-15-TF	1525	0,49	0,97	2/0	817	1107	R-452A
VE / VES-9-20-TF	2025	0,67	1,31	3/0	1096	1377	R-452A
VE / VES-9-25-TF	2525	0,84	1,65	4/0	1315	1433	R-452A
VE / VES-9-30-TF	2995	1,19	1,96	4/0	1315	1472	R-452A

230v 60Hz / 115v 60Hz. consultar - consult - consulter

OPCIONES · OPTIONS · OPTIONS

Modelo Model Modèle	1 decoración frontal / front decor / décoration frontal	2 Total decoración / Total decor / décoration total	Cierre Plexi Plexi slide Kit vitrage plexi	Cierre cortina Night blind Rideau nocturne	Iluminación led led lighting Éclairage Led	Neutra Neutral Neutre	Pre Instalación Remote Unit Groupe à distance
VE / VES-9-10-TF	55 €	270 €	92 €	82 €	41 €	-410 €	-123 €
VE / VES-9-13-TF	60 €	275 €	123 €	108 €	53 €	-461 €	-138 €
VE / VES-9-15-TF	65 €	280 €	138 €	123 €	61 €	-513 €	-148 €
VE / VES-9-20-TF	70 €	285 €	184 €	164 €	82 €	-615 €	-179 €
VE / VES-9-25-TF	75 €	290 €	230 €	205 €	102 €	-872 €	-205 €
VE / VES-9-30-TF	80 €	295 €	277 €	246 €	123 €	-995 €	-256 €

Características técnicas y constructivas sujetas a variación sin previo aviso. / We reserve the right to change specifications without prior notice. / Sujet technique et la conception de modifications sans préavis.

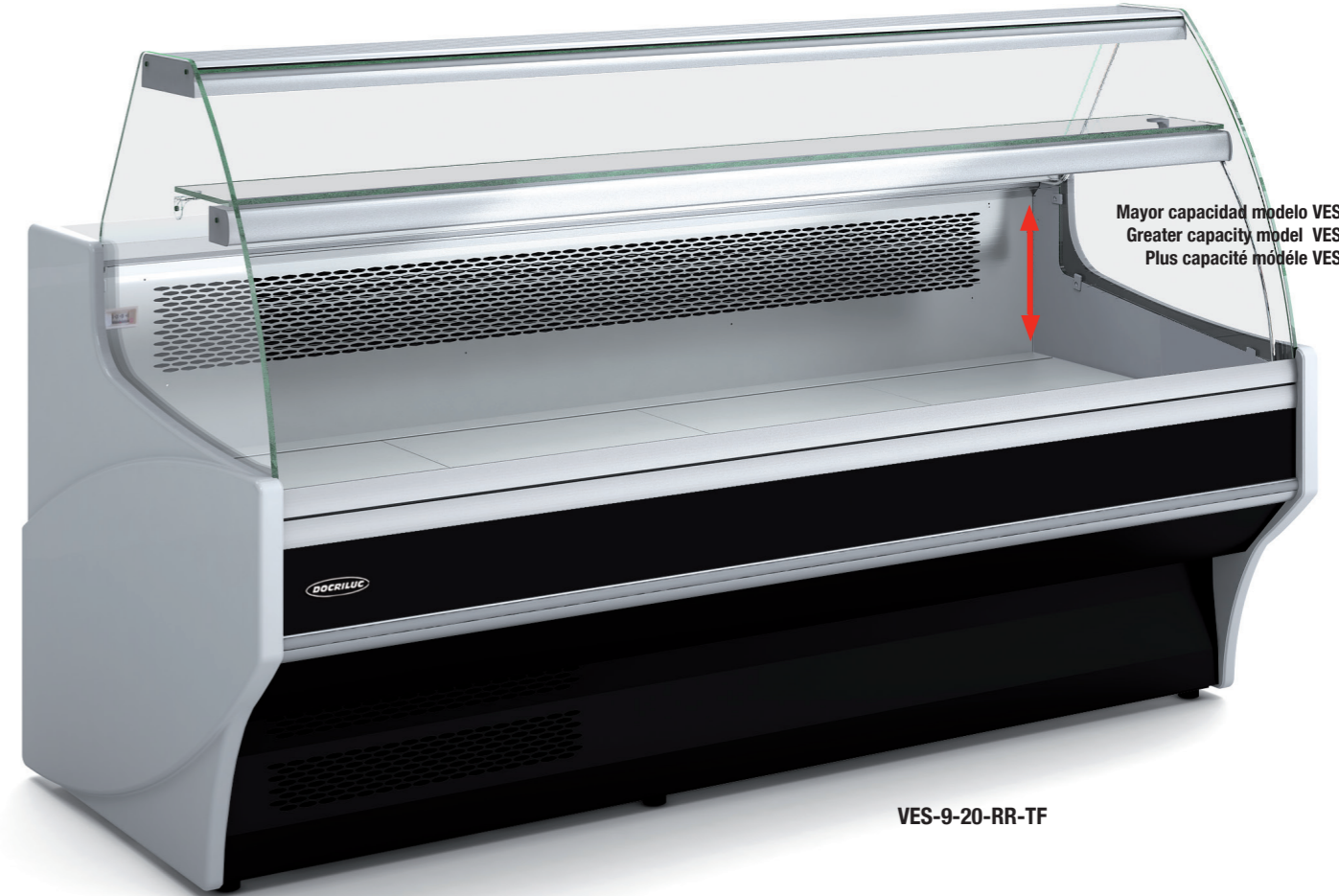

Mayor capacidad modelo VES  
Greater capacity model VES  
Plus capacité modèle VES

VES-9-20-RR-TF

VE-9-10-R-TF <b>1.897 €</b>	VE-9-13-R-TF <b>2.092 €</b>	VE-9-15-R-TF <b>2.302 €</b>	VE-9-20-R-TF <b>2.811 €</b>	VE-9-25-R-TF <b>3.288 €</b>	VE-9-30-R-TF <b>4.016 €</b>
VES-9-10-R-TF <b>1.856 €</b>	VES-9-13-R-TF <b>2.010 €</b>	VES-9-15-R-TF <b>2.220 €</b>	VES-9-20-R-TF <b>2.687 €</b>	VES-9-25-R-TF <b>3.124 €</b>	VES-9-30-R-TF <b>3.831 €</b>
VE-9-10-C-TF <b>2.077 €</b>	VE-9-13-C-TF <b>2.297 €</b>	VE-9-15-C-TF <b>2.528 €</b>	VE-9-20-C-TF <b>3.052 €</b>	VE-9-25-C-TF <b>3.565 €</b>	VE-9-30-C-TF <b>4.323 €</b>
VES-9-10-C-TF <b>2.036 €</b>	VES-9-13-C-TF <b>2.215 €</b>	VES-9-15-C-TF <b>2.441 €</b>	VES-9-20-C-TF <b>2.923 €</b>	VES-9-25-C-TF <b>3.395 €</b>	VES-9-30-C-TF <b>4.134 €</b>
VE-9-10-RR-TF <b>2.021 €</b>	VE-9-13-RR-TF <b>2.266 €</b>	VE-9-15-RR-TF <b>2.492 €</b>	VE-9-20-RR-TF <b>2.954 €</b>	VE-9-25-RR-TF <b>3.452 €</b>	VE-9-30-RR-TF <b>4.190 €</b>
VES-9-10-RR-TF <b>1.980 €</b>	VES-9-13-RR-TF <b>2.184 €</b>	VES-9-15-RR-TF <b>2.410 €</b>	VES-9-20-RR-TF <b>2.831 €</b>	VES-9-25-RR-TF <b>3.288 €</b>	VES-9-30-RR-TF <b>3.934 €</b>
VE-9-10-CC-TF <b>2.118 €</b>	VE-9-13-CC-TF <b>2.343 €</b>	VE-9-15-CC-TF <b>2.574 €</b>	VE-9-20-CC-TF <b>3.072 €</b>	VE-9-25-CC-TF <b>3.631 €</b>	VE-9-30-CC-TF <b>4.405 €</b>
VES-9-10-CC-TF <b>2.062 €</b>	VES-9-13-CC-TF <b>2.266 €</b>	VES-9-15-CC-TF <b>2.487 €</b>	VES-9-20-CC-TF <b>2.944 €</b>	VES-9-25-CC-TF <b>3.447 €</b>	VES-9-30-CC-TF <b>4.211 €</b>

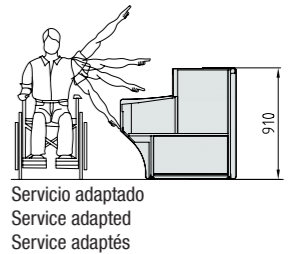
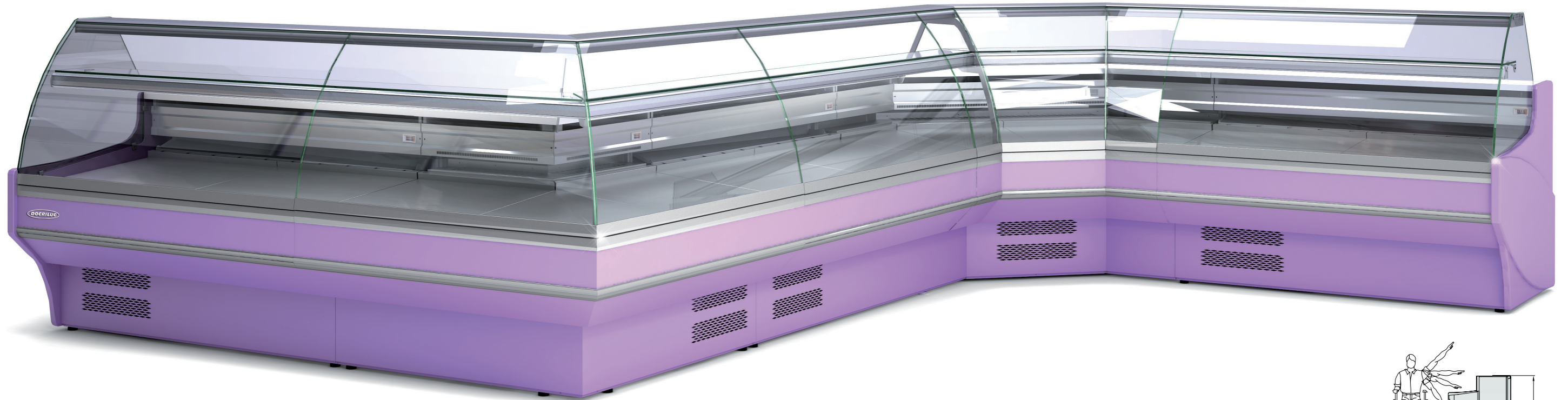

Ver características técnicas en página 24 / See technical data in page 24 / Voir caractéristiques techniques page 24

CARACTERÍSTICAS TÉCNICAS ÁNGULOS REFRIGERADOS	REFRIGERATED ANGLE TECHNICAL DATA	CARACTÉRISTIQUES TECHNIQUES DES ANGLES RÉFRIGÉRÉS
<ul style="list-style-type: none"> <li>Sistema de evaporación ventilado</li> <li>Modelos AP45 y AN45 neutros</li> <li>VES vitrina sin reserva</li> <li>VE vitrina con reserva</li> <li>C: Cristal curvo</li> <li>R: Cristal recto</li> <li>RR: Cristal doble recto</li> <li>Mismo precio para cristales C y RR</li> <li>Todos los modelos sin puerta de reserva</li> </ul>	<ul style="list-style-type: none"> <li>Ventilated evaporation system</li> <li>Neutral models AP45 y AN45</li> <li>VES without storage</li> <li>VE with storage</li> <li>C: Curved glass</li> <li>R: Flat glass</li> <li>RR: Double flat glass</li> <li>Same price for glass C and RR</li> <li>All doors models without reservation</li> </ul>	<ul style="list-style-type: none"> <li>Système d'évaporation ventilé</li> <li>Modèles AP45 y AN45 neutres</li> <li>VES sans stockage</li> <li>VE stockage</li> <li>C: Vitre bombée</li> <li>R: Vitre droit</li> <li>RR: Vitre double droit</li> <li>Même prix pour le verre C et RR</li> <li>Tous les modèles sans portes de réserve</li> </ul>

CARACTERÍSTICAS TÉCNICAS MUEBLES CAJAS	CASH NEUTRAL COUNTER DATA	CARACTÉRISTIQUES TECHNIQUES DES MEUBLE CAISSE
<ul style="list-style-type: none"> <li>Todos los modelos con cajón incorporado, estantes y enchufe excepto MCVE-9-AP90</li> <li>Decoración incluida</li> </ul>	<ul style="list-style-type: none"> <li>All models include drawer, shelves and plug except MCVE-9-AP90</li> <li>Decoration included</li> </ul>	<ul style="list-style-type: none"> <li>Tous les modèles avec tiroir incorporé, étagères et prise électrique sans MCVE-9-AP90</li> <li>Décoration inclus</li> </ul>

**ÁNGULOS NEGATIVOS / NEGATIVE ANGLES / NÉGATIF ANGLES**

VE-9-RN90 <b>4.473 €</b>	VE-9-AN90 <b>4.473 €</b>	VE-9N-AN45 <b>3.221 €</b>
VES-9-RN90 <b>4.329 €</b>	VES-9-AN90 <b>4.329 €</b>	VES-9N-AN45 <b>3.221 €</b>

**ÁNGULOS POSITIVOS / POSITIVE ANGLES / POSITIF ANGLES**

VE-9-RP90 <b>4.463 €</b>	VE-9-AP90 <b>4.463 €</b>	VE-9N-AP45 <b>3.180 €</b>
VES-9-RP90 <b>4.422 €</b>	VES-9-AP90 <b>4.422 €</b>	VES-9N-AP45 <b>3.180 €</b>

DETALLE DETAIL / DETAIL	MUEBLES CAJA NEUTROS EN ÁNGULO ANGULAR NEUTRAL CASH COUNTER / MEUBLE CAISSE NEUTRE ANGULAIRE	MUEBLES CAJA NEUTROS CASH NEUTRAL COUNTER / MEUBLE CAISSE NEUTRE
	MCVE-9-AP90 <b>1.744 €</b>	MCVE-9-8 <b>960 €</b>
	MCVE-9-AN90 <b>1.744 €</b>	MCVE-9-12 <b>1.056 €</b>

230v 60Hz / 115v 60Hz. consultar - consult - consulter

**OPCIONES · OPTIONS · OPTIONS**

Modelo	1 decoración frontal / front decor / décoration frontal	2 Total decoración / Total decor / décoration total	Puertas Cierre Plexi Plexi slide Doors Kit vitrage arrière coulissant plexi	Iluminación led led lighting Éclairage Led blanc	Cierre cortina Night blind Rideau nocturne	Neutra Neutral Neutre	Pre Instalación Remote Unit Groupe à distance
VE/VES-9-AP90	65 €	280 €	184 €	61 €	164 €	-513 €	-148 €
VE/VES-9-RP90	65 €	280 €	184 €	61 €	164 €	-513 €	-148 €
VE/VES-9-AN90	65 €	280 €	184 €	61 €	164 €	-513 €	-148 €
VE/VES-9-RN90	65 €	280 €	184 €	61 €	164 €	-513 €	-148 €
VE/VES-9-AP45	65 €	280 €	46 €	41 €	82 €	-	-
VE/VES-9-AN45	65 €	280 €	46 €	41 €	82 €	-	-

Características técnicas y constructivas sujetas a variación sin previo aviso / We reserve the right to change specifications without prior notice / Sujet technique et la conception de modifications sans préavis

Modelo Model Modèle	Largo Length Longueur (mm)	Alto Height Hauteur (mm)	Fondo Depth Profondeur (mm)	Cámara Storage Stockage (m <sup>3</sup> )	Exposición Display Exposition (m <sup>2</sup> )	Puertas Doors Portes (Uds)	Potencia frig. Frig. Power Puissance frig. (W)	Consumo Consumption Consommation (W)	Refrigerante Coolant Réfrigérant
VE/VES-9-AN90	1500	1230	1500	-	0,98	0	817	1122	R-452A
VE/VES-9-AP90	1325	1230	1325	-	1,04	0	817	1165	R-452A
VE/VES-9N-AN45	1090	1230	1060	-	0,48	0		3	
VE/VES-9N-AP45	1040	1230	940	-	0,53	0		3	
VE/VES-9-RN90	1352	1230	1352	-	1,01	0	635	961	R-452A
VE/VES-9-RP90	1335	1230	1335	-	1,32	0	635	1004	R-452A
MCVE-9-8	800	910	940						
MCVE-9-12	1200	910	940						
MCVE-9-AP90	1670	910	690						
MCVE-9-AN90	1638	910	825						

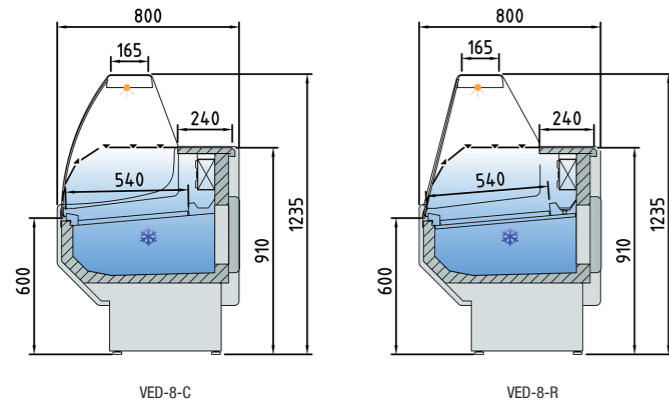

**VED-8-20-R**  
Estante intermedio adicional  
Additional intermediate shelf  
Étagère intermédiaire supplémentaires

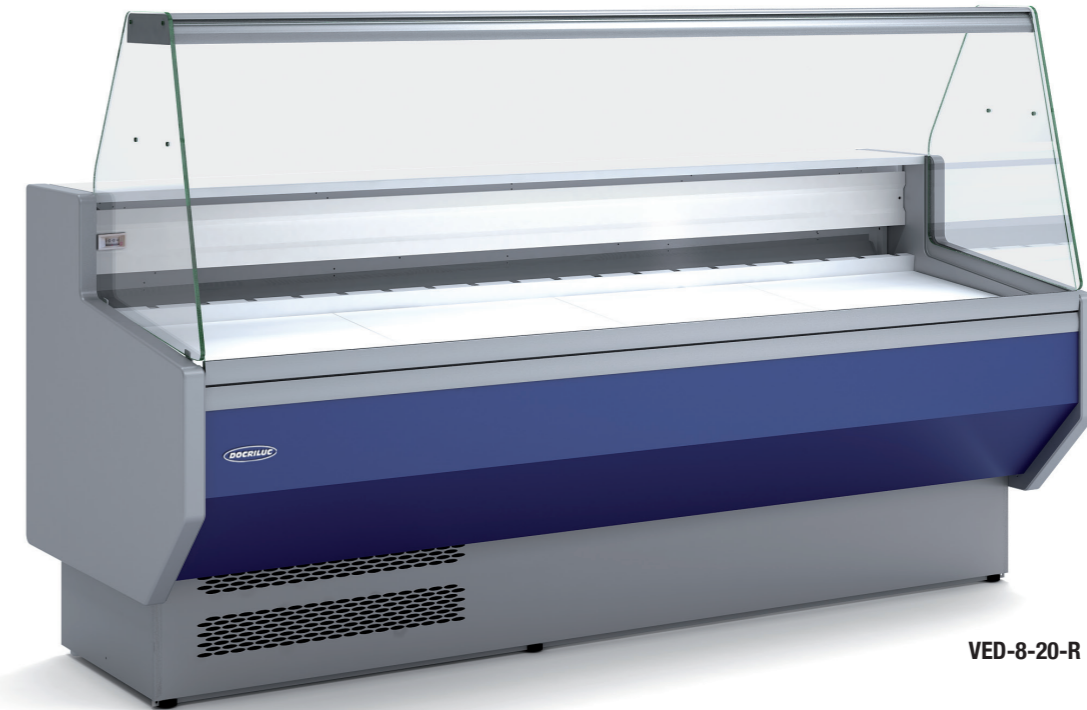

**VED-8-20-R**



**VED-8-20-C**

**CARACTERÍSTICAS TÉCNICAS**

- Exterior e interior en chapa de acero prepintada
- Plano exposición y protección evaporador en chapa acabado epoxi
- Costados de 40 mm en poliestireno inyectado
- Encimera en acero inox.
- Perfilera en aluminio lacado
- Estante de cristal intermedio, opcional
- Cristal frontal templado y abatible, dos versiones disponibles
- Iluminación estándar LED: encimera superior
- Aislamiento de poliuretano inyectado, densidad 40 Kg/m<sup>3</sup>, bajo GWP y cero efecto ODP
- Reserva refrigerada con puertas, hueco 440x270
- Evaporador estático
- Condensación ventilada
- Control electrónico de temperatura
- Indicador de temperatura
- Descarga automática
- Clase climática 4 (30°C 55% Hr) régimen M1 según UNE-EN ISO 23953-2
- Chasis en acero acabado epoxi
- Evaporación automática de serie

**TECHNICAL DATA**

- Exterior and interior steel sheet prepainted
- Exposure and protection evaporator in epoxy finish plate
- Sides polystyrene injected, 40 mm thickness
- Worktop in stainless steel
- Lacquered aluminum profiles
- Intermediate glass shelf, optional
- Toughened curved glass hinges forward, two versions available
- Lighting Standard LED on top surface
- Isolation of polyurethane, density 40 Kg / m<sup>3</sup>, low GWP and zero ODP effect
- Refrigerated under storage with doors 440x270free,
- Static evaporator
- Condensation ventilated
- Electronic temperature control
- Temperature Indicator
- Automatic Defrost
- Climatic class 4 (30 ° C 55% Hr) regime M1 according to UNE-EN ISO 23953-2
- Automatic evaporation as standard
- Chassis in epoxy finished steel

**CARACTÉRISTIQUES TECHNIQUES**

- Extérieur et intérieur en tôle d'acier prépeinte
- Plan d'exposition et protection de l'évaporateur en tôle, finition epoxi
- Côtés de 40mm en polystyrène injecté
- Plan de travail en acier inox.
- Profils en aluminium laqué
- Étagère intermédiaire en verre sur option
- Vitre frontale rabattable en verre trempé, deux versions disponibles.
- Eclairage standard LED : Plan de travail supérieur.
- Isolation en polyuréthane injecté, densité de 40 Kg / m<sup>3</sup>, faible GWP et aucun effet ODP.
- Réserve réfrigérée avec portes, espace de 440x270
- Evaporateur statique
- Condensateur ventilé
- Contrôle électronique de température
- Indicateur de température
- Dégivrage automatique
- Classe climatique 4 (30 ° C 55% Hr) régime M1 selon UNE-EN ISO 23953-2
- Évaporation automatique en standard
- Châssis en acier fini époxy

Modelo Model Modèle	Largo Length Longueur (mm)	Cámara Storage Stockage (m <sup>3</sup> )	Exposición Display Exposition (m <sup>2</sup> )	Puertas Doors Portes (Uds)	Potencia frig. Frig. Power Puissance frig. (W)	Consumo Consumption Consommation (W)	Refrigerante Coolant Réfrigérant
VED-8-10	1055	0,28	0,54	1	522	390	R-452A
VED-8-15	1525	0,43	0,8	2	635	1008	R-452A
VED-8-20	2025	0,57	1,08	3	817	1054	R-452A
VED-8-25	2525	0,72	1,36	4	1096	1344	R-452A

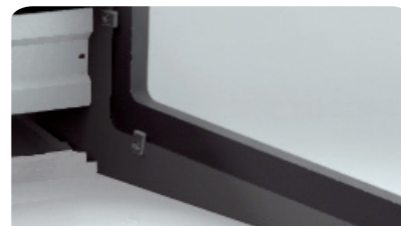

Detalle plano de exposición  
Detail exposure plane  
Detail plan d'exposition

230v 60Hz / 115v 60Hz. consultar - consult - consulter

**COLORES DECORACIÓN STANDARD / COLORS STANDARD DECORATION / COULEURS POUR LA DÉCORER STANDARD**



**OPCIONES · OPTIONS · OPTIONS**

Modelo Model Modèle	Estante cristal Glass shelf Étagère en verre	Plano de exposición en acero Stainless steel exposure Surface d'exposition en inox	Puertas correderas traseras Rear sliding doors Portes coulissantes arrière
VED-8-10	51 €	92 €	92 €
VED-8-15	71 €	138 €	138 €
VED-8-20	102 €	153 €	184 €
VED-8-25	123 €	230 €	230 €

Características técnicas y constructivas sujetas a variación sin previo aviso. / We reserve the right to change specifications without prior notice. / Sujet technique et la conception de modifications sans préavis.

VED-8-10-R <b>1.452 €</b>	VED-8-15-R <b>1.712 €</b>	VED-8-20-R <b>2.051 €</b>	VED-8-25-R <b>2.374 €</b>
VED-8-10-C <b>1.477 €</b>	VED-8-15-C <b>1.739 €</b>	VED-8-20-C <b>2.082 €</b>	VED-8-25-C <b>2.411 €</b>

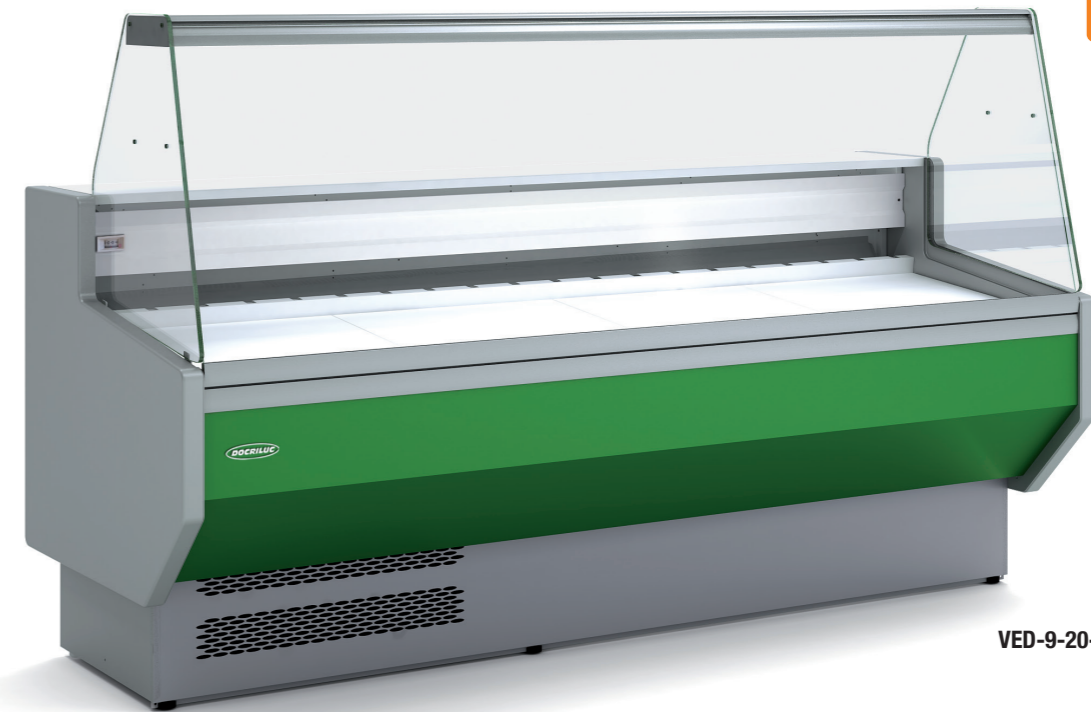
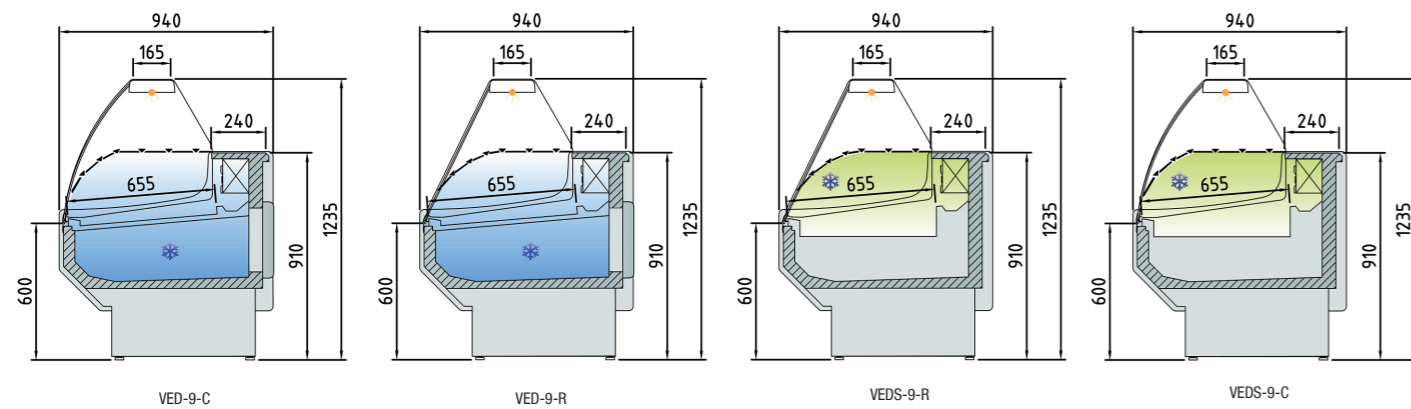

VED-9-20-R



VED-9-20-C

MODELOS CON RESERVA / RESERVE MODELS / RÉSERVE MODÈLES

MODELOS SIN RESERVA / RESERVE WITHOUT MODELS / RÉSERVE SANS MODÈLES

CARACTERÍSTICAS TÉCNICAS

- VED vitrinas con reserva
- VEDS vitrinas sin reserva
- Exterior e interior en chapa de acero prepintada
- Plano exposición y protección evaporador en chapa acabado epoxi
- Costados de 40 mm en poliestireno inyectado
- Encimera en acero inox
- Perfilera en aluminio lacado
- Estante de cristal intermedio, opcional
- Cristal frontal templado y abatible, dos versiones disponibles
- Iluminación estándar LED: encimera superior
- Aislamiento de poliuretano inyectado, densidad 40 Kg/m<sup>3</sup>, bajo GWP y cero efecto ODP
- Reserva refrigerada con puertas, hueco 440x270 (solo modelo VED)
- Evaporación estática
- Condensación ventilada
- Control electrónico de temperatura
- Indicador de temperatura
- Descarga automática
- Clase climática 4 (30°C 55% Hr) régimen M1 según UNE-EN ISO 23953-2
- Chasis en acero acabado epoxi
- Evaporación automática de serie

TECHNICAL DATA

- VED windows with booking
- VEDS cabinets without reservation
- Exterior and interior steel sheet prepainted
- Exposure and protection evaporator in epoxy finish plate
- Sides polystyrene injected, 40 mm thickness
- Worktop in stainless steel
- Lacquered aluminum profiles
- Intermediate glass shelf, optional
- Toughened curved glass hinges forward, two versions available
- Lighting Standard LED on top surface
- Isolation of polyurethane, density 40 Kg / m<sup>3</sup>, low GWP and zero ODP effect
- Refrigerated under storage with doors 440x270 (only model VED)
- Static evaporation
- Condensation ventilated
- Electronic temperature control
- Temperature Indicator
- Automatic Defrost
- Climatic class 4 (30 ° C 55% Hr) regime M1 according to UNE-EN ISO 23953-2
- Automatic evaporation as standard
- Chassis in epoxy finished steel

CARACTÉRISTIQUES TECHNIQUES

- Fenêtres VED avec réservation
- Armoires veds sans réserve
- Extérieur et intérieur en tôle d'acier prépeinte
- Plan d'exposition et protection de l'évaporateur en tôle, finition epoxi
- Côtés de 40mm en polystyrène injecté
- Plan de travail en acier inox
- Profils en aluminium laqué
- Étagère intermédiaire en verre sur option
- Vitre frontale rabattable en verre trempé, deux versions disponibles.
- Éclairage standard LED: Plan de travail supérieur.
- Isolation en polyuréthane injecté, densité de 40 Kg / m<sup>3</sup>, faible GWP et aucun effet ODP.
- Réserve réfrigérée avec portes, espace de 440x270 (solo modelé VED)
- Évaporation statiqué
- Condensateur ventilé
- Contrôle électronique de température
- Indicateur de température
- Dégivrage automatique
- Classe climatique 4 (30 ° C 55% Hr) régime M1 selon UNE-EN ISO 23953-2
- Évaporation automatique en standard
- Châssis en acier fini époxy

Modelo / Modèle	Largo / Length / Longueur (mm)	Cámara / Storage / Stockage (m <sup>3</sup> )	Exposición / Display / Exposition (m <sup>2</sup> )	Puertas / Doors / Portes (Uds)	Potencia frig. / Frig. Power / Puissance frig. (W)	Consumo / Consumption / Consommation (W)	Refrigerante / Coolant / Réfrigérant
VED / VEDS-9-10	1055	0,33	0,65	1/0	522	397	R-452A
VED / VEDS-9-15	1525	0,49	0,97	2/0	817	1068	R-452A
VED / VEDS-9-20	2025	0,67	1,31	3/0	817	1088	R-452A
VED / VEDS-9-25	2525	0,84	1,65	4/0	1096	1344	R-452A

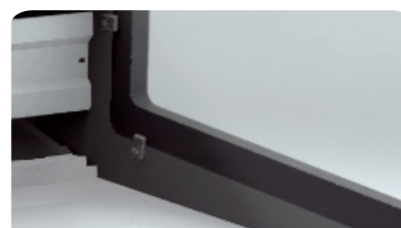

Detalle plano de exposición / Detail exposure plane / Detail plan d'exposition

230v 60Hz / 115v 60Hz. consultar - consult - consulter

COLORES DECORACIÓN STANDARD / COLORS STANDARD DECORATION / COULEURS POUR LA DÉCORER STANDARD



OPCIONES · OPTIONS · OPTIONS

Modelo / Model / Modèle	Estante cristal / Glass shelf / Étagère en verre	Plano de exposición en acero / Stainless steel exposure / Surface d'exposition en inox	Puertas correderas traseras / Rear sliding doors / Portes coulissantes arrière
VED / VEDS-9-10	51 €	92 €	92 €
VED / VEDS-9-15	71 €	138 €	138 €
VED / VEDS-9-20	102 €	153 €	184 €
VED / VEDS-9-25	123 €	230 €	230 €

Características técnicas y constructivas sujetas a variación sin previo aviso. / We reserve the right to change specifications without prior notice. / Sujet technique et la conception de modifications sans préavis.

VED-9-10-R <b>1.579 €</b>	VED-9-15-R <b>1.849 €</b>	VED-9-20-R <b>2.187 €</b>	VED-9-25-R <b>2.579 €</b>
VEDS-9-10-R <b>1.532 €</b>	VEDS-9-15-R <b>1.754 €</b>	VEDS-9-20-R <b>2.050 €</b>	VEDS-9-25-R <b>2.399 €</b>
VED-9-10-C <b>1.609 €</b>	VED-9-15-C <b>1.877 €</b>	VED-9-20-C <b>2.259 €</b>	VED-9-25-C <b>2.676 €</b>
VEDS-9-10-C <b>1.565 €</b>	VEDS-9-15-C <b>1.822 €</b>	VEDS-9-20-C <b>2.124 €</b>	VEDS-9-25-C <b>2.499 €</b>

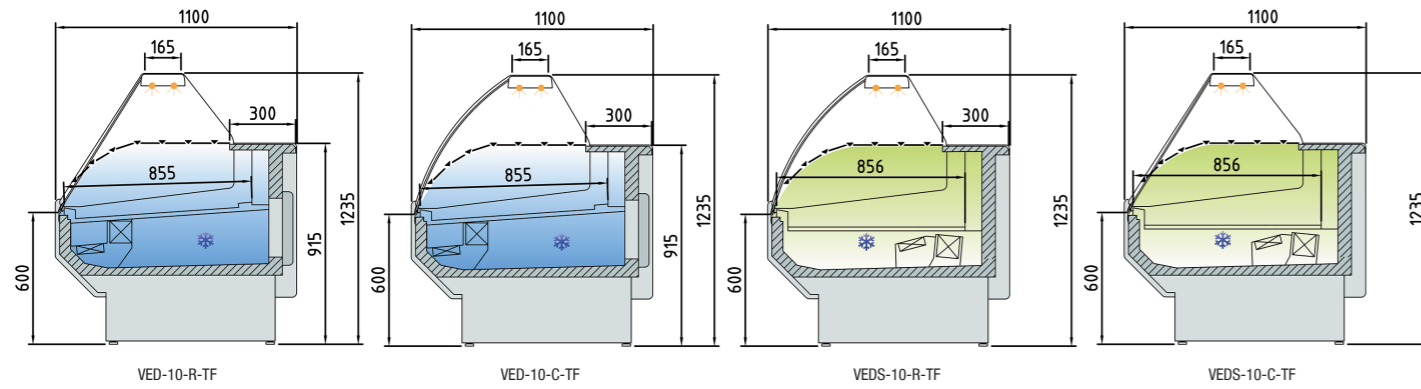

MODELOS CON RESERVA / RESERVE MODELS / RÉSERVE MODÈLES

MODELOS SIN RESERVA / RESERVE WITHOUT MODELS / RÉSERVE SANS MODÈLES

**CARACTERÍSTICAS TÉCNICAS**

- VED vitrinas con reserva
- VEDS vitrinas sin reserva
- Exterior e interior en chapa de acero prepintada
- Plano exposición y protección evaporador en chapa acabado epoxi
- Costados de 40 mm en poliestireno inyectado
- Encimera en acero inox
- Perfilera en aluminio lacado
- Estante de cristal intermedio, opcional
- Cristal frontal templado y abatible, dos versiones disponibles
- Iluminación estándar LED: encimera superior
- Aislamiento de poliuretano inyectado, densidad 40 Kg/m<sup>3</sup>, bajo GWP y cero efecto ODP
- Reserva refrigerada con puertas, hueco 440x270
- Evaporación ventilada
- Condensación ventilada
- Control electrónico de temperatura
- Indicador de temperatura
- Descarga automática
- Clase climática 4 (30 °C 55% Hr) régimen M1 según UNE-EN ISO 23953-2
- Chasis en acero acabado epoxi
- Evaporación automática de serie

**TECHNICAL DATA**

- VED windows with booking
- VEDS cabinets without reservation
- Exterior and interior steel sheet prepainted
- Exposure and protection evaporator in epoxy finish plate
- Sides polystyrene injected, 40 mm thickness
- Worktop in stainless steel
- Lacquered aluminum profiles
- Intermediate glass shelf, optional
- Toughened curved glass hinges forward, two versions available
- Lighting Standard LED on top surface
- Isolation of polyurethane, density 40 Kg / m<sup>3</sup>, low GWP and zero ODP effect
- Refrigerated under storage with doors 440x270
- Ventilated evaporation
- Condensation ventilated
- Electronic temperature control
- Temperature Indicator
- Automatic Defrost
- Climatic class 4 (30 ° C 55% Hr) regime M1 according to UNE-EN ISO 23953-2
- Automatic evaporation as standard
- Chassis in epoxy finished steel

**CARACTÉRISTIQUES TECHNIQUES**

- Fenêtres VED avec réservation
- Armoires veds sans réserve
- Extérieur et intérieur en tôle d'acier prépeinte
- Plan d'exposition et protection de l'évaporateur en tôle, finition epoxi
- Côtés de 40mm en polystyrène injecté
- Plan de travail en acier inox
- Profils en aluminium laqué
- Etagère intermédiaire en verre sur option
- Vitre frontale rabattable en verre trempé, deux versions disponibles.
- Eclairage standard LED: Plan de travail supérieur.
- Isolation en polyuréthane injecté, densité de 40 Kg / m<sup>3</sup>, faible GWP et aucun effet ODP.
- Réserve réfrigérée avec portes, espace de 440x270
- Évaporation ventilé
- Condensateur ventilé
- Contrôle électronique de température
- Indicateur de température
- Dégivrage automatique
- Classe climatique 4 (30 ° C 55% Hr) régime M1 selon UNE-EN ISO 23953-2
- Évaporation automatique en standard
- Châssis en acier fini epoxy

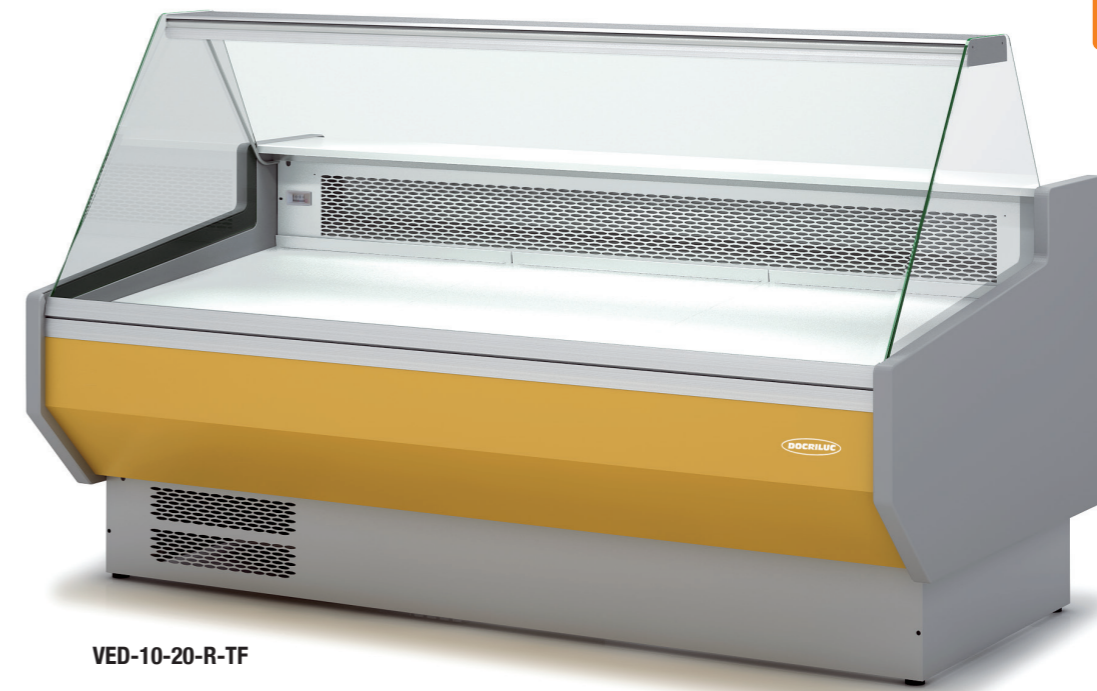

VED-10-20-R-TF

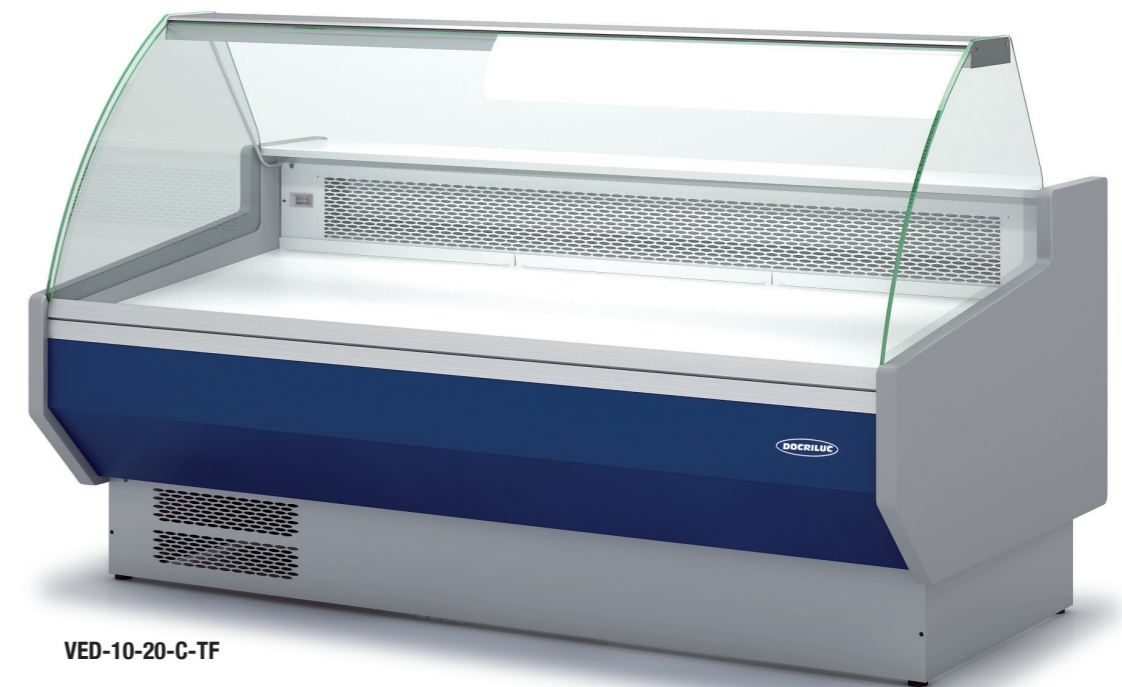

VED-10-20-C-TF

Modelo / Model / Modèle	Largo / Length / Longueur (mm.)	Cámara / Storage / Chambre (m <sup>3</sup> )	Exposición / Display / Exposition (m <sup>2</sup> )	Puertas / Doors / Portes (Uds)	Potencia Frig. / Frig Power / Puissance Frig. (W)	Consumo / Consumption / Consommation (W)	Refrig. / Coolant / Frigorigène
VED/VEDS-10-10-TF	1055	0,28	0,79	1/0	522	418	R-452A
VED/VEDS-10-15-TF	1525	0,43	1,17	2/0	817	1107	R-452A
VED/VEDS-10-20-TF	2025	0,57	1,58	3/0	1096	1377	R-452A
VED/VEDS-10-25-TF	2525	0,72	1,99	4/0	1315	1432	R-452A

230v 60Hz / 115v 60Hz. consultar - consult - consulter

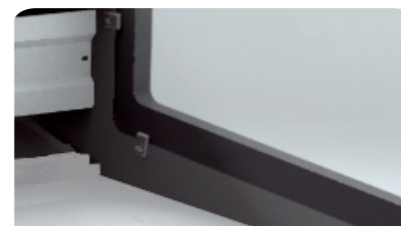

Detalle plano de exposición / Detail exposure plane / Detail plan d'exposition

**COLORES DECORACIÓN STANDARD / COLORS STANDARD DECORATION / COULEURS POUR LA DÉCORER STANDARD**



**OPCIONES · OPTIONS · OPTIONS**

Modelo / Model / Modèle	Estante cristal / Glass shelf / Etagère en verre	Plano de exposición en acero / Stainless steel exposure / Surface d'exposition en inox	Puertas correderas traseras / Rear sliding doors / Portes coulissantes arrière
VED / VEDS-10-10-TF	51 €	92 €	92 €
VED / VEDS-10-15-TF	71 €	138 €	138 €
VED / VEDS-10-20-TF	102 €	153 €	184 €
VED / VEDS-10-25-TF	123 €	230 €	230 €

Características técnicas y constructivas sujetas a variación sin previo aviso. / We reserve the right to change specifications without prior notice. / Sujet technique et la conception de modifications sans préavis.

VED-10-10-R-TF <b>2.040 €</b>	VED-10-15-R-TF <b>2.387 €</b>	VED-10-20-R-TF <b>2.829 €</b>	VED-10-25-R-TF <b>3.302 €</b>
VEDS-10-10-R-TF <b>1.992 €</b>	VEDS-10-15-R-TF <b>2.293 €</b>	VEDS-10-20-R-TF <b>2.754 €</b>	VEDS-10-25-R-TF <b>3.139 €</b>
VED-10-10-C-TF <b>2.145 €</b>	VED-10-15-C-TF <b>2.482 €</b>	VED-10-20-C-TF <b>2.976 €</b>	VED-10-25-C-TF <b>3.470 €</b>
VEDS-10-10-C-TF <b>2.098 €</b>	VEDS-10-15-C-TF <b>2.394 €</b>	VEDS-10-20-C-TF <b>2.839 €</b>	VEDS-10-25-C-TF <b>3.292 €</b>



6500K



RED FRESH

**CARACTERÍSTICAS TÉCNICAS**

- Exterior e interior en chapa de acero plastificada
- Plano exposición y encimera en acero inox. AISI-304
- Bandejas plano de exposición lisas, con escalón sobre demanda
- Costados de 40 mm en ABS inyectado
- Perfilera en aluminio anodizado.
- Paragolpes en la parte delantera
- Cristal frontal templado y abatible, cinco versiones disponibles
- Estante de cristal intermedio, opcional
- Iluminación estándar: encimera superior LED
- Aislamiento de poliuretano inyectado, densidad 40 Kg/m<sup>3</sup>, bajo GWP y cero efecto ODP
- Reserva refrigerada con puertas, hueco 440x270 (excepto modelo neutro y modelo sin reserva)
- Evaporador ventilado, estático opcional
- Condensación ventilada y evaporación automática de serie
- Control electrónico de temperatura
- Indicador de temperatura
- Descarche automático, opcional eléctrico
- Clase climática 4 (30°C 55% Hr) régimen M1 según UNE-EN ISO 23953-2
- Chasis en acero acabado epoxi
- Tensión de trabajo monofásica 220V 50Hz
- Modelo MC sin encimera y sin iluminación

**TECHNICAL DATA**

- Interior and exterior finish in plastic coated steel
- Display area and counter in stainless steel AISI-304
- Smooth deck for display area, stepped on demand
- Sides available in ABS injected, 40mm thick
- Anodised aluminium profiles
- Front rubber bumper
- Toughened curved glass hinges forward, five versions available
- Glass shelf non refrigerated, optional
- Standard lighting: top worktop LED
- 40 Kg/m<sup>3</sup> density polyurethane insulation, low GWP and zero ODP effect
- Refrigerated under storage with doors, 440x270 free (except neutral model and model without reservation)
- Ventilated evaporator, optional static evaporator
- Ventilated condensation and automatic defrost evaporation as standard
- Electronic temperature controller
- External thermometer
- Automatic defrost, electric as optional
- Climatic class 4 (30 ° C 55% Hr) regime M1 according to UNE-EN ISO 23953-2
- Working voltage single phase 220V 50Hz
- Chassis in epoxy finished steel
- Model MC without worktop and without illumination

**CARACTÉRISTIQUES TECHNIQUES**

- Extérieur et intérieur en acier plastifié.
- Surface d'exposition et plan de travail en inox. AISI-304
- Surface d'exposition lisse, possibilité double niveau sur demande
- Côtes en ABS thermoformé, épaisseur 40 mm.
- Profilés en aluminium anodise
- Pare-chocs en partie frontale
- Vitre droite ou bombée sécurit rabattable
- Étagère en verre non réfrigérée
- Lumière standard en partie haute LED
- Isolation en polyuréthane injecté sans CFC, densité 40Kg/m<sup>3</sup>
- Stockage réfrigéré, espace 440x270 (sauf modèle neutre et le modèle sans réserve)
- Evaporateur ventilé
- Condensation ventilé, évaporation automatique en standard
- Contrôle de température électronique
- Régulateur de température
- Dégivrage automatique, électrique en option
- Classe climatique 4 (30 ° C 55% Hr) régime M1 selon UNE-EN ISO 23953-2
- Tension de fonctionnement monphasé 220V 50Hz
- Châssis en acier fini époxy
- Modèle MC sans haut et sans éclairage

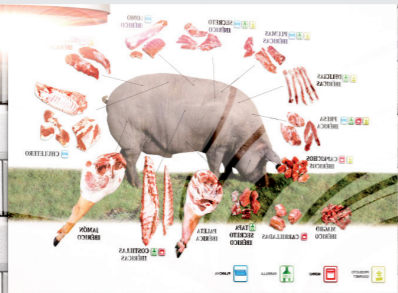

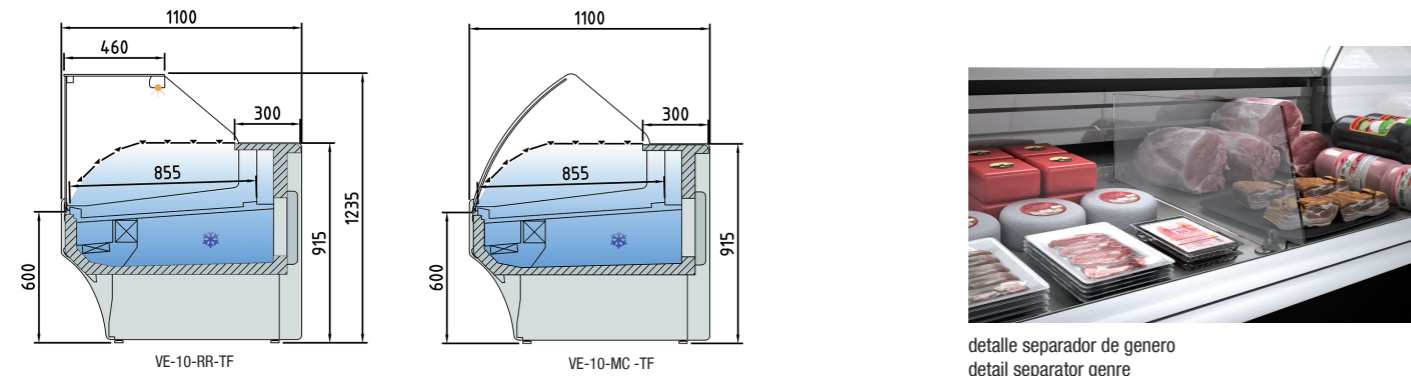
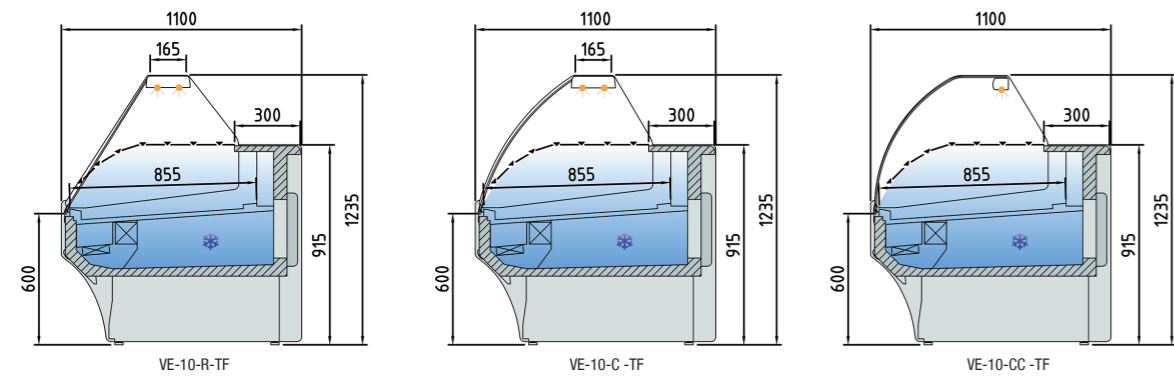

detalle separador de genero  
detail separator genre  
détail séparateur de genre

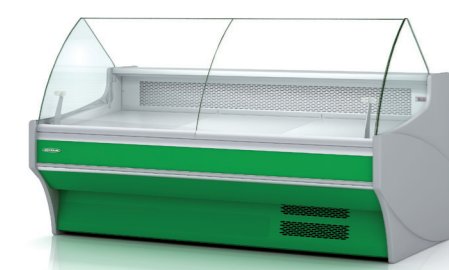

1 detalle cristal MC / MC glass detail / detail vitre MC

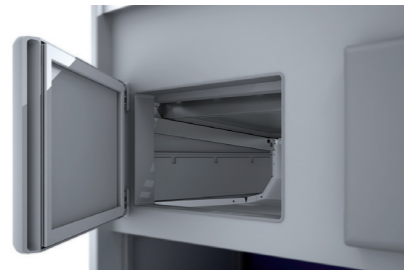

detalle reserva refrigerada  
Reserve refrigerated detail  
détail du livre réfrigérés



detalle cristal abatible  
detail folding glass  
détail le verre de pliage



**VE-10-20-C-TF**  
TOTAL LACADO · LACQUERED TOTAL · TOTAL LAQUÉ

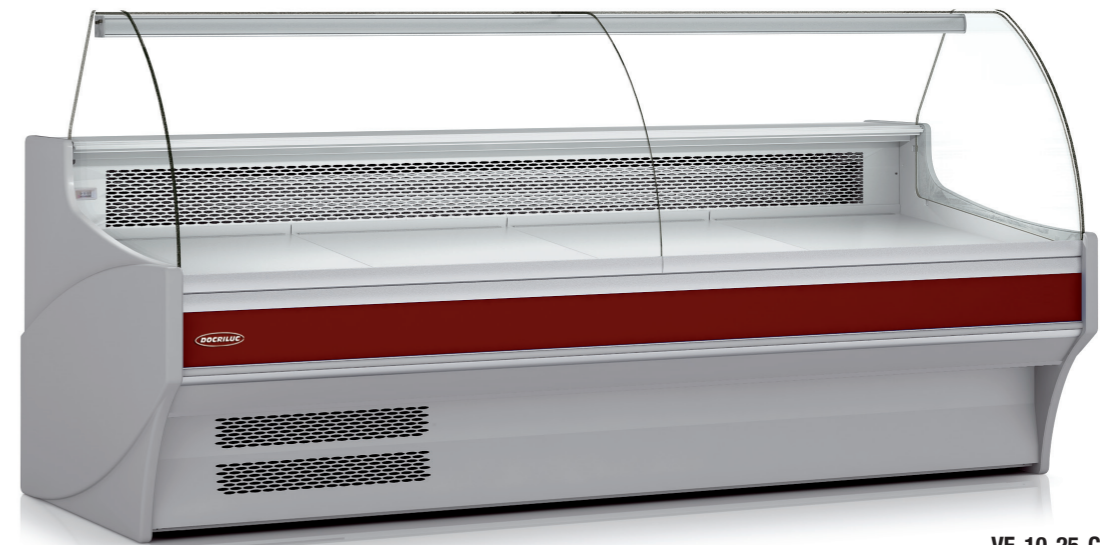

**VE-10-25-CC-TF**

Mismo precio para modelos estáticos y ventilados / Same price for static and ventilated models / Même prix pour les modèles statiques et ventilés  
Ver características técnicas en página 60 / See technical data in page 60 / Voir caractéristiques techniques page 60

Modelo Model Modèle	Largo Length Longueur (mm)	Cámara Storage Stockage (m <sup>3</sup> )	Exposición Display Exposition (m <sup>2</sup> )	Puertas Doors Portes (Uds)	Potencia frig. Frig. Power Puissance frig. (W)	Consumo Consumption Consommation (W)	Refrigerante Coolant Réfrigérant
VE-10-10-TF	1055	0,38	0,79	1	522	419	R-452A
VE-10-13-TF	1305	0,5	0,99	2	635	1037	R-452A
VE-10-15-TF	1525	0,58	1,17	2	817	1107	R-452A
VE-10-20-TF	2025	0,79	1,58	3	1096	1377	R-452A
VE-10-25-TF	2525	0,99	1,99	4	1315	1433	R-452A
VE-10-30-TF	2995	1,25	2,37	4	1315	1472	R-452A

230v 60Hz / 115v 60Hz. consultar - consult - consulter

Modelo Model Modèle	OPCIONES · OPTIONS · OPTIONS		Cierre Plexi Plexi slide Kit vitrage plexi	Iluminación led extra Extra led lighting Éclairage Led extra	Iluminación led rosa Pink led lighting Éclairage Led rose	Cierre cortina Night blind Rideau nocturne	Estante cristal Glass shelf Plateau en verre	Neutra Neutral Neutre	Pre Instalación Remote Unit Groupe à distance
	1 decoración frontal / front decor / décoration frontal	2 Total decoración / Total decor / décoration total							
VE-10-10-TF	55 €	270 €	92 €	41 €	41 €	82 €	51 €	-410 €	-123 €
VE-10-13-TF	60 €	275 €	123 €	53 €	53 €	108 €	61 €	-461 €	-138 €
VE-10-15-TF	65 €	280 €	138 €	61 €	61 €	123 €	71 €	-513 €	-148 €
VE-10-20-TF	70 €	285 €	184 €	82 €	82 €	164 €	102 €	-615 €	-179 €
VE-10-25-TF	75 €	290 €	230 €	102 €	102 €	205 €	123 €	-872 €	-205 €
VE-10-30-TF	80 €	295 €	277 €	123 €	123 €	246 €	143 €	-995 €	-256 €

Características técnicas y constructivas sujetas a variación sin previo aviso. / We reserve the right to change specifications without prior notice. / Sujet technique et la conception de modifications sans préavis.

VE-10-10-C-TF 2.329 €	VE-10-13-C-TF 2.724 €	VE-10-15-C-TF 2.903 €	VE-10-20-C-TF 3.452 €	VE-10-25-C-TF 4.011 €	VE-10-30-C-TF 4.714 €
VE-10-10-R-TF 2.236 €	VE-10-13-R-TF 2.559 €	VE-10-15-R-TF 2.780 €	VE-10-20-R-TF 3.211 €	VE-10-25-R-TF 3.729 €	VE-10-30-R-TF 4.499 €
VE-10-10-CC-TF 2.421 €	VE-10-13-CC-TF 2.677 €	VE-10-15-CC-TF 3.036 €	VE-10-20-CC-TF 3.483 €	VE-10-25-CC-TF 4.037 €	VE-10-30-CC-TF 4.909 €
VE-10-10-MC-TF 2.236 €	VE-10-13-MC-TF 2.559 €	VE-10-15-MC-TF 2.780 €	VE-10-20-MC-TF 3.211 €	VE-10-25-MC-TF 3.729 €	VE-10-30-MC-TF 4.499 €
VE-10-10-RR-TF 2.329 €	VE-10-13-RR-TF 2.724 €	VE-10-15-RR-TF 2.903 €	VE-10-20-RR-TF 3.452 €	VE-10-25-RR-TF 4.011 €	VE-10-30-RR-TF 4.714 €

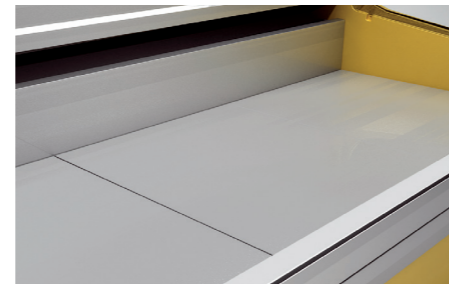
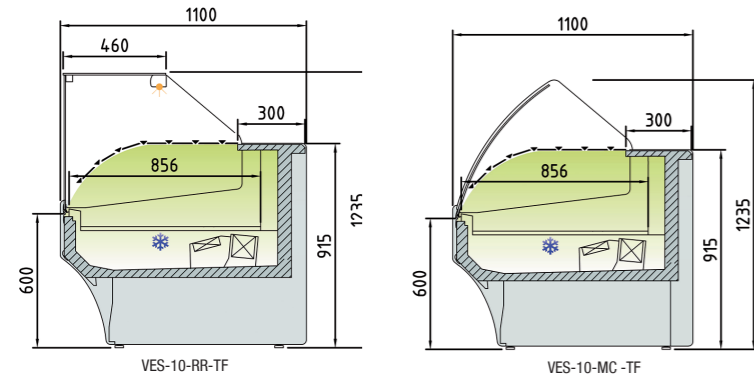
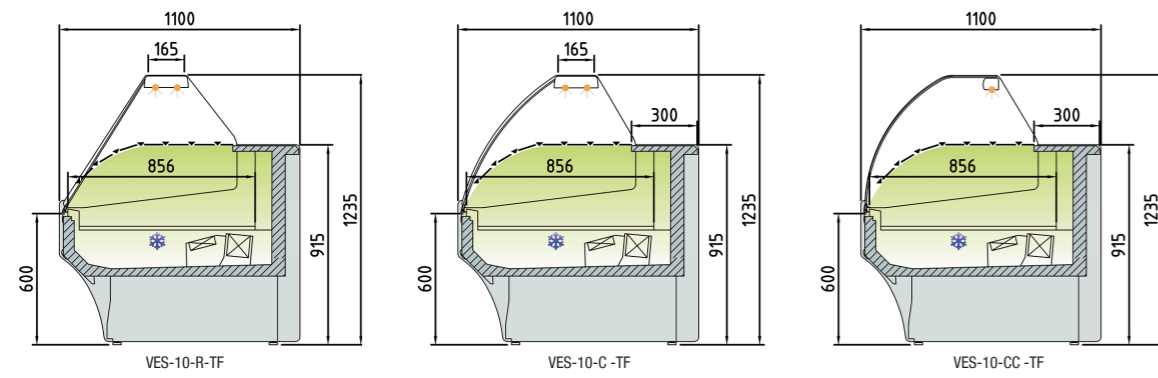

detalle modelo estático  
detail exposure plane  
detail plan d'exposition



detalle periferia anodizada  
detail anodised profiles  
profilis anodisés détail



2 lacado / lacquered / laqué

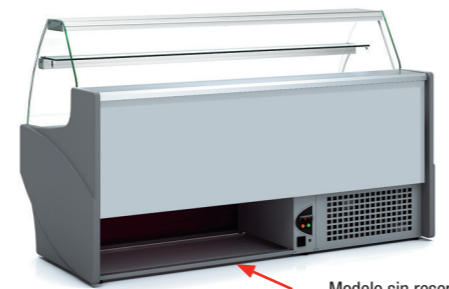

Modelo sin reserva  
Model without reservation  
Modèle sans réserve

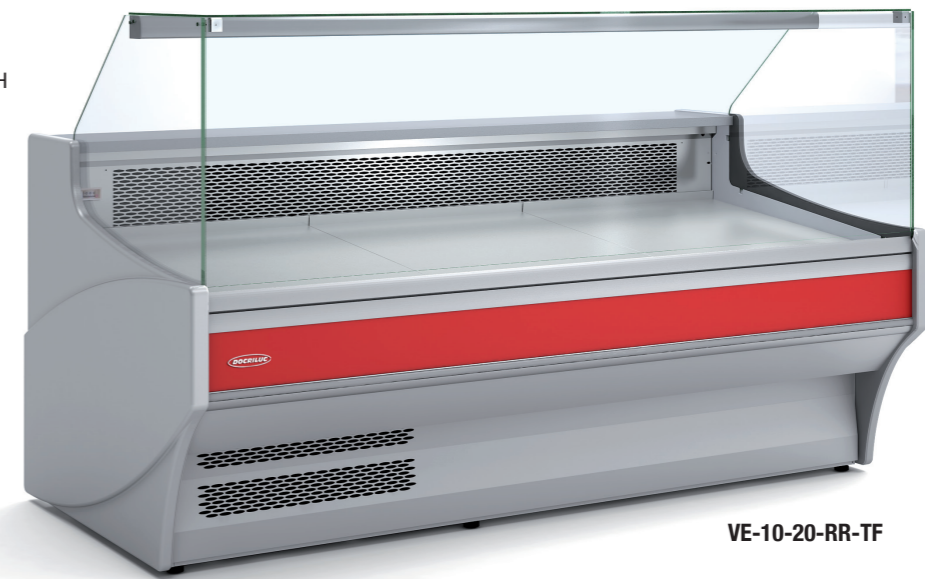

VE-10-20-RR-TF

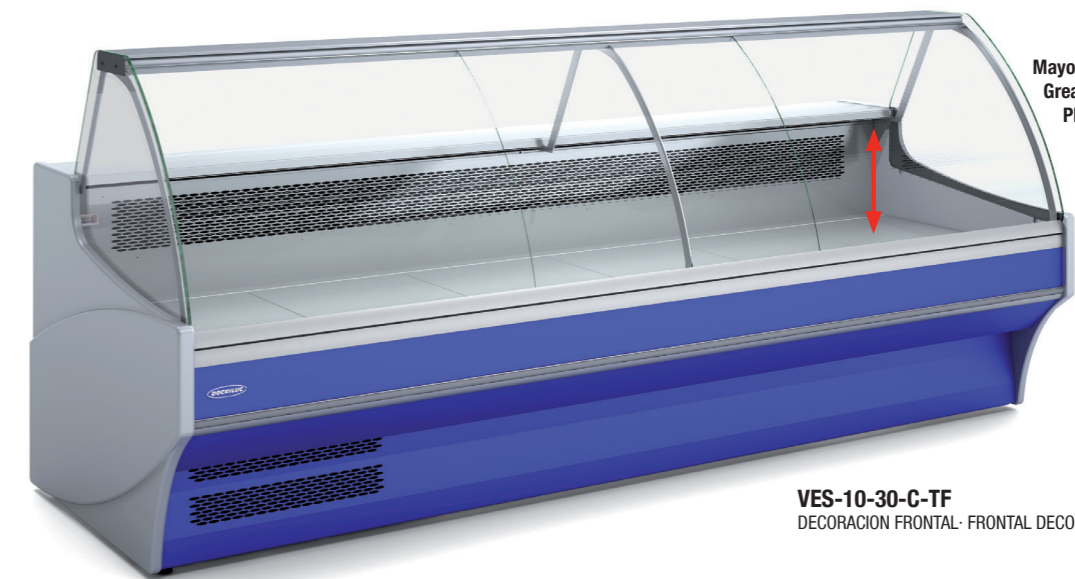

VES-10-30-C-TF

DECORACION FRONTAL · FRONTAL DECORATION · FRONTALE DECOR

Mayor capacidad modelo VES  
Greater capacity model VES  
Plus capacité modèle VES

Ver características técnicas en página 60 / See technical data in page 60 / Voir caractéristiques techniques page 60

Modelo Model Modèle	Largo Length Longueur (mm)	Cámara Storage Stockage (m³)	Exposición Display Exposition (m²)	Puertas Doors Portes (Uds)	Potencia frig. Frig. Power Puissance frig. (W)	Consumo Consumption Consommation (W)	Refrigerante Coolant Réfrigérant
VES-10-10-TF	1055	-	0,79	0	522	419	R-452A
VES-10-13-TF	1305	-	0,99	0	635	1037	R-452A
VES-10-15-TF	1525	-	1,17	0	817	1107	R-452A
VES-10-20-TF	2025	-	1,58	0	1096	1377	R-452A
VES-10-25-TF	2525	-	1,99	0	1315	1433	R-452A
VES-10-30-TF	2995	-	2,37	0	1315	1472	R-452A

230v 60Hz / 115v 60Hz. consultar - consult - consulter

Modelo Model Modèle	OPCIONES · OPTIONS · OPTIONS		Estática Static Statique	Cierre Plexi Plexi slide Kit vitrage plexi	Iluminación led extra rosa Extra led lighting pink Éclairage Led extra rose	Iluminación led extra blanco Extra led lighting white Éclairage Led extra blanc	Cierre cortina Night blind Rideau nocturne	Estante cristal Glass shelf Plateau en verre	Neutra Neutral Neutre	Pre Instalación Remote Unit Groupe à distance
	1 decoración frontal / front decor / décoration frontal	2 Total decoración / Total decor / décoration total								
VES-10-10-TF	55 €	270 €	-235 €	92 €	41 €	41 €	82 €	51 €	-410 €	-123 €
VES-10-13-TF	60 €	275 €	-246 €	123 €	53 €	53 €	108 €	61 €	-461 €	-138 €
VES-10-15-TF	65 €	280 €	-256 €	138 €	61 €	61 €	123 €	71 €	-513 €	-148 €
VES-10-20-TF	70 €	285 €	-277 €	184 €	82 €	82 €	164 €	102 €	-615 €	-179 €
VES-10-25-TF	75 €	290 €	-297 €	230 €	102 €	102 €	205 €	123 €	-872 €	-205 €
VES-10-30-TF	80 €	295 €	-318 €	277 €	123 €	123 €	246 €	143 €	-995 €	-256 €

Características técnicas y constructivas sujetas a variación sin previo aviso. / We reserve the right to change specifications without prior notice. / Sujet technique et la conception de modifications sans préavis.

VES-10-10-C-TF	2.272 €	VES-10-13-C-TF	2.647 €	VES-10-15-C-TF	2.831 €	VES-10-20-C-TF	3.344 €	VES-10-25-C-TF	3.852 €	VES-10-30-C-TF	4.534 €
VES-10-10-R-TF	2.195 €	VES-10-13-R-TF	2.477 €	VES-10-15-R-TF	2.698 €	VES-10-20-R-TF	3.088 €	VES-10-25-R-TF	3.560 €	VES-10-30-R-TF	4.319 €
VES-10-10-CC-TF	2.380 €	VES-10-13-CC-TF	2.636 €	VES-10-15-CC-TF	2.954 €	VES-10-20-CC-TF	3.360 €	VES-10-25-CC-TF	3.873 €	VES-10-30-CC-TF	4.745 €
VES-10-10-MC-TF	2.195 €	VES-10-13-MC-TF	2.477 €	VES-10-15-MC-TF	2.698 €	VES-10-20-MC-TF	3.088 €	VES-10-25-MC-TF	3.560 €	VES-10-30-MC-TF	4.319 €
VES-10-10-RR-TF	2.272 €	VES-10-13-RR-TF	2.647 €	VES-10-15-RR-TF	2.831 €	VES-10-20-RR-TF	3.344 €	VES-10-25-RR-TF	3.852 €	VES-10-30-RR-TF	4.534 €



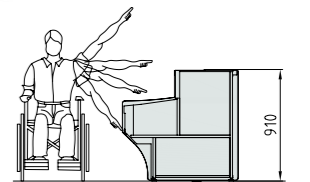
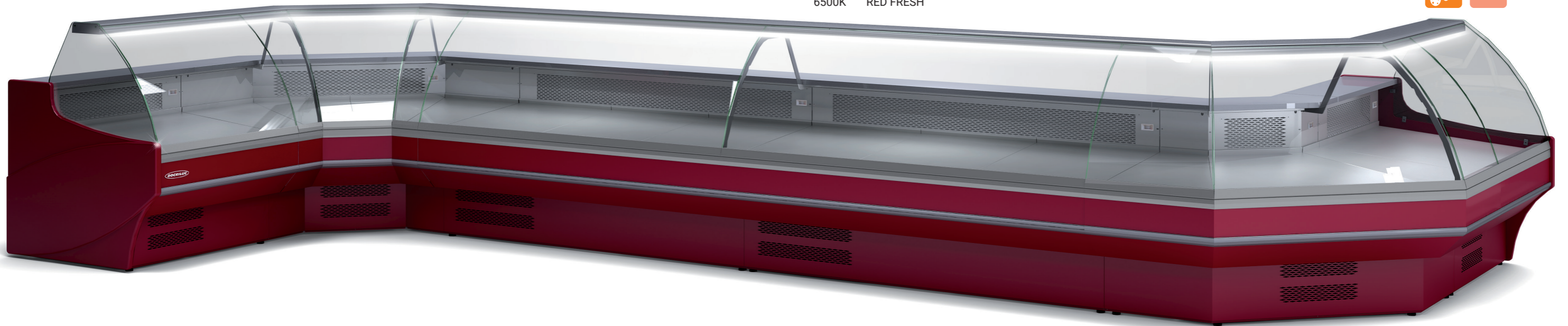

Servicio adaptado  
Service adapted  
Service adaptés

Ver características técnicas en página 60 / See technical data in page 60 / Voir caractéristiques techniques page 60

**CARACTERÍSTICAS TÉCNICAS ÁNGULOS REFRIGERADOS**

- Sistema de evaporación ventilado
- Modelos AP45 y AN45 neutros
- VES vitrina sin reserva
- VE vitrina con reserva
- **C:** Cristal curvo
- **R:** Cristal recto
- **MC:** Cristal medio
- Mismo precio para cristales **C, RR y MC**
- Todos los modelos sin puerta de reserva

**REFRIGERATED ANGLE TECHNICAL DATA**

- Ventilated evaporation system
- Neutral models AP45 y AN45
- VES without storage
- VE with storage
- **C:** Curved glass
- **R:** Flat glass
- **MC:** Half glass
- Same price for glass **C, RR and MC**
- All door models without reservation

**CARACTÉRISTIQUES TECHNIQUES DES ANGLES RÉFRIGÉRÉS**

- Système d'évaporation ventilé
- Modèles AP45 y AN45 neutros
- VES sans stockage
- VE stockage
- **C:** Vitre bombée
- **R:** Vitre droit
- **MC:** Vitre moyenne
- Même prix pour le verre **C, RR et MC**
- Tous les modèles sans portes de réserve

**CARACTERÍSTICAS TÉCNICAS MUEBLES CAJAS**

- Todos los modelos con cajón incorporado, estantes y enchufe excepto MCVE-10-AP90
- Decoración incluida

**CASH NEUTRAL COUNTER DATA**

- All models include drawer, shelves and plug except MCVE-10-AP90
- Decoration included

**CARACTÉRISTIQUES TECHNIQUES DES MEUBLE CAISSE**

- Tous les modèles avec tiroir incorporé, étagères et prise électrique sans MCVE-10-AP90
- Décoration inclus

**ÁNGULOS NEGATIVOS / NEGATIVE ANGLES / NÉGATIF ANGLES**

	<b>VE-10-RN90</b> 4.611 €		<b>VE-10-AN90</b> 4.611 €		<b>VE-10N-AN45</b> 3.303 €
	<b>VES-10-RN90</b> 4.468 €		<b>VES-10-AN90</b> 4.468 €		<b>VES-10N-AN45</b> 3.303 €

**ÁNGULOS POSITIVOS / POSITIVE ANGLES / POSITIF ANGLES**

	<b>VE-10-RP90</b> 4.575 €		<b>VE-10-AP90</b> 4.575 €		<b>VE-10N-AP45</b> 3.231 €
	<b>VES-10-RP90</b> 4.534 €		<b>VES-10-AP90</b> 4.534 €		<b>VES-10N-AP45</b> 3.231 €

**DETALLE  
DETAIL / DETAIL**



**MUEBLES CAJA NEUTROS EN ÁNGULO  
ANGULAR NEUTRAL CASH COUNTER / MEUBLE CAISSE NEUTRE ANGULAIRE**

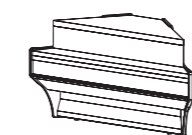

MCVE-10-AP90 1.795 €

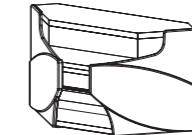

MCVE-10-AN90 1.795 €

**MUEBLES CAJA NEUTROS  
CASH NEUTRAL COUNTER / MEUBLE CAISSE NEUTRE**

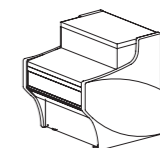

MCVE-10-8 1.231 €

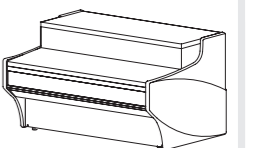

MCVE-10-12 1.354 €

230v 60Hz / 115v 60Hz. consultar - consult - consulter

**OPCIONES · OPTIONS · OPTIONS**

Modelo	1 decoración frontal / front decor / décoration frontal	2 Total decoración / Total decor / décoration total	Puertas Cierre Plexi Plexi slide Doors Kit vitrage arrière coulissant plexi	Iluminación led blanco White led lighting Éclairage Led blanc	Cierre cortina Night blind Rideau nocturne	Neutra Neutral Neutre	Pre Instalación Remote Unit Groupe à distance
VE/VES-10-AP90	65 €	280 €	184 €	61 €	164 €	-513 €	-148 €
VE/VES-10-RP90	65 €	280 €	184 €	61 €	164 €	-513 €	-148 €
VE/VES-10-AN90	65 €	280 €	184 €	61 €	164 €	-513 €	-148 €
VE/VES-10-RN90	65 €	280 €	184 €	61 €	164 €	-513 €	-148 €
VE/VES-10-AP45	65 €	280 €	46 €	41 €	82 €	-	-
VE/VES-10-AN45	65 €	280 €	46 €	41 €	82 €	-	-

Características técnicas y constructivas sujetas a variación sin previo aviso / We reserve the right to change specifications without prior notice / Sujet technique et la conception de modifications sans préavis

Modelo Model Modèle	Largo Length Longueur (mm)	Alto Height Hauteur (mm)	Fondo Depth Profondeur (mm)	Cámara Storage Stockage (m³)	Exposición Display Exposition (m²)	Puertas Doors Portes (Uds)	Potencia frig. Frig. Power Puissance frig. (W)	Consumo Consumption Consommation (W)	Refrigerante Coolant Réfrigérant
VE/VES-10-AN90	1500	1230	1500	-	0,98	0	817	1122	R-452A
VE/VES-10-AP90	1325	1230	1325	-	1,04	0	817	1165	R-452A
VE/VES-10N-AN45	1090	1230	1060	-	0,48	0		3	
VE/VES-10N-AP45	1040	1230	940	-	0,53	0		3	
VE/VES-10-RN90	1352	1230	1352	-	1,01	0	635	961	R-452A
VE/VES-10-RP90	1335	1230	1335	-	1,32	0	635	1004	R-452A
MCVE-10-8	800	910	1100						
MCVE-10-12	1200	910	1100						
MCVE-10-AP90	1890	910	800						
MCVE-10-AN90	1865	910	940						

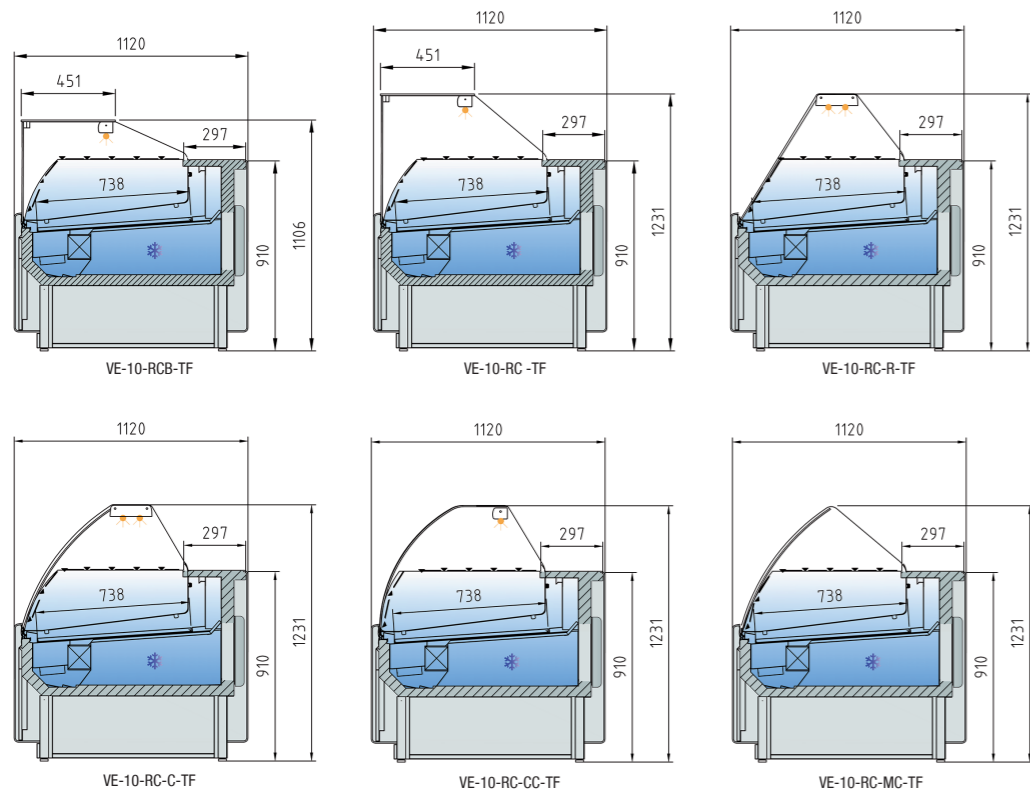

1 detalle cristal MC / MC glass detail / detail vitre MC

detalle reserva refrigerada  
Reserve refrigerated detail  
détail du livre réfrigérés

detalle cristal abatible  
detail folding glass  
détail du verre de pliage

Ver características técnicas en página 60 / See technical data in page 60 / Voir caractéristiques techniques page 60

Modelo Model Modèle	Largo Length Longueur (mm)	Cámara Storage Stockage (m³)	Exposición Display Exposition (m²)	Puertas Doors Portes (Uds)	Potencia frig. Frig. Power Puissance frig. (W)	Consumo Consumption Consommation (W)	Refrigerante Coolant Réfrigérant
VE-10-10-RC-TF	1055	0,38	0,79	1	522	419	R-452A
VE-10-13-RC-TF	1305	0,5	0,99	2	635	1037	R-452A
VE-10-15-RC-TF	1525	0,58	1,17	2	817	1107	R-452A
VE-10-20-RC-TF	2025	0,79	1,58	3	1096	1377	R-452A
VE-10-25-RC-TF	2525	0,99	1,99	4	1315	1433	R-452A
VE-10-30-RC-TF	2995	1,25	2,37	4	1315	1472	R-452A

230v 60Hz / 115v 60Hz. consultar - consult - consulter

Modelo Model Modèle	OPCIONES · OPTIONS · OPTIONS		Cierre Plexi Plexi slide Kit vitrage plexi	Iluminación led led lighting Éclairage Led	Iluminación led rosa Pink led lighting Éclairage Led rose	Cierre cortina Night blind Rideau nocturne	Estante cristal Glass shelf Plateau en verre	Neutra Neutral Neutre	Pre Instalación Remote Unit Groupe à distance
	1 decoración frontal / front decor / décoration frontal	2 Total decoración / Total decor / décoration total							
VE-10-10-RC-TF	55 €	270 €	92 €	41 €	41 €	82 €	51 €	-410 €	-123 €
VE-10-13-RC-TF	60 €	275 €	123 €	53 €	53 €	108 €	61 €	-461 €	-138 €
VE-10-15-RC-TF	65 €	280 €	138 €	61 €	61 €	123 €	71 €	-513 €	-148 €
VE-10-20-RC-TF	70 €	285 €	184 €	82 €	82 €	164 €	102 €	-615 €	-179 €
VE-10-25-RC-TF	75 €	290 €	230 €	102 €	102 €	205 €	123 €	-872 €	-205 €
VE-10-30-RC-TF	80 €	295 €	277 €	123 €	123 €	246 €	143 €	-995 €	-256 €

Características técnicas y constructivas sujetas a variación sin previo aviso. / We reserve the right to change specifications without prior notice. / Sujet technique et la conception de modifications sans préavis.

**VITRINA EXPOSITORA MODULAR VE-10-RC-TF CON RESERVA**

SERVE OVER COUNTER MODULAR VE-10-RC-TF LINE RESERVATION WITH · VITRINE SERIE VE-10-RC-TF GAMME AVEC RÉSERVATION

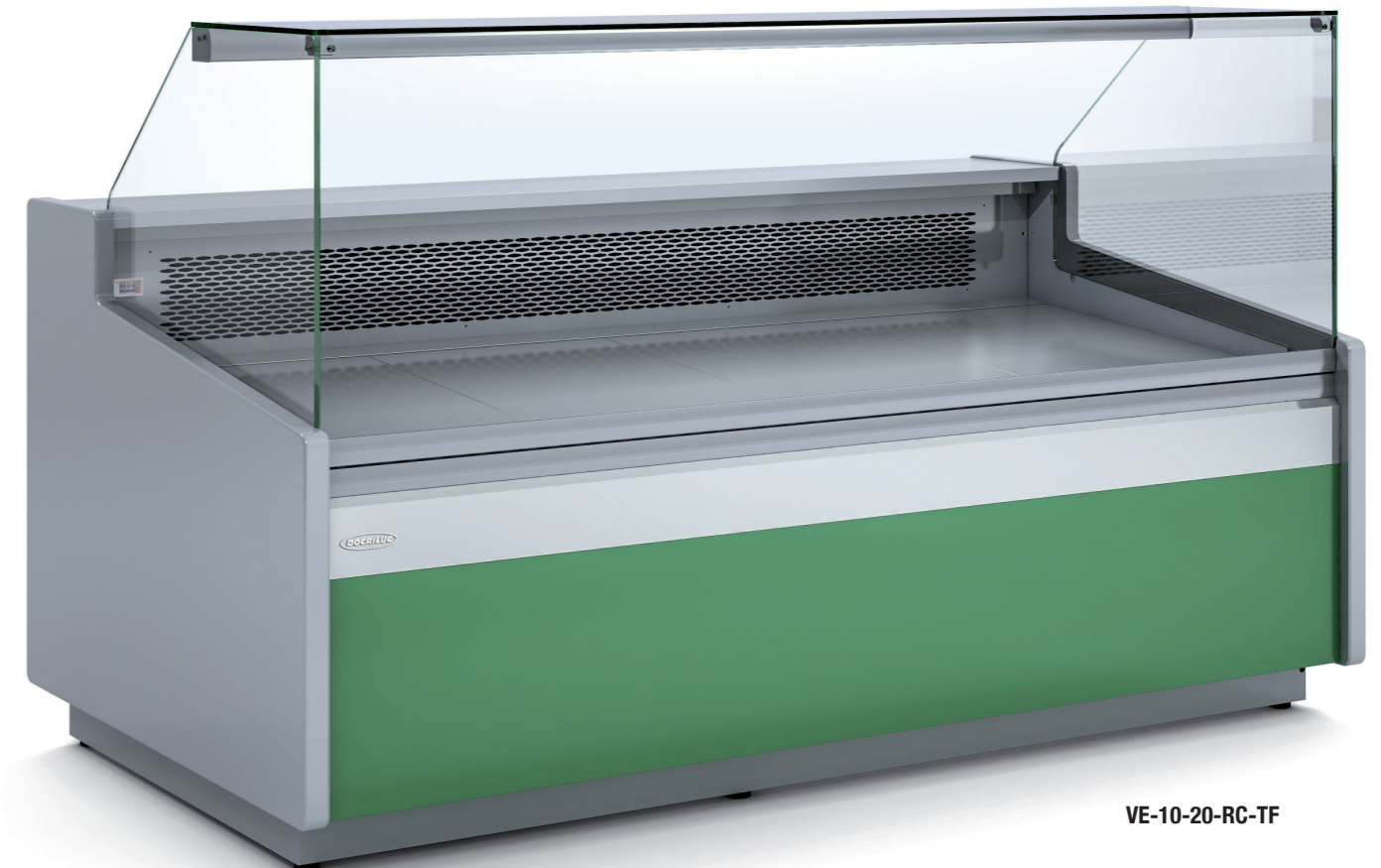

VE-10-20-RC-TF

VE-10-10-RCB-TF	2.382 €	VE-10-13-RCB-TF	2.739 €	VE-10-15-RCB-TF	2.918 €	VE-10-20-RCB-TF	3.473 €	VE-10-25-RCB-TF	4.058 €	VE-10-30-RCB-TF	4.776 €
VE-10-10-RC-TF	2.409 €	VE-10-13-RC-TF	2.804 €	VE-10-15-RC-TF	2.983 €	VE-10-20-RC-TF	3.532 €	VE-10-25-RC-TF	4.091 €	VE-10-30-RC-TF	4.794 €
VE-10-10-RC-R-TF	2.316 €	VE-10-13-RC-R-TF	2.639 €	VE-10-15-RC-R-TF	2.860 €	VE-10-20-RC-R-TF	3.291 €	VE-10-25-RC-R-TF	3.809 €	VE-10-30-RC-R-TF	4.579 €
VE-10-10-RC-C-TF	2.409 €	VE-10-13-RC-C-TF	2.804 €	VE-10-15-RC-C-TF	2.983 €	VE-10-20-RC-C-TF	3.532 €	VE-10-25-RC-C-TF	4.091 €	VE-10-30-RC-C-TF	4.794 €
VE-10-10-RC-CC-TF	2.501 €	VE-10-13-RC-CC-TF	2.757 €	VE-10-15-RC-CC-TF	3.116 €	VE-10-20-RC-CC-TF	3.563 €	VE-10-25-RC-CC-TF	4.117 €	VE-10-30-RC-CC-TF	4.989 €
VE-10-10-RC-MC-TF	2.316 €	VE-10-13-RC-MC-TF	2.639 €	VE-10-15-RC-MC-TF	2.860 €	VE-10-20-RC-MC-TF	3.291 €	VE-10-25-RC-MC-TF	3.809 €	VE-10-30-RC-MC-TF	4.579 €

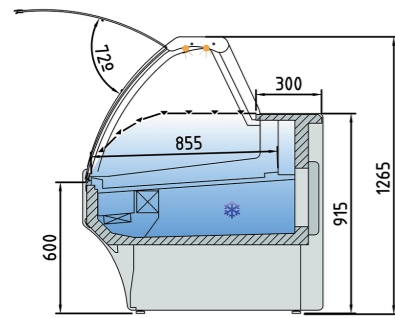

VE-10E-TF

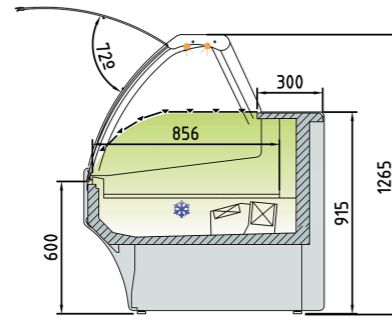

VES-10E-TF



detalle cristal elevable  
 detail lifting glass  
 detail vitre rabattable



6500K



RED FRESH

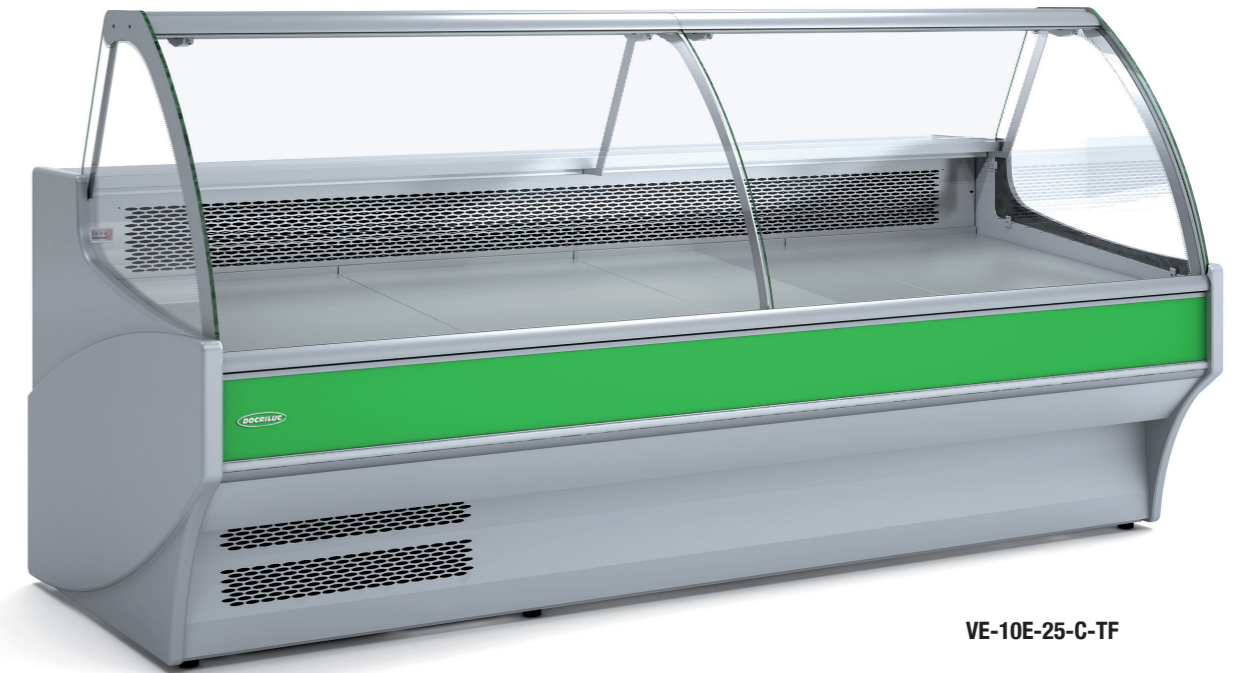

VE-10E-25-C-TF

**CARACTERÍSTICAS TÉCNICAS**

- Cristal frontal templado y elevable.
- Estante de cristal intermedio, opcional
- Iluminación estándar: encimera superior led
- Reserva refrigerada con puertas, hueco 440x270 (excepto modelo neutro)
- Evaporador ventilado.
- Condensación ventilada, evaporación automática de serie
- Evaporación estática opcional

**TECHNICAL DATA**

- Toughened curved and liftable glass.
- Glass shelf non refrigerated, optional
- Refrigerated under storage with doors, 440x270free (except for ambient models)
- Ventilated evaporator
- Ventilated condensation and automatic defrost evaporation as standard
- Optional static evaporation

**CARACTÉRISTIQUES TECHNIQUES**

- Vitre bombée sécurit rabattable levée
- Etagère en verre non réfrigérée
- Lumière standard en partie haute led
- Stockage réfrigéré, espace 440x270 (sauf modèles neutres)
- Evaporateur statique
- Condensation ventilé, évaporation automatique en standard
- Évaporation statique en option

Ver características técnicas en página 60 / See technical data in page 60 / Voir caractéristiques techniques page 60

Modelo Model Modèle	Largo Length Longueur (mm)	Cámara Storage Stockage (m <sup>3</sup> )	Exposición Display Exposition (m <sup>2</sup> )	Puertas Doors Portes (Uds)	Potencia frig. Frig. Power Puissance frig. (W)	Consumo Consumption Consommation (W)	Refrigerante Coolant Réfrigérant
VE / VES-10E-10-TF	1055	0,38	0,79	1	522	419	R-452A
VE / VES-10E-13-TF	1305	0,5	0,99	2	635	1037	R-452A
VE / VES-10E-15-TF	1525	0,58	1,17	2	817	1107	R-452A
VE / VES-10E-20-TF	2025	0,79	1,58	3	1096	1377	R-452A
VE / VES-10E-25-TF	2525	0,99	1,99	4	1315	1433	R-452A
VE / VES-10E-30-TF	2995	1,25	2,37	4	1315	1472	R-452A

230v 60Hz / 115v 60Hz. consultar - consult - consulter  
 Modelo estático / Static model / Statique modelé consultar - consult - consulter

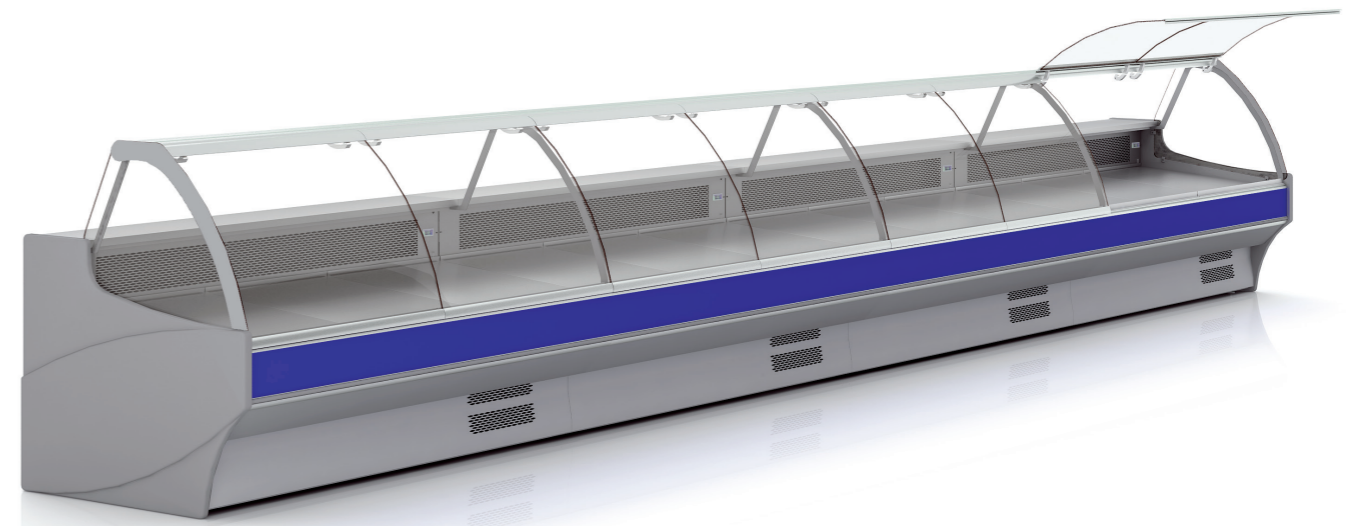

**OPCIONES · OPTIONS · OPTIONS**

Modelo Model Modèle	1 decoración frontal / front decor / décoration frontal	2 Total decoración / Total decor / décoration total	Puertas Cierre Plexi Plexi slide Doors Kit vitrage arrière coulissant plexi	Iluminación led blanco White led lighting Éclairage Led blanc	Iluminación led rosa Pink led lighting Éclairage Led rose	Cierre cortina Night blind Rideau nocturne	Estante cristal Glass shelf Plateau en verre	Neutra Neutral Neutre	Pre Instalación Remote Unit Groupe à distance
VE / VES-10E-10-TF	55 €	270 €	92 €	41 €	41 €	82 €	51 €	-410 €	-123 €
VE / VES-10E-13-TF	60 €	275 €	123 €	53 €	53 €	108 €	61 €	-461 €	-138 €
VE / VES-10E-15-TF	65 €	280 €	138 €	61 €	61 €	123 €	71 €	-513 €	-148 €
VE / VES-10E-20-TF	70 €	285 €	184 €	82 €	82 €	164 €	102 €	-615 €	-179 €
VE / VES-10E-25-TF	75 €	290 €	230 €	102 €	102 €	205 €	123 €	-872 €	-205 €
VE / VES-10E-30-TF	80 €	295 €	277 €	123 €	123 €	246 €	143 €	-995 €	-256 €

Características técnicas y constructivas sujetas a variación sin previo aviso / We reserve the right to change specifications without prior notice / Sujet technique et la conception de modifications sans préavis

VE-10E-10-C-TF <b>2.858 €</b>	VE-10E-13-C-TF <b>3.186 €</b>	VE-10E-15-C-TF <b>3.471 €</b>	VE-10E-20-C-TF <b>4.269 €</b>	VE-10E-25-C-TF <b>4.845 €</b>	VE-10E-30-C-TF <b>6.118 €</b>
VES-10E-10-C-TF <b>2.794 €</b>	VES-10E-13-C-TF <b>3.106 €</b>	VES-10E-15-C-TF <b>3.397 €</b>	VES-10E-20-C-TF <b>4.153 €</b>	VES-10E-25-C-TF <b>4.670 €</b>	VES-10E-30-C-TF <b>5.923 €</b>

**ÁNGULOS POSITIVOS / POSITIVE ANGLES / POSITIF ANGLES**

VE-10E-RP90-C <b>5.653 €</b>	VE-10E-AP90-C <b>5.653 €</b>
VES-10E-RP90-C <b>5.653 €</b>	VES-10E-AP90-C <b>5.653 €</b>

Vitrinas a medida largo especial  
 Voucher long as special  
 Bon tant que particulier

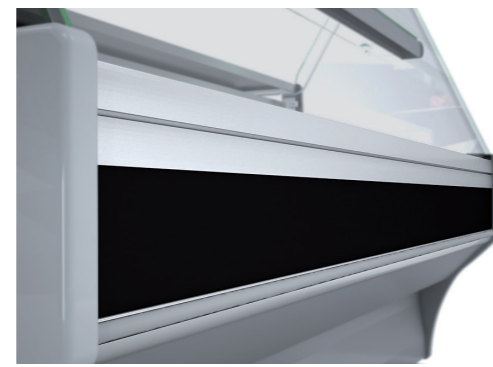
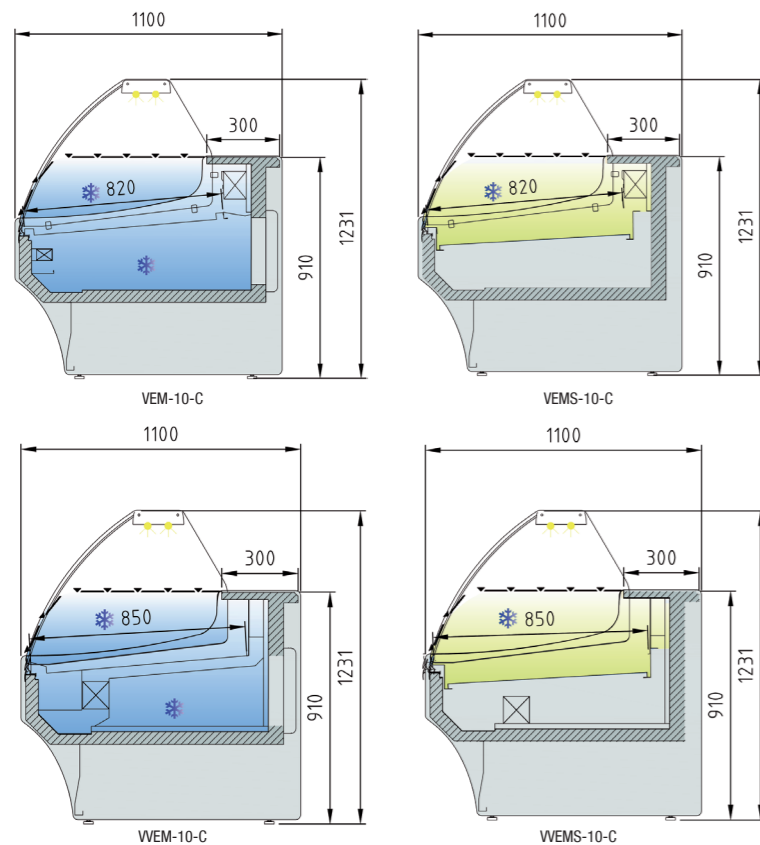

detalle perfilería anodizada  
 detail anodized profiles  
 profils anodisés détail

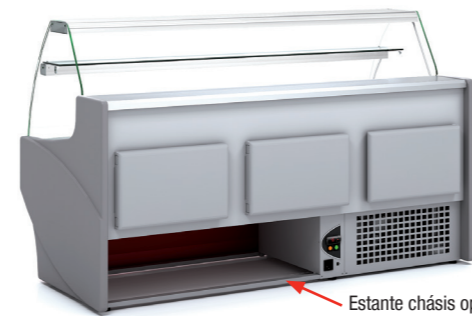

Estante chasis opcional  
 Chassis shelf optional  
 Etagère chasis en option  
 vista trasera / rear view / vue arrière



**CARACTERÍSTICAS TÉCNICAS**

**TECHNICAL DATA**

**CARACTÉRISTIQUES TECHNIQUES**

- Diseño especial para plazas y mercados
- **Precio por metro lineal de vitrina, costados no incluidos**
- Sin estante de cristal intermedio (mayor visibilidad)
- Iluminación estándar: encimera superior led
- Versión evaporador ventilado con una batería
- Versión evaporador estático con doble batería (una en la reserva)
- Condensación ventilada, evaporación automática de serie
- Descarche automático, opcional eléctrico
- Kit de unión incluido en el precio
- PR: Modelo pre-instalación
- **VEMS y VVEMS modelos sin reserva**, mismo precio que modelos VEM y VVEM
- JD10: Juego laterales

- Design focused for food market
- **Price per linear meter, sides not included**
- Without intermediate glass shelf (higher visibility)
- Ventilated version, one evaporator
- Static version with double evaporator (one in the under storage)
- Ventilated condensation and automatic defrost evaporation as standard
- Auto defrost, electric as optional
- Join kit included in price
- PR: remote condenser unit
- **VEMS and VVEMS models without reservation**, same price than VEM and VVEM models
- JD10: Sides kit

- Design special pour places et marchés
- **Prix par mètre linéaire de vitrine, côtés non inclus.**
- Aucune tablette intermédiaire en verre pour une meilleure visibilité
- Illumination standard: Plan de travail supérieur led
- Version évaporateur ventilé avec batterie
- Version évaporateur statique avec double batterie (une en réserve)
- Condensation ventilée, évaporation automatique de série
- Dégivrage automatique, sur option électrique
- Kit d'union inclus dans le prix
- PR: Modèle pré-installation
- **Modèles VEMS et VVEMS sans réserve**, même prix et VEM modèles VVEM
- JD10: Jeu côtés

Ver características técnicas en página 60 / See technical data in page 60 / Voir caractéristiques techniques page 60

Modelo Model Modèle	Largo Length Longueur (mm)	Cámara Storage Stockage (m <sup>3</sup> )	Exposición Display Exposition (m <sup>2</sup> )	Puertas Doors Portes (Uds)	Potencia frig. Frig. Power Puissance frig. (W)	Consumo Consumption Consommation (W)	refrigerante coolant Réfrigérant
VEM-VEM	1000	0,33	0,75	1	500W x m R-452A	715	R-452A

230v 60Hz / 115v 60Hz. consultar - consult - consulter



	Decoración inox Steel decoration Décoration inox	Kit cierre plexi Fkit doors plexi Kit vitrage arrière coulissant plexi	Total lacado Lacquered total Total laqué
incremento x m. increase x m. supplements x m.	51 € x m.	92 € x m.	266 € m

**PRECIO METRO LINEAL MÁS LATERALES - METRO PRICE MORE LINEAR SIDE - CÔTÉ DES PRIX METRO PLUS LINÉAIRE**

VENTILADA VENTILATED VENTILÉE	VENTILADA PREINSTALACIÓN VENTILATED REMOTE VENTILÉE FROID DISTANCE	ESTÁTICA STATIC STATIQUE	ESTÁTICA PREINSTALACIÓN STATIC REMOTE STATIQUE FROID DISTANCE
VEM-C 2.982 € VEMS-C 2.982 € JD10 300 €	VVEM-C-PR 2.613 € VVEMS-C-PR 2.613 € JD10 300 €	VEM-C 2.825 € VEMS-C 2.825 € JD10 300 €	VEM-C-PR 2.456 € VEMS-C-PR 2.456 € JD10 300 €

## Armarios expositores

Armarios expositores de carne y pescados



EXPOCARN-275

### Armarios expositores de carne

- Armario expositor de carne que incluye estantes y ganchos para la exposición de carne.
- La versión DA, permite el envejecimiento de la carne. Es una vitrina equipada con un sistema para la producción y gestión de la humedad desde el 50% al 80%. Este sistema permite un control continuo de la pérdida del peso de la carne.
- Panel de control electrónico con USB.
- Se presentan dos versiones de 550 litros y 1150 litros.
- Marco en aluminio, color plata.
- Rejillas de ventilación de acero inoxidable.
- Triple cristal, para un máximo rendimiento de equipo y asegurar la conservación del producto con el mejor rendimiento energético.
- Estantes de acero inoxidable, regulables en altura, dimensiones 555 x 650mm + ganchos
- Para facilitar su desplazamiento se suministran con 4 ruedas giratorias, 2 de ellas con freno.
- Iluminación interior en LED.



La versión DA, permite la maduración de la carne.

Modelo	Referencia	Capacidad (l)	Potencia (W)	Temperatura trabajo (°C)	Evaporación	Desescarche	Nº de estantes	Medidas totales (mm)	P.V.P. Euros €
EXPOCARN-275	19067388	275	450	+1°C a +6°C	Estática	Automático	1	795 x 730 x 1240	5.500,00
EXPOCARN-551	19067390	550	700	+1°C a +6°C	Estática	Automático	3	795 x 730 x 2005	5.959,00
EXPOCARN-1151	19067391	1150	950	+1°C a +6°C	Estática	Automático	6	1542 x 730 x 2005	8.929,00
EXPOCARN-275-DA	19067392	275	750	+1°C a +2°C	Ventilada	Automático	3	795 x 730 x 1240	7.601,00
EXPOCARN-1151-DA	19067393	1151	950	+1°C a +2°C	Ventilada	Automático	6	1542 x 730 x 2005	9.938,00



EXPOGN-650

### Armarios expositores de pescados

- Armario expositor de pescados que permite una amplia exposición y conservación del producto.
- Panel de control electrónico con USB.
- Se presentan la versión de 650 litros.
- Evaporador estático.
- Marco en aluminio, color plata.
- Rejillas de ventilación de acero inoxidable.
- Triple cristal, para un máximo rendimiento de equipo y asegurar la conservación del producto con el mejor rendimiento energético.
- Para facilitar su desplazamiento se suministran con 4 ruedas giratorias, 2 de ellas con freno.
- Iluminación interior en LED.



Evaporador estático para una perfecta conservación del producto.

Modelo	Referencia	Capacidad (l)	Potencia (W)	Temperatura trabajo (°C)	Evaporación	Desescarche	Medidas totales (mm)	P.V.P. Euros €
EXPOGN-650	19067394	650	650	-2°C a +0°C	Estática	Automático	855 x 730 x 1810	4.891,00



## Expositores refrigerados de ingredientes para ensaladas y pizzas

### Expositores refrigerados de ingredientes para ensaladas y pizzas



EIV-180



EIT-180



EIT-180

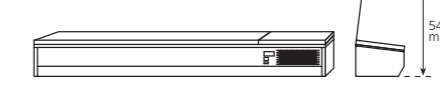

EIV-180

- Construcción exterior e interior en acero inoxidable AISI-304 18/10.
- Modelos EIV: protección con vitrina de cristal.
- Modelos EIT: con tapa de acero inoxidable 18/10.
- Capacidad para cubetas GN 1/4 de profundidad 150 mm (no incluidas en dotación).
- Interior con uniones curvas para facilitar la limpieza.
- Grupo frigorífico incorporado.
- Aislamiento de poliuretano inyectado, libre de CFC, con una densidad de 40 Kg/m<sup>3</sup>.
- Interruptor luminoso de marcha-paro.
- Refrigeración por placa fría.
- Control electrónico de la temperatura con visor digital. Desescarche automático.
- Temperatura de trabajo de +4° a +8° C.
- Tensión de trabajo: 230 V 1+N - 50 Hz.



Interruptor luminoso de marcha-paro.



Control electrónico de la temperatura.

Modelo	Referencia	Alojamiento GN 1/4	Compresor (CV)	Dimensiones (mm)	P.V.P. Euros €
EIV-135 HC	19060595	5	0,12	1350 x 350 x 450	1.205,00
EIV-180 HC	19060593	8	0,12	1750 x 350 x 450	1.288,00
EIV-225 HC	19060610	10	0,12	2300 x 350 x 450	1.426,00
EIT-135 HC	19060598	5	0,12	1350 x 336 x 222	1.049,00
EIT-180 HC	19060597	8	0,12	1800 x 336 x 222	1.141,00

### Expositores refrigerados de alimentos (bandejas frías)

- Construcción interior de acero inoxidable AISI-304 18/10.
- Puertas correderas de cristal.
- Vitrina de cristal curvo.
- Grupo frigorífico incorporado.
- Iluminación LED para máxima iluminación y mínimo consumo.
- Interruptor luminoso de marcha-paro.
- Iluminación interior con protección.
- Refrigeración por placa fría.
- Refrigerante ecológico R-134 A libre de CFC.
- Provistos de desagüe.
- Temperatura de trabajo de +4° a +8° C con 38° C de temperatura ambiente.
- Tensión de trabajo: 230 V 1+N - 50 Hz.
- Control electrónico de la temperatura con visor digital.
- Vitrinas Tapas:
  - Cubetas Gastronorm GN 1/3 de profundidad 40 mm incluidas en dotación.
  - 2 modelos con capacidad para 6 y 8 cubetas.
  - Interior con uniones curvas para facilitar la limpieza.
- Vitrinas Sushi:
  - Incorpora doble evaporador de alto rendimiento diseñado para las más exigentes condiciones de mantenimiento de temperatura.
  - Bandeja interior embutida, perforada para recibir directamente los platos sushi.



EXA-6



EXA-8



EXA-6 SUSHI  
EXA-8 SUSHI



EXA-6



EXA-6 SUSHI

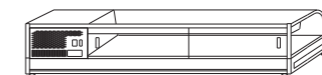

EXA-8  
EXA-8 SUSHI

Modelo	Referencia	Alojamiento GN 1/4	Potencia (W)	Familia	Dimensiones (mm)	P.V.P. Euros €
EXA-6 HC	19060222	6	0,11	Tapas	1395 x 400 x 250	1.089,00
EXA-8 HC	19060221	8	0,11	Tapas	1740 x 400 x 250	1.223,00
EXAS-6 HC	19060224	6	0,11	Sushi	1395 x 400 x 250	1.359,00
EXAS-8 HC	19060225	8	0,11	Sushi	1740 x 400 x 250	1.464,00

# MEAT

★ PRODUCTO PREMIUM



Meat 1150 M

## CARACTERÍSTICAS PRINCIPALES

- Armarios expositores de cuatro caras de cristal de 550 y 1150 litros especialmente diseñados para la conservación de la carne.
- Estructura exterior en aluminio anodizado con triple cristal y rejillas de ventilación de acero inoxidable. Sistema de refrigeración con evaporador estático por gravedad para una perfecta conservación del producto.
- Iluminación interior con luz LED para realzar la visibilidad del productos expuesto a lo largo de toda la vitrina.
- Triple cristal para un aislamiento perfecto y un consumo energético óptimo.
- Incluye cuadro de control electrónico, 3 estantes, 5 ganchos y 2 barras por puerta.
- Estantes ajustables.



Rejillas de acero inoxidable regulables en altura.



Barra de carnicería con ganchos móviles para colgar piezas de carne.



Cuadro de mandos con termostato y termómetro.



Iluminación interior mediante LEDs.

**Servicios opcionales\***

**Aplicación**

**Características**

## CARACTERÍSTICAS TÉCNICAS

MODELO		Meat 550 M	Meat 1150 M
Código		OITF0013	OITF0586
Capacidad neta	L	550	1150
Rango de temperatura	°C	+1 / +6	+1 / +6
Alimentación eléctrica	V / Ph / Hz	230 / 1 / 50	230 / 1 / 50
Potencia eléctrica	W	700	950
Clase climática	Tipo	4	4
Condensación	Tipo	Ventilada	Ventilada
Desescarche	Tipo	Automático	Automático
Evaporador	Tipo	Estático	Estático
Refrigerante	Tipo	R-134a	R-134a
Ancho / fondo / alto	mm	796 / 730 / 2005	1542 / 730 / 2005
Peso bruto / neto	kg	230 / 204	350 / 319
<b>PVP</b>		<b>5309 €</b>	<b>7963 €</b>

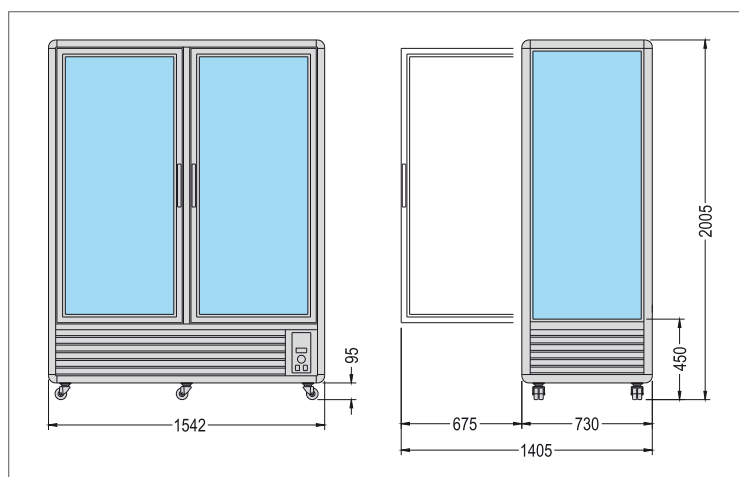

Meat 550 M

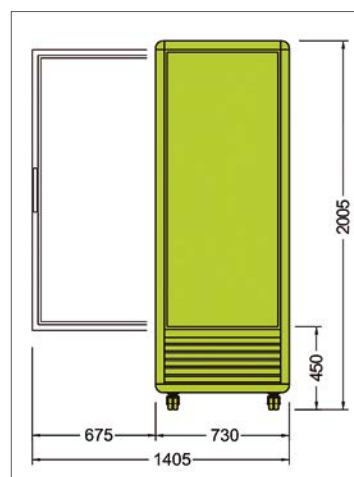

Meat 1150 M

ACCESORIOS	Estante adicional (550x650 mm.)
Código	OITF9165K
PVP	80 €

\*Para contratar Servicios opcionales ver final del catálogo.  
Reservados los derechos a modificar modelos y datos técnicos.

# VITRINA EXPOSITORA DISPLAY CASE

Fotos no contractuales / Non contractual pictures











**Estante opcional**  
Optional shelf

VAL 12

**La vitrina se suministra con los cristales y decoración desmontada**

Display case provides with glasses and disassembled decoration

MOD.	 Potencia Power (W)	 Tensión/Frecuencia Electrical (V/Hz)	 Capacidad Capacity (L)	 Puertas Doors	 Superficie exposición (m <sup>2</sup> )	 Compresor Compressor (HP)	 Consumo Consumption (kWh/24h)	 Evaporación Evaporation	 Potencia frigorífica Cooling capacity (W a -10°C)	 Desescarche Defrost	 Control	 Refrigerante Coolant
VAL9	382	230/50	154	1	0,4	1/4	6,1	Semi Estática Semi Static	353	Manual	Digital	R134a
VAL12	442	230/50	205	1	0,6	1/3	7,1	Semi Estática Semi Static	414	Manual	Digital	R134a
VAL15	445	230/50	256	2	0,7	3/8	7,1	Semi Estática Semi Static	464	Manual	Digital	R134a
VAL18	547	230/50	308	3	0,9	1/2	8,8	Semi Estática Semi Static	568	Manual	Digital	R134a
VAL25	654	230/50	410	4	1,2	5/8	10,5	Semi Estática Semi Static	684	Manual	Digital	R134a
VAL28	729	230/50	461	4	1,3	3/4	11,7	Semi Estática Semi Static	792	Manual	Digital	R134a



# VITRINAS EXPOSITORAS DISPLAY CASES

## SERIE ALMERIA SERIES



VAL 18

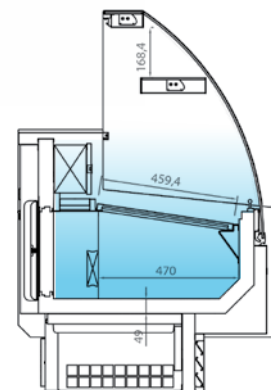

VAL 15

Opciones y decoraciones pag. 305  
Options & decorations pag. 305

### VAL9

1.505 €

998x843x1280 mm

Temp. 2°C/+6°C  
C. Clima. 4

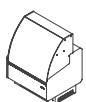

### VAL12

1.636 €

1310x843x1280 mm

Temp. 2°C/+6°C  
C. Clima. 4

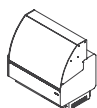

### VAL15

1.783 €

1622x843x1280 mm

Temp. 2°C/+6°C  
C. Clima. 4

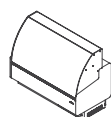

### VAL18

2.115 €

1935x843x1280 mm

Temp. 2°C/+6°C  
C. Clima. 4

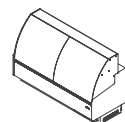

### VAL25

2.457 €

2560x843x1280 mm

Temp. 2°C/+6°C  
C. Clima. 4

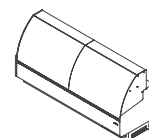

### VAL28

2.811 €

2872x843x1280 mm

Temp. 2°C/+6°C  
C. Clima. 4

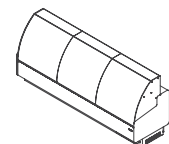

8.













# VITRINA EXPOSITORA

## DISPLAY CASE



VAL 12P

MOD.

	 Potencia Power (W)	 Tensión/Frecuencia Electrical (V/Hz)	 Capacidad Capacity (L)	 Puertas Doors	 Superficie exposición (m <sup>2</sup> )	 Compresor Compressor (HP)	 Consumo Consumption (kWh/24h)	 Evaporación Evaporation	 Potencia frigorífica Cooling capacity (W a -10°C)	 Desescarche Defrost	 Control	 Refrigerante Coolant
VAL9P	382	230/50	154	1	0,4	1/4	6,1	Semi Estática Semi Static	353	Manual	Digital	R134a
VAL12P	442	230/50	205	1	0,6	1/3	7,1	Semi Estática Semi Static	414	Manual	Digital	R134a
VAL15P	445	230/50	256	2	0,7	3/8	7,1	Semi Estática Semi Static	464	Manual	Digital	R134a
VAL18P	547	230/50	308	3	0,9	1/2	8,8	Semi Estática Semi Static	568	Manual	Digital	R134a
VAL25P	654	230/50	410	4	1,2	5/8	10,5	Semi Estática Semi Static	684	Manual	Digital	R134a
VAL28P	729	230/50	461	4	1,3	3/4	11,7	Semi Estática Semi Static	792	Manual	Digital	R134a

# VITRINAS EXPOSITORAS DISPLAY CASES

## SERIE ALMERIA SERIES



VAL 18P

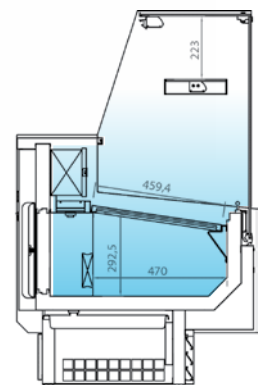

VAL15P

### VAL9P

1.535 €

998x843x1315 mm

Temp. 2°C/+6°C  
C. Clima. 4



### VAL12P

1.669 €

1310x843x1315 mm

Temp. 2°C/+6°C  
C. Clima. 4

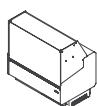

### VAL15P

1.818 €

1622x843x1315 mm

Temp. 2°C/+6°C  
C. Clima. 4

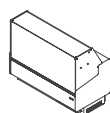

### VAL18P

2.157 €

1935x843x1315 mm

Temp. 2°C/+6°C  
C. Clima. 4

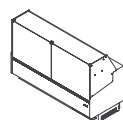

### VAL25P

2.506 €

2560x843x1315 mm

Temp. 2°C/+6°C  
C. Clima. 4

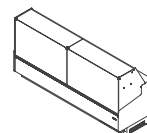

### VAL28P

2.867 €

2872x843x1315 mm

Temp. 2°C/+6°C  
C. Clima. 4

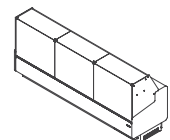

# VITRINA EXPOSITORA DISPLAY CASE

Fotos no contractuales / Non contractual pictures



**Estante opcional**  
Optional shelf

VGR 12

MOD.

Potencia Power (W)	Tensión/Frecuencia Electrical (V/Hz)	Capacidad Capacity (L)	Puertas Doors	Superficie exposición (m <sup>2</sup> )	Compresor Compressor (HP)	Consumo Consumption (kWh/24h)	Evaporación Evaporation	Potencia frigorífica Cooling capacity (W a -10°C)	Desescarche Defrost	Control	Refrigerante Coolant
--------------------------	--	------------------------------	------------------	---	---------------------------------	-------------------------------------	----------------------------	---	------------------------	---------	-------------------------

VGR9	382	230/50	189	1	0,6	1/4	6,1	Semi Estática Semi Static	353	Manual	Digital	R134a
VGR12	442	230/50	253	1	0,8	1/3	7,1	Semi Estática Semi Static	414	Manual	Digital	R134a
VGR15	445	230/50	316	2	1,0	3/8	7,1	Semi Estática Semi Static	464	Manual	Digital	R134a
VGR18	547	230/50	379	3	1,1	1/2	8,8	Semi Estática Semi Static	568	Manual	Digital	R134a
VGR25	654	230/50	505	4	1,5	5/8	10,5	Semi Estática Semi Static	684	Manual	Digital	R134a
VGR28	729	230/50	568	4	1,7	3/4	11,7	Semi Estática Semi Static	792	Manual	Digital	R134a

# VITRINAS EXPOSITORAS DISPLAY CASES

## SERIE GRANADA SERIES



VGR 18

La vitrina se suministra con los cristales y decoración desmontada

Display case provides with glasses and disassembled decoration

Opciones y decoraciones pag. 305

Options & decorations pag. 305

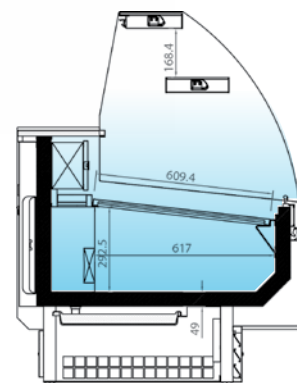

VGR

### VGR 9

1.652 €

998x993x1280 mm

Temp. 2°C/+6°C  
C. Clima. 4

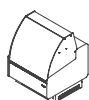

### VGR 12

1.828 €

1310x993x1280 mm

Temp. 2°C/+6°C  
C. Clima. 4

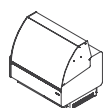

### VGR 15

1.943 €

1622x993x1280 mm

Temp. 2°C/+6°C  
C. Clima. 4

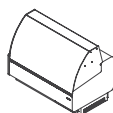

### VGR 18

2.239 €

1935x993x1280 mm

Temp. 2°C/+6°C  
C. Clima. 4

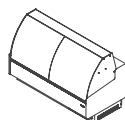

### VGR 25

2.673 €

2560x993x1280 mm

Temp. 2°C/+6°C  
C. Clima. 4

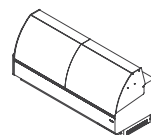

### VGR 28

3.084 €

2872x993x1280 mm

Temp. 2°C/+6°C  
C. Clima. 4

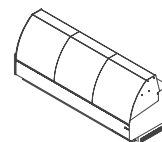

8.













# VITRINA EXPOSITORA

## DISPLAY CASE



VGR 12P

MOD.

	 Potencia Power (W)	 Tensión/Frecuencia Electrical (V/Hz)	 Capacidad Capacity (L)	 Puertas Doors	 Superficie exposición (m²)	 Compresor Compressor (HP)	 Consumo Consumption (kWh/24h)	 Evaporación Evaporation	 Potencia frigorífica Cooling capacity (W a -10°C)	 Desescarche Defrost	 Control	 Refrigerante Coolant
VGR9 P	382	230/50	189	1	0,6	1/4	6,1	Semi Estática Semi Static	353	Manual	Digital	R134a
VGR12 P	442	230/50	253	1	0,8	1/3	7,1	Semi Estática Semi Static	414	Manual	Digital	R134a
VGR15 P	445	230/50	316	2	1,0	3/8	7,1	Semi Estática Semi Static	464	Manual	Digital	R134a
VGR18 P	547	230/50	379	3	1,1	1/2	8,8	Semi Estática Semi Static	568	Manual	Digital	R134a
VGR25 P	654	230/50	505	4	1,5	5/8	10,5	Semi Estática Semi Static	684	Manual	Digital	R134a
VGR28 P	729	230/50	568	4	1,7	3/4	11,7	Semi Estática Semi Static	792	Manual	Digital	R134a

# VITRINAS EXPOSITORAS DISPLAY CASES

## SERIE GRANADA SERIES



VGR 18P

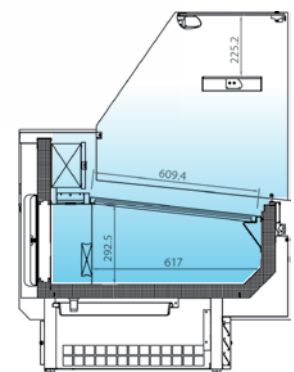

VGR 18P

**La vitrina se suministra con los cristales y decoración desmontada**  
 Display case provides with glasses and disassembled decoration

### VGR 9P

**1.685 €**

998x993x1280 mm

Temp. 2°C/+6°C  
 C. Clima. 4



### VGR 12P

**1.865 €**

1310x993x1280 mm

Temp. 2°C/+6°C  
 C. Clima. 4

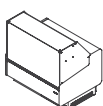

### VGR 15P

**1.981 €**

1622x993x1280 mm

Temp. 2°C/+6°C  
 C. Clima. 4

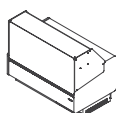

### VGR 18P

**2.283 €**

1935x993x1280 mm

Temp. 2°C/+6°C  
 C. Clima. 4

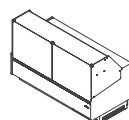

### VGR 25P

**2.727 €**

2560x993x1280 mm

Temp. 2°C/+6°C  
 C. Clima. 4

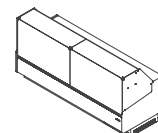

### VGR 28P

**3.145 €**

2872x993x1280 mm

Temp. 2°C/+6°C  
 C. Clima. 4

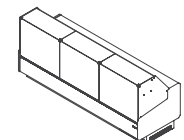

8.

# VITRINA EXPOSITORA

## DISPLAY CASE

### CARACTERÍSTICAS SPECIFICATIONS

Fotos no contractuales / Non contractual pictures

- Chapa de acero plastificada
- Cristal curvo o plano securizado
- Bancada en acero esmaltado
- Claro de puerta de acceso media reserva 445x265
- Plano de exposición en acero esmaltado
- Iluminación en perfil superior
- Ventiladores en reserva

- Laminated steel plate
- Curved tempered security glass system
- Enamelled steel base
- Storage door opening 445x265
- Enamelled exhibition steel surface
- Upper profile lighting
- Storage fans

### OPCIONES OPTIONS

## SERIE ALMERÍA SERIES

MOD.	Puertas correderas traseras Rear sliding doors	Estante iluminado Lighting shelf
VAL9	[PUEVLMR10CT] 98 €	[ESTLMRGRD10] 105 €
VAL12	[PUEVLMR12CT] 121 €	[ESTLMRGRD12] 130 €
VAL15	[PUEVLMR15CT] 145 €	[ESTLMRGRD15] 156 €
VAL18	[PUEVLMR20CT] 196 €	[ESTLMRGRD20] 203 €
VAL25	[PUEVLMR25CT] 244 €	[ESTLMRGRD25] 253 €
VAL28	[PUEVLMR30CT] 297 €	[ESTLMRGRD30] 292 €

## SERIE GRANADA SERIES

MOD.	Puertas correderas traseras Rear sliding doors	Estante iluminado Lighting shelf
VGR9	[PUEVGRD10CT] 98 €	[ESTLMRGRD10] 105 €
VGR12	[PUEVGRD12CT] 121 €	[ESTLMRGRD12] 130 €
VGR15	[PUEVGRD15CT] 145 €	[ESTLMRGRD15] 156 €
VGR18	[PUEVGRD18CT] 196 €	[ESTLMRGRD18] 203 €
VGR25	[PUEVGRD25CT] 244 €	[ESTLMRGRD25] 253 €
VGR28	[PUEVGRD28CT] 297 €	[ESTLMRGRD28] 292 €



# SERIE ALMERIA & GRANADA SERIES



 RAL 9017  
Negro  
Black

 RAL 3003  
Granate  
Maroon

 RAL 6002  
Verde oscuro  
Green dark

 RAL 6019  
Verde claro  
Green clear



 RAL 9016  
Blanco  
White

 RAL 2003  
Naranja  
Orange

 RAL 5015  
Azul  
Blue

 RAL 1018  
Amarillo  
Yellow



 RAL 3020  
Rojo  
Red



**Otro color consultar precio**  
Other colour consult price

# VITRINA EXPOSITORA FRIO VENTILADO

## REFRIGERATED WITH STORAGE DISPLAY CASE

Fotos no contractuales / Non contractual pictures



VMB 15 R

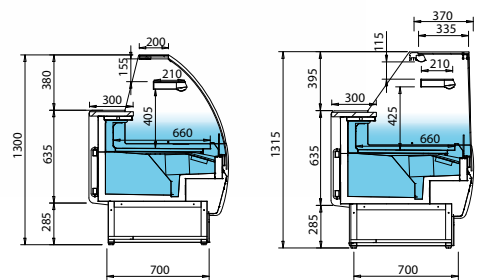

VMB R

VMB RP

### Opciones y decoraciones pag. 313

Options &amp; decorations pag. 313

MOD.	Potencia Power (W)	Tensión/Frecuencia Electrical (V/Hz)	Capacidad Capacity (L)	Puertas Doors	Superficie exposición (m <sup>2</sup> )	Estantes Shelving	Compresor Compressor (HP)	LED	Consumo Consumption (kWh/24h)	Evaporación Evaporation	Potencia frigorífica Cooling capacity (W a -10°C)	Desescarche Defrost	Control	Refrigerante Coolant
VMB 9 R VMB 9 RP	700	230/50	103	1	0,62	1	1/2	✓	9,8	Forzada Forced	817	Automático Automatic	Digital	R-452
VMB 12 R VMB 12 RP	950	230/50	138	2	0,83	1	5/8	✓	13,3	Forzada Forced	1096	Automático Automatic	Digital	R-452
VMB 15 R VMB 15 RP	1000	230/50	172	2	1,03	1	3/4	✓	14,0	Forzada Forced	1315	Automático Automatic	Digital	R-452
VMB 18 R VMB 18 RP	1230	230/50	206	3	1,24	1	1	✓	17,2	Forzada Forced	1506	Automático Automatic	Digital	R-452
VMB 25 R VMB 25 RP	1460	230/50	275	4	1,65	1	1+1/6	✓	20,4	Forzada Forced	2009	Automático Automatic	Digital	R-452

# VITRINAS EXPOSITORAS DISPLAY CASES

## SERIE MARBELLA SERIES



VMB 25 RP

### VMB 9 R

2.064 €

998x953x1300/1315 mm

Temp. 0°C/+6°C  
C. Clima. 4



### VMB 12 R

2.344 €

1310x953x1300/1315 mm

Temp. 0°C/+6°C  
C. Clima. 4



### VMB 15 R

2.587 €

1622x953x1300/1315 mm

Temp. 0°C/+6°C  
C. Clima. 4



### VMB 18 R

3.009 €

1935x953x1300/1315 mm

Temp. 0°C/+6°C  
C. Clima. 4



### VMB 25 R

3.524 €

2560x953x1300/1315 mm

Temp. 0°C/+6°C  
C. Clima. 4

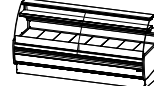

### VMB 9 RP

2.088 €

998x953x1300/1315 mm

Temp. 0°C/+6°C  
C. Clima. 4



### VMB 12 RP

2.366 €

1310x953x1300/1315 mm

Temp. 0°C/+6°C  
C. Clima. 4



### VMB 15 RP

2.619 €

1622x953x1300/1315 mm

Temp. 0°C/+6°C  
C. Clima. 4



### VMB 18 RP

3.007 €

1935x953x1300/1315 mm

Temp. 0°C/+6°C  
C. Clima. 4

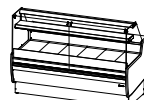

### VMB 25 RP

3.522 €

2560x953x1300/1315 mm

Temp. 0°C/+6°C  
C. Clima. 4



8.

# VITRINA EXPOSITORA FRÍO VENTILADO CON RESERVA

## REFRIGERATED WITH STORAGE DISPLAY CASE















Fotos no contractuales / Non contractual pictures



VMC 12 R



MOD.

	 Potencia Power [W]	 Tensión Frecuencia Electrical [V/Hz]	 Capacidad Capacity [L]	 Puertas Doors	 Superficie exposición [m²]	 Estantes Shelving	 Compresor Compressor [HP]	 LED	 Consumo Consumption [kWh/24h]	 Evaporación Evaporation	 Potencia frigorífica Cooling capacity [W a -10°C]	 Desescarche Defrost	 Control	 Refrigerante Coolant
VMC 9 R	730	230/50	131	1	0,76	1	1/2	✓	10,2	Forzada Forced	817	Automático Automatic	Digital	R-452
VMC 12 R	980	230/50	175	2	1,01	1	5/8	✓	13,7	Forzada Forced	1096	Automático Automatic	Digital	R-452
VMC 15 R	1030	230/50	219	2	1,27	1	3/4	✓	14,4	Forzada Forced	1315	Automático Automatic	Digital	R-452
VMC 18 R	1260	230/50	263	3	1,52	1	1	✓	17,6	Forzada Forced	1506	Automático Automatic	Digital	R-452
VMC 25 R	1520	230/50	350	4	2,03	1	1+1/6	✓	21,3	Forzada Forced	2009	Automático Automatic	Digital	R-452

# VITRINAS EXPOSITORAS DISPLAY CASES

## SERIE MALLORCA SERIES



VMC 18 R

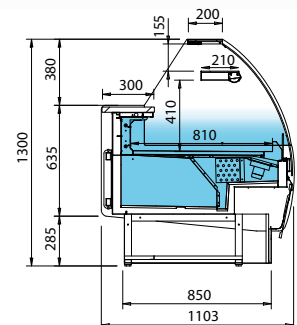

### VMC 9 R

2.223 €

998x1103x1300 mm

Temp. 0°C/+6°C  
C. Clima. 4



### VMC 12 R

2.473 €

1310x1103x1300 mm

Temp. 0°C/+6°C  
C. Clima. 4



### VMC 15 R

2.810 €

1622x1103x1300 mm

Temp. 0°C/+6°C  
C. Clima. 4



### VMC 18 R

3.128 €

1935x1103x1300 mm

Temp. 0°C/+6°C  
C. Clima. 4

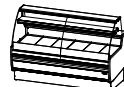

### VMC 25 R

3.632 €

2560x1103x1300 mm

Temp. 0°C/+6°C  
C. Clima. 4

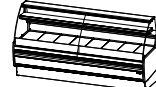

8.

# MUEBLE CAJA MOSTRADOR COUNTER CASE

Fotos no contractuales / Non contractual pictures



VMC 15 M



VMC 12 M

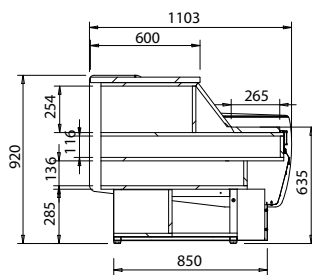

VMC 9 C

1.124 €

998x1103x920 mm



VMC 12M

1.162 €

1310x1103x920 mm



VMC 15 M

1.278 €

1622x1103x920 mm



MOD.



Potencia  
Power  
[W]



Tensión/Frecuencia  
Electrical  
[V/Hz]



Superficie exposición  
[m<sup>2</sup>]

MOD.	Potencia Power [W]	Tensión/Frecuencia Electrical [V/Hz]	Superficie exposición [m <sup>2</sup> ]
VMC 9 C	5	230/50	0,55
VMC 12 M	6	230/50	0,74
VMC 15 M	7	230/50	0,94

# SERIE MALLORCA & MARBELLA SERIES



VMB 12 M

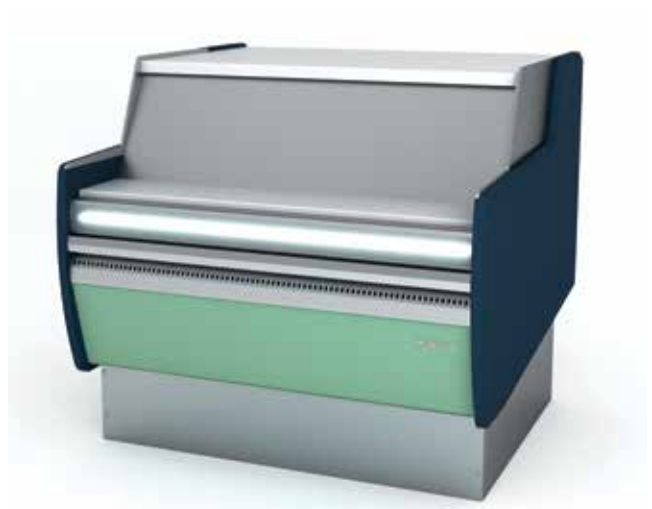

VMB 9 C

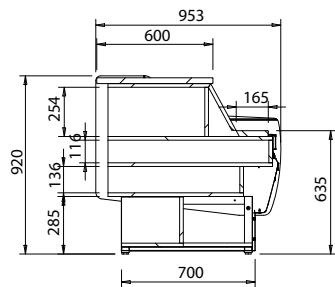

Opciones y decoraciones pag. 313  
Options & decorations pag. 313

**VMB 9 C**

**1.078 €**

998x953x1300/1315 mm



**VMB 12 M**

**1.114 €**

1310x953x1300/1315 mm

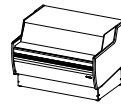



**VMB 15 M**

**1.249 €**

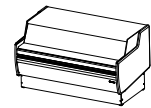
1622x953x1300/1315 mm



MOD.	 Potencia Power [W]	 Tensión/Frecuencia Electrical [V/Hz]	 Nº cajones Drawers
VMB 9 C	700	230/50	0,62
VMB 12 M	950	230/50	0,83
VMB 15 M	1000	230/50	1,03

# OPCIONES Y DECORACIÓN

## OPTIONS AND DECORATION

### SERIE MARBELLA SERIES

#### OPCIONES OPTIONS

MOD.	Puertas correderas traseras Rear sliding doors	Luz LED decoración frontal Frontal decoration LED lighting	Luz LED estante LED lighting shelf
VMB 9 R VMB 9 RP	[PUEVMB9CT] 98 € [PUEVMB9CTCP] 98 €	[ILUDECVMBC9] 48 €	[ILUESTVMBC9] 48 €
VMB 12 R VMB 12 RP	[PUEVMB12CT] 145 € [PUEVMB12CTCP] 145 €	[ILUDECVMBC12] 65 €	[ILUESTVMBC12] 65 €
VMB 15 R VMB 15 RP	[PUEVMB15CT] 196 € [PUEVMB15CTCP] 196 €	[ILUDECVMBC15] 80 €	[ILUESTVMBC15] 80 €
VMB 18 R VMB 18 RP	[PUEVMB18CT] 244 € [PUEVMB18CTCP] 244 €	[ILUDECVMBC18] 96 €	[ILUESTVMBC18] 96 €
VMB 25 R VMB 25 RP	[PUEVMB25CT] 297 € [PUEVMB25CTCP] 297 €	[ILUDECVMBC25] 128 €	[ILUESTVMBC25] 128 €

- Chapa de acero plastificada
- Cristal curvo securizado [R]
- Cristal recto securizado [RP]
- Bancada en acero esmaltado
- Claro de puerta de acceso media reserva 445x265
- Plano de exposición en acero esmaltado
- Iluminación LED plano de exposición
- Sistema de condensación ventilada
- Control temperatura final del desescarche
- Bandeja evaporativa automática

- Laminated steel plate
- Curved tempered security glass system [R]
- Flat tempered security glass system [RP]
- Enamelled steel base
- Storage door opening 445x265
- Enamelled exhibition steel surface
- Upper profile LED lighting for exhibition surface
- Forced air refrigeration system
- Control of the final defrost temperature
- Automatic evaporative tray

### SERIE MALLORCA SERIES

#### OPCIONES OPTIONS

MOD.	Puertas correderas traseras Rear sliding doors	Luz LED decoración frontal Frontal decoration LED lighting	Luz LED estante LED lighting shelf
VMC 9	[PUEVMC9CT] 98 €	[ILUDECVMBC9] 48 €	[ILUESTVMBC9] 48 €
VMC 12	[PUEVMC12CT] 145 €	[ILUDECVMBC12] 65 €	[ILUESTVMBC12] 65 €
VMC 15	[PUEVMC15CT] 196 €	[ILUDECVMBC15] 80 €	[ILUESTVMBC15] 80 €
VMC 18	[PUEVMC18CT] 244 €	[ILUDECVMBC18] 96 €	[ILUESTVMBC18] 96 €
VMC 25	[PUEVMC25CT] 297 €	[ILUDECVMBC25] 128 €	[ILUESTVMBC25] 128 €

- Chapa de acero plastificada
- Cristal curvo securizado
- Bancada en acero esmaltado
- Claro de puerta de acceso media reserva 425x255
- Plano de exposición en acero esmaltado
- Iluminación LED plano de exposición
- Bandeja evaporativa automática
- Sistema de condensación ventilada
- Control temperatura final del desescarche

- Laminated steel plate
- Curved tempered security glass system
- Enamelled steel base
- Storage door opening 425x255
- Enamelled exhibition steel surface
- Upper profile LED lighting for exhibition surface
- Automatic evaporative tray
- Forced air refrigeration system
- Control of the final defrost temperature













# SERIE MALLORCA & MARBELLA SERIES



**DECORACIÓN LACADA**  
LACQUED DECORATION

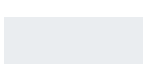

**Otro color consultar precio**  
Other colour consult price

-  RAL 3003  
Granate  
Maroon
-  RAL 2003  
Naranja  
Orange
-  RAL 5015  
Azul  
Blue
-  RAL DESIGN  
1107060  
Pistacho  
Pistachio
-  RAL 3020  
Rojo  
Red
-  RAL 1018  
Amarillo  
Yellow
-  RAL DESIGN  
2108025  
Celeste  
Sky blue
-  RAL 4007  
Violeta  
Violet
-  RAL DESIGN  
3504035  
Rosa  
Pink
-  RAL 1001  
Beige  
Beige
-  RAL 6002  
Verde oscuro  
Green dark
-  RAL 9016  
Blanco  
White

8.

# VITRINA EXPOSITORA MODULAR FRÍO VENTILADO

## REFRIGERATED MODULAR DISPLAY CASE

Fotos no contractuales / Non contractual pictures



### VMD 25 R

[Decoración standard / Standard decoration]

MOD.

Costados Sides [2](mm)	Potencia Power [W]	Tensión Frecuencia Electrical [V/Hz]	Capacidad Capacity [L]	Puertas Doors	Superficie exposición [m²]	Estantes Shelving	Compresor Compressor [HP]	LED	Consumo Consumption [kWh/24h]	Evaporación Evaporation	Potencia frigorífica Cooling capacity [W a -10°C]	Desescarche Defrost	Control	Refrigerante Coolant
------------------------------	--------------------------	---	------------------------------	------------------	----------------------------------	----------------------	---------------------------------	-----	-------------------------------------	----------------------------	--	------------------------	---------	-------------------------

VMD 9 R/S	30+30	730	230/50	131	1	0,52	1	1/2	✓	10,2	Forzada Forced	817	Automático Automatic	Digital	R-452
VMD 12 R/S	30+30	980	230/50	175	2	0,69	1	5/8	✓	13,7	Forzada Forced	1096	Automático Automatic	Digital	R-452
VMD 15 R/S	30+30	1030	230/50	219	2	0,87	1	3/4	✓	14,4	Forzada Forced	1315	Automático Automatic	Digital	R-452
VMD 18 R/S	30+30	1260	230/50	263	3	1,04	1	1	✓	17,6	Forzada Forced	1506	Automático Automatic	Digital	R-452
VMD 25 R/S	30+30	1520	230/50	350	4	1,39	1	1+1/6	✓	21,3	Forzada Forced	2009	Automático Automatic	Digital	R-452
VMD 31 R/S	30+30	310	230/50	460	5	1,74	1	-	✓	4,3	Forzada Forced	2340	Automático Automatic	Digital	R-452
VMD 37 R/S	30+30	370	230/50	571	6	2,08	1	-	✓	5,2	Forzada Forced	2812	Automático Automatic	Digital	R-452

# SERIE MADRID SERIES



VMD 25 R

[Decoración standard / Standard decoration]

**Opciones y decoraciones pag. 321**

Options & decorations pag. 321

**VMD 9 R**

2.637 €

938x1150x1290 mm

Temp. 0°C/+6°C  
C. Clima. 4



**VMD 9 S**

2.594 €

**VMD 12 R**

2.952 €

1250x1150x1290 mm

Temp. 0°C/+6°C  
C. Clima. 4



**VMD 12 S**

2.841 €

**VMD 15 R**

3.209 €

1562x1150x1290 mm

Temp. 0°C/+6°C  
C. Clima. 4



**VMD 15 S**

3.194 €

**VMD 18 R**

3.709 €

1875x1150x1290mm

Temp. 0°C/+6°C  
C. Clima. 4



**VMD 18 S**

3.627 €

**VMD 25 R**

4.439 €

2500x1150x1290 mm

Temp. 0°C/+6°C  
C. Clima. 4

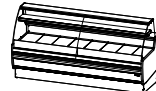

**VMD 25 S**

4.418 €

**VMD 31 R**

4.980 €

3125x1150x1290 mm

Temp. 0°C/+6°C  
C. Clima. 4

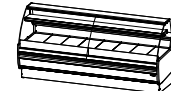

**VMD 31 S**

4.750 €

**VMD 37 R**

5.550 €

3750x1150x1290 mm

Temp. 0°C/+6°C  
C. Clima. 4



**VMD 37 S**

5.330 €

8.

# VITRINA EXPOSITORA MODULAR FRÍO VENTILADO

## REFRIGERATED MODULAR DISPLAY CASE

Fotos no contractuales / Non contractual pictures

VMD 90 AA R/S

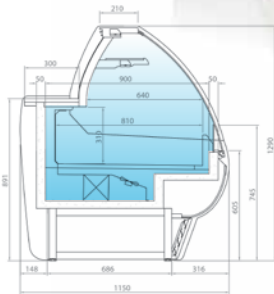



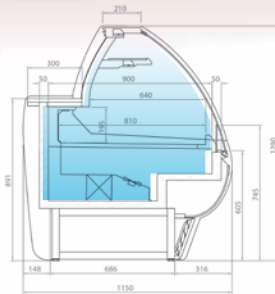









VMD R



VMD S

MOD.

														
	Costados Sides (2)(mm)	Potencia Power (W)	Tensión/Frecuencia Electrical (V/Hz)	Capacidad Capacity (L)	Puertas Doors	Superficie exposición (m <sup>2</sup> )	Estantes Shelving	Compresor Compressor (HP)	LED	Consumo Consumption (kWh/24h)	Evaporación Evaporation	Desescarche Defrost	Control	Refrigerante Coolant
VMD 90 AA R/S	30+30	990	230/50	-	-	1,15	1	5/8	✓	13,9	Forzada Forced	1096	Digital	R-452
VMD 45 AA R/S	30+30	670	230/50	-	-	0,63	1	3/8	✓	9,4	Forzada Forced	676	Digital	R-452
VMD 90 AC R/S	30+30	1060	230/50	-	-	1,49	1	3/4	✓	14,8	Forzada Forced	1315	Digital	R-452
VMD 45 AC R/S	30+30	740	230/50	-	-	0,75	1	1/2	✓	10,4	Forzada Forced	817	Digital	R-452

# SERIE MADRID SERIES

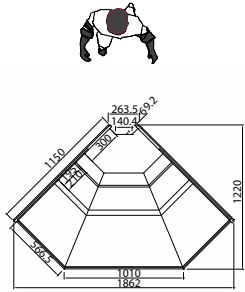

VMD 90 AA R

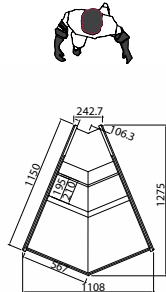

VMD 45 AA R

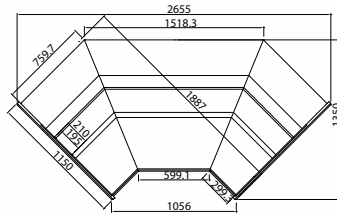

VMD 90 AC R

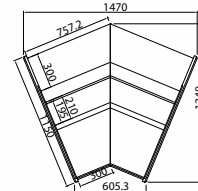

VMD 45 AC R



**VMD 90 AA R**

5.118 €

1326x1150x12900 mm

Temp. 0°C/+6°C  
C. Clima. 4



**VMD 90 AA S**

5.130 €

1326x1150x12900 mm

Temp. 0°C/+6°C  
C. Clima. 4

**VMD 45 AA R**

3.415 €

1108x1150x129 mm

Temp. 0°C/+6°C  
C. Clima. 4



**VMD 45 AA S**

3.422 €

1108x1150x129 mm

Temp. 0°C/+6°C  
C. Clima. 4

**VMD 90 AC R**

5.499 €

1887x1150x1290 mm

Temp. 0°C/+6°C  
C. Clima. 4

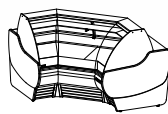

**VMD 90 AC S**

5.529 €

1887x1150x1290 mm

Temp. 0°C/+6°C  
C. Clima. 4

**VMD 45 AC R**

3.627 €

1470x1150x1290 mm

Temp. 0°C/+6°C  
C. Clima. 4

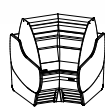

**VMD 45 AC S**

3.642 €

1470x1150x1290 mm

Temp. 0°C/+6°C  
C. Clima. 4

**MOD.**

VMD 90 AA

VMD 45 AA

VMD 90 AC

VMD 45 AC

**Puertas correderas traseras**

Rear sliding doors

[PUEV90AACT] 250 €

[PUEV45AACT] 174 €

[PUEV90ACCT] 125 €

[PUEV45ACCT] 87 €

8.

# VITRINA EXPOSITORA MODULAR FRÍO SEMIESTÁTICO









## SEMI-STATIC MODULAR DISPLAY CASE

Fotos no contractuales / Non contractual pictures



VMD 25 RE

MOD.

	 Costados Sides (2)(mm)	 Potencia Power (W)	 Tensión/Frecuencia Electrical (V/Hz)	 Superficie exposición (m²)	 Estantes Shelving	 Compresor Compressor (HP)	 LED	 Consumo Consumption (kWh/24h)	 Evaporación Evaporation	 Potencia frigorífica Cooling capacity (W a -10°C)	 Desescarche Defrost	 Control	 Refrigerante Coolant
VMD 9 RE	30+30	695	230/50	0,69	1	1/2	✓	9,7	Semiestática Semi-static	817	Automático Automatic	Digital	R-452
VMD 12 RE	30+30	945	230/50	0,93	1	5/8	✓	13,2	Semiestática Semi-static	1096	Automático Automatic	Digital	R-452
VMD 15 RE	30+30	995	230/50	1,16	1	3/4	✓	13,9	Semiestática Semi-static	1315	Automático Automatic	Digital	R-452
VMD 18 RE	30+30	1225	230/50	1,39	1	1	✓	17,2	Semiestática Semi-static	1506	Automático Automatic	Digital	R-452
VMD 25 RE	30+30	1485	230/50	1,85	1	1+1/6	✓	20,8	Semiestática Semi-static	2009	Automático Automatic	Digital	R-452

# SERIE MADRID SERIES



VMD 25RE

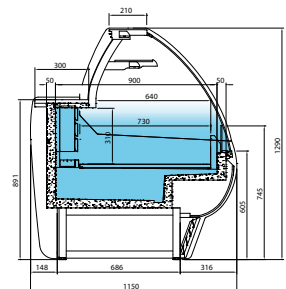

Opciones y decoraciones pag. 321  
Options & decorations pag. 321

**VMD 9 RE**

2.605 €

938x1150x1290 mm

Temp. 0°C/+6°C  
C. Clima. 4



**VMD 12 RE**

2.888 €

1250x1150x1290 mm

Temp. 0°C/+6°C  
C. Clima. 4



**VMD 15 RE**

3.210 €

1562x1150x1290 mm

Temp. 0°C/+6°C  
C. Clima. 4



**VMD 18 RE**

3.700 €

1875x1150x1290mm

Temp. 0°C/+6°C  
C. Clima. 4

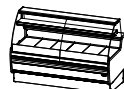

**VMD 25 SE**

4.391 €

2500x1150x1290 mm

Temp. 0°C/+6°C  
C. Clima. 4

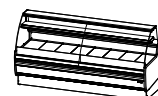

8.

# MUEBLE CAJA MOSTRADOR

## COUNTER CASE

Fotos no contractuales / Non contractual pictures



VMD 12 M



VMD 9 C

### CARACTERÍSTICAS TÉCNICAS TECHNICAL FEATURES

- Encimera de trabajo y apoya bolsos en acero inoxidable AISI 304
- Bancada en acero esmaltado
- Decoración en DM lacado
- Cuerpo y estantes traseros en madera estratificada blanca

- AISI 304 stainless steel worktop
- Base of enameled steel tubo
- DM lacqued decoration
- Structure and rear shelf white laminat wood

MOD.	Costados Sides (2)(mm)	Superficie exposición (m <sup>2</sup> )
VMD 9 C	30+30	0,55
VMD 12 M	30+30	0,74
VMD 15 M	30+30	0,92

#### VMD 9 C

1.401 €

938x1150x906 mm



#### VMD 12 M

1.538 €

1250x1150x906 mm



#### VMD 15 M

1.683 €

1562x1150x906 mm





# SERIE MADRID SERIES



-  RAL 4007  
Violeta  
Violet
-  RAL 2003  
Naranja  
Orange
-  RAL 5015  
Azul  
Blue
-  RAL 3003  
Granate  
Maroon
-  RAL 1018  
Amarillo  
Yellow
-  RAL DESIGN  
2108025  
Celeste  
Sky blue  
RAL 3020  
Rojo  
Red
-  RAL 1001  
Beige  
Beige
-  RAL 6002  
Verde oscuro  
Dark green
-  RAL DESIGN  
3504035  
Rosa  
Pink
-  RAL 9016  
Blanco  
White
-  RAL DESIGN  
1107060  
Pistacho  
Pistachio

## CARACTERÍSTICAS TÉCNICAS TECHNICAL FEATURES

- Chapa de acero plastificada
  - Encimera de trabajo en acero inox AISI 304
  - Cristal curvo securizado abatible
  - Bancada en acero esmaltado
  - Claro de puerta de acceso media reserva 425x255
  - Decoracion en DM lacado
  - Plano de exposición en acero inox AISI 304
  - Estante con iluminación LED
  - Bandeja evaporativa automática
- 
- Laminated steel plate
  - AISI 304 stainless steel worktop
  - Front opening curved tempered security glass system
  - Enamelled steel base
  - Storage door opening 425x255
  - DM lacqued decoration
  - AISI 304 exhibition area
  - LED lighting shelf "Grolux" type
  - Automatic evaporative tray

Otro color consultar precio  
Other colour consult price

## OPCIONES OPTIONS

MOD.	Puertas correderas traseras Rear sliding doors	Cortinas traseras nocturnas Night curtains	Doble plano (Sin reserva) Double surface (Without strage)	Lacado frontal + costados Frontal lacqued + sides
VMD 9	[PUEV9CT] 98 €	[CCNV9] 166 €	[DPEXVMDBC9S] 75 €	[DFCVMDVBC] 300 €
VMD 12	[PUEV12CT] 145€	[CCNV12] 220 €	[DPEXVMDBC12S] 100 €	[DFCVMDVBC] 300 €
VMD 15	[PUEV15CT] 196 €	[CCNV15] 256 €	[DPEXVMDBC15S] 125 €	[DFCVMDVBC] 300 €
VMD 18	[PUEV18CT] 244 €	[CCNV18] 285 €	[DPEXVMDBC18S] 150 €	[DFCVMDVBC] 300 €
VMD 25	[PUEV25CT] 297 €	[CCNV25] 332 €	[DPEXVMDBC25S] 200 €	[DFCVMDVBC] 300 €
VMD 31	[PUEV31CT] 293 €	[CCNV31] 513 €	[DPEXVMDBC31S] 250 €	[DFCVMDVBC] 300 €
VMD 37	[PUEV37CT] 488 €	[CCNV37] 570 €	[DPEXVMDBC37S] 300 €	[DFCVMDVBC] 300 €

# VITRINA EXPOSITORA MODULAR FRÍO VENTILADO REFRIGERATED MODULAR DISPLAY CASE

Fotos no contractuales / Non contractual pictures



VBC 15 R

## MOD.



Costados  
Sides  
(2)(mm)



Potencia  
Power  
(W)



Tensión  
Frecuencia  
Electrical  
(V/Hz)



Capacidad  
Capacity  
(L)



Puertas  
Doors



Superficie  
exposición  
(m<sup>2</sup>)



Estantes  
Shelving



Compresor  
Compressor  
(HP)



Consumo  
Consumption  
(kWh/24h)



Evaporación  
Evaporation



Potencia  
frigorífica  
Cooling capacity  
(W a -10°C)



Desescarche  
Defrost



Control



Refrigerante  
Coolant

MOD.	Costados Sides (2)(mm)	Potencia Power (W)	Tensión Frecuencia Electrical (V/Hz)	Capacidad Capacity (L)	Puertas Doors	Superficie exposición (m <sup>2</sup> )	Estantes Shelving	Compresor Compressor (HP)	Consumo Consumption (kWh/24h)	Evaporación Evaporation	Potencia frigorífica Cooling capacity (W a -10°C)	Desescarche Defrost	Control	Refrigerante Coolant
VBC 9 R	30+30	755	230/50	131	1	0,52	1	1/2	10,6	Forzada Forced	817	Automático Automatic	Digital	R-452
VBC 12 R	30+30	1015	230/50	175	2	0,59	1	5/8	14,2	Forzada Forced	1096	Automático Automatic	Digital	R-452
VBC 15 R	30+30	1070	230/50	219	2	0,87	1	3/4	15,0	Forzada Forced	1315	Automático Automatic	Digital	R-452
VBC 18 R	30+30	1310	230/50	263	3	1,04	1	1	18,3	Forzada Forced	1506	Automático Automatic	Digital	R-452
VBC 25 R	30+30	1585	230/50	350	4	1,39	1	1+1/6	22,2	Forzada Forced	2009	Automático Automatic	Digital	R-452
VBC 31 R/S	30+30	310	230/50	460	5	1,74	1		4,3	Forzada Forced	2340	Automático Automatic	Digital	R-452
VBC 37 R/S	30+30	370	230/50	571	6	2,08	1		5,2	Forzada Forced	2812	Automático Automatic	Digital	R-452

VITRINAS EXPOSITORAS DISPLAY CASES  
**SERIE BARCELONA SERIES**



VBC 15 R

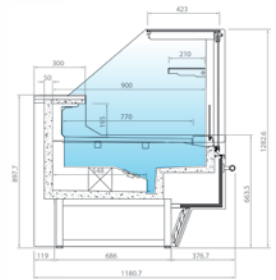

VBC S

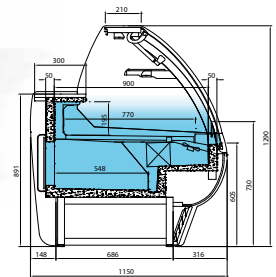

VBC R

Opciones y decoraciones pag. 335  
 Options & decorations pag. 335

VBC 9 R	VBC 12 R	VBC 15 R	VBC 18 R	VBC 25 R	VBC 31 R	VMD 37 R
3.146 €	3.472 €	3.867 €	4.426 €	5.378 €	6.075 €	6.380 €
938x1150x1290 mm	1250x1150x1290 mm	1562x1150x1290 mm	1875x1150x1290 mm	2500x1150x1290 mm	3125x1150x1290 mm	3750x1150x1290 mm
Temp. 0°C/+6°C C. Clima. 4	Temp. 0°C/+6°C C. Clima. 4	Temp. 0°C/+6°C C. Clima. 4	Temp. 0°C/+6°C C. Clima. 4	Temp. 0°C/+6°C C. Clima. 4	Temp. 0°C/+6°C C. Clima. 4	Temp. 0°C/+6°C C. Clima. 4
VBC 9 S	VBC 12 S	VBC 15 S	VBC 18 S	VBC 25 S	VMD 31 S	VMD 37 S
3.095 €	3.370 €	3.752 €	4.245 €	5.182 €	5.860 €	6.270 €

8.

# VITRINA EXPOSITORA MODULAR FRÍO SEMIESTÁTICO CON RESERVA

## SEMI STATIC WITH STORAGE















### MODULAR DISPLAY CASE

Fotos no contractuales / Non contractual pictures



VBC 15 RE

MOD.

	 Costados Slides (2)(mm)	 Potencia Power (W)	 Tensión Frecuencia Electrical (V/Hz)	 Capacidad Capacity (L)	 Puertas Doors	 Superficie exposición (m <sup>2</sup> )	 Estantes Shelving	 Compresor Compressor (HP)	 Consumo Consumption (kWh/24h)	 Evaporación Evaporation	 Potencia frigorífica Cooling capacity (W a -10°C)	 Desescarche Defrost	 Control	 Refrigerante Coolant
VBC 9 RE	30+30	740	230/50	197	1	0,72	1 + 1 OPC.	1/2	10,6	Semi Estática Semi Static	817	Automático Automatic	Digital	R-452
VBC 12 RE	30+30	1000	230/50	263	2	0,96	1 + 1 OPC.	5/8	14,2	Semi Estática Semi Static	1096	Automático Automatic	Digital	R-452
VBC 15 RE	30+30	1055	230/50	328	2	1,20	1 + 1 OPC.	3/4	15,0	Semi Estática Semi Static	1315	Automático Automatic	Digital	R-452
VBC 18 RE	30+30	1295	230/50	394	3	1,44	1 + 1 OPC.	1	18,3	Semi Estática Semi Static	1506	Automático Automatic	Digital	R-452
VBC 25 RE	30+30	1570	230/50	525	4	1,93	1 + 1 OPC.	1+1/6	22,2	Semi Estática Semi Static	2009	Automático Automatic	Digital	R-452

# VITRINAS EXPOSITORAS DISPLAY CASES

## SERIE BARCELONA SERIES



VBC 15 RE

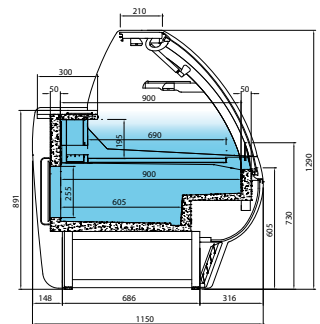

**Opciones y decoraciones pag. 335**  
Options & decorations pag. 335

### VBC 9 RE

**3.131 €**

938x1150x1290 mm

Temp. 0°C/+6°C  
C. Clima. 4

### VBC 12 RE

**3.454 €**

1250x1150x1290 mm

Temp. 0°C/+6°C  
C. Clima. 4

### VBC 15 RE

**3.804 €**

1562x1150x1290 mm

Temp. 0°C/+6°C  
C. Clima. 4

### VBC 18 RE

**4.346 €**

1875x1150x1290 mm

Temp. 0°C/+6°C  
C. Clima. 4

### VBC 25 RE

**5.239 €**

2500x1150x1290 mm

Temp. 0°C/+6°C  
C. Clima. 4

### VBC 15 RE

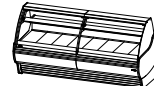

# VITRINA EXPOSITORA MODULAR FRÍO VENTILADO CON RESERVA

## REFRIGERATED WITH STORAGE MODULAR DISPLAY CASE



VBC 90 AA R

## MOD.



Costados  
Sides  
(2)(mm)



Potencia  
Power  
(W)



Tensión/Frecuencia  
Electrical  
(V/Hz)



Superficie  
exposición  
(m<sup>2</sup>)



Estantes  
Shelving



Compresor  
Compressor  
(HP)



Consumo  
Consumption  
(kWh/24h)



Evaporación  
Evaporation



Potencia  
frigorífica  
Cooling capacity  
(W a -10°C)



Desescarche  
Defrost



Control



Refrigerante  
Coolant

	Costados Sides (2)(mm)	Potencia Power (W)	Tensión/Frecuencia Electrical (V/Hz)	Superficie exposición (m <sup>2</sup> )	Estantes Shelving	Compresor Compressor (HP)	Consumo Consumption (kWh/24h)	Evaporación Evaporation	Potencia frigorífica Cooling capacity (W a -10°C)	Desescarche Defrost	Control	Refrigerante Coolant
VBC 90 AA R/S	30+30	1025	230/50	1,09	1 + 1 OPC.	5/8	13,9	Forzada Forced	1096	Automático Automatic	Digital	R-452
VBC 45 AA R/S	30+30	700	230/50	0,60	1 + 1 OPC.	3/8	9,4	Forzada Forced	676	Automático Automatic	Digital	R-452
VBC 90 AC R/S	30+30	1110	230/50	1,43	1 + 1 OPC.	3/4	14,8	Forzada Forced	1315	Automático Automatic	Digital	R-452
VBC 45 AC R/S	30+30	780	230/50	0,72	1 + 1 OPC.	1/2	10,4	Forzada Forced	817	Automático Automatic	Digital	R-452

# VITRINAS EXPOSITORAS DISPLAY CASES

## SERIE BARCELONA SERIES



VBC 90 AA R



VBC 45 AA R

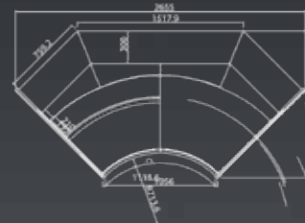

VBC 90 AC R



VBC 45 AC R

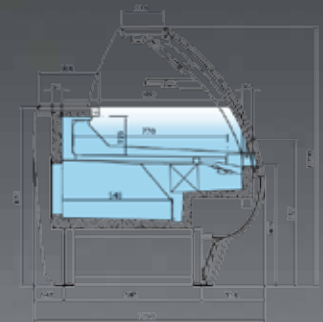

### VBC 90 AA R

6.336 €

1326x1150x1290 mm

Temp. 0°C/+6°C  
C. Clima. 4

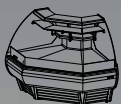

### VBC 90 AA S

6.246 €

### VBC 45 AA R

4.760 €

1108x1150x1290 mm

Temp. 0°C/+6°C  
C. Clima. 4



### VBC 45 AA S

4.722 €

### VBC 90 AC R

7.611 €

1887x1150x1290 mm

Temp. 0°C/+6°C  
C. Clima. 4

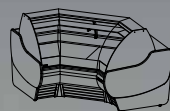

### VBC 90 AC S

7.441 €

### VBC 45 AC R

4.749 €

1470x1150x1290 mm

Temp. 0°C/+6°C  
C. Clima. 4



### VBC 45 AC S

4.690 €

### OPCIONES OPTIONS

#### MOD.

Puertas correderas traseras  
Rear sliding doors

VBC 90 AA	[PUEV90AACT] 250 €
VBC 45 AA	[PUEV45AACT] 174 €
VBC 90 AC	[PUEV90ACCT] 125 €
VBC 45 AC	[PUEV45ACCT] 87 €

8.

# VITRINA EXPOSITORA MODULAR FRÍO VENTILADO

## REFRIGERATED MODULAR DISPLAY CASE

Fotos no contractuales / Non contractual pictures



VBC 12 RCP

MOD.

Costados Slides (2)(mm)	Potencia Power (W)	Tensión Frecuencia Electrical (V/Hz)	Capacidad Capacity (L)	Puertas Doors	Superficie exposición (m <sup>2</sup> )	Estantes Shelving	Compresor Compressor (HP)	Consumo Consumption (kWh/24h)	Evaporación Evaporation	Potencia frigorífica Cooling capacity (W a -10°C)	Desescarche Defrost	Control	Refrigerante Coolant
-------------------------------	--------------------------	---	------------------------------	------------------	---	----------------------	---------------------------------	-------------------------------------	----------------------------	--	------------------------	---------	-------------------------

VBC 9 RCP/SCP	30+30	755	230/50	131	1	0,52	1	1/2	10,6	Forzada Forced	817	Automático Automatic	Digital	R-452
VBC 12 RCP/SCP	30+30	1015	230/50	175	2	0,69	1	5/8	14,2	Forzada Forced	1096	Automático Automatic	Digital	R-452
VBC 15 RCP/SCP	30+30	1070	230/50	219	2	0,87	1	3/4	15,0	Forzada Forced	1315	Automático Automatic	Digital	R-452
VBC 18 RCP/SCP	30+30	1310	230/50	263	3	1,04	1	1	18,3	Forzada Forced	1506	Automático Automatic	Digital	R-452
VBC 25 RCP/SCP	30+30	1585	230/50	350	4	1,39	1	1+1/6	22,2	Forzada Forced	2009	Automático Automatic	Digital	R-452
VBC 31 RCP/SCP	30+30	310	230/50	460	5	1,74	1		4,3	Forzada Forced	2340	Automático Automatic	Digital	R-452
VBC 37 RCP/SCP	30+30	370	230/50	571	6	2,08	1		5,2	Forzada Forced	2812	Automático Automatic	Digital	R-452



# VITRINAS EXPOSITORAS DISPLAY CASES

## SERIE BARCELONA SERIES



VBC 12 SCP

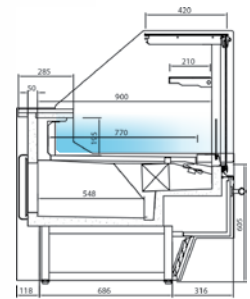

[R] CON RESERVA  
WITH STORAGE

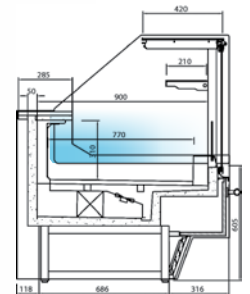

[S] SIN RESERVA  
WITHOUT STORAGE

**Opciones y decoraciones pag. 335**

Options & decorations pag. 335

**VBC 9 RCP**

3.434 €

938x1150x1290 mm

Temp. 0°C/+6°C  
C. Clima. 4



**VBC 9 SCP**

3.342 €

938x1150x1290 mm

Temp. 0°C/+6°C  
C. Clima. 4

**VBC 12 RCP**

3.781 €

1250x1150x1290 mm

Temp. 0°C/+6°C  
C. Clima. 4



**VBC 12 SCP**

3.693 €

1250x1150x1290 mm

Temp. 0°C/+6°C  
C. Clima. 4

**VBC 15 RCP**

4.171 €

1562x1150x1290 mm

Temp. 0°C/+6°C  
C. Clima. 4



**VBC 15 SCP**

4.074 €

1562x1150x1290 mm

Temp. 0°C/+6°C  
C. Clima. 4

**VBC 18 RCP**

4.788 €

1875x1150x1290 mm

Temp. 0°C/+6°C  
C. Clima. 4



**VBC 18 SCP**

4.561 €

1875x1150x1290 mm

Temp. 0°C/+6°C  
C. Clima. 4

**VBC 25 RCP**

5.906 €

2500x1150x1290 mm

Temp. 0°C/+6°C  
C. Clima. 4

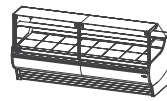

**VBC 25 SCP**

5.614 €

2500x1150x1290 mm

Temp. 0°C/+6°C  
C. Clima. 4

**VBC 31 RCP**

6.295 €

3125x1150x1290 mm

Temp. 0°C/+6°C  
C. Clima. 4

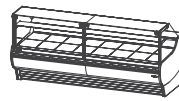

**VMD 31 SCP**

6.067 €

3125x1150x1290 mm

Temp. 0°C/+6°C  
C. Clima. 4

**VMD 37 RCP**

6.600 €

3750x1150x1290 mm

Temp. 0°C/+6°C  
C. Clima. 4

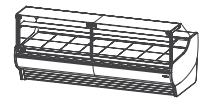

**VMD 37 SCP**

6.490 €

3750x1150x1290 mm

Temp. 0°C/+6°C  
C. Clima. 4

8.

# VITRINA EXPOSITORA MODULAR FRÍO VENTILADO ÁNGULO RECTO

## REFRIGERATED MODULAR CASE RIGHT ANGLE

Fotos no contractuales / Non contractual pictures

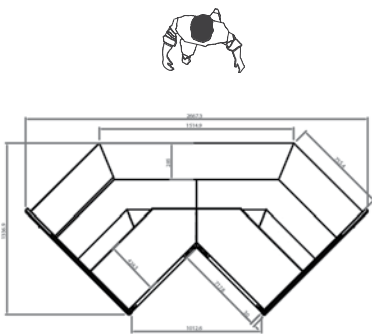

VBC 90 AC RCP/SCP

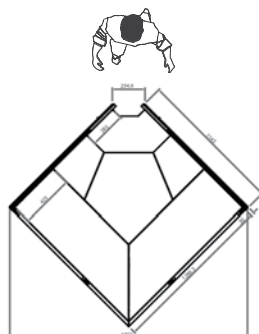

VBC 90 AA RCP/SCP

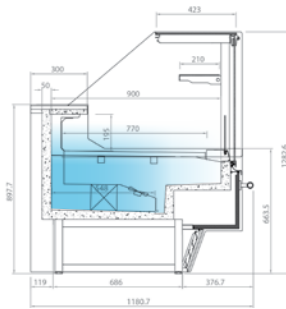

[R]  
CON RESERVA  
WITH STORAGE

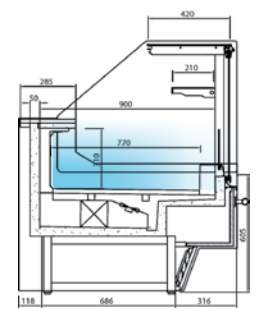

[S]  
SIN RESERVA  
WITHOUT STORAGE

MOD.

	Costados Sides [2](mm)	Potencia Power [W]	Tensión/Frecuencia Electrical [V/Hz]	Superficie exposición [m <sup>2</sup> ]	Estantes Shelving	Compresor Compressor [HP]	Consumo Consumption [kWh/24h]	Evaporación Evaporation	Potencia frigorífica Cooling capacity [W a -10°C]	Desescarche Defrost	Control	Refrigerante Coolant
VBC 90 AC RCP/SCP	30+30	1025	230/50	1,09	1	5/8	13,9	Forzada Forced	1096	Automático Automatic	Digital	R-452
VBC 90 AA RCP/SCP	30+30	1110	230/50	1,43	1	3/4	14,8	Forzada Forced	1315	Automático Automatic	Digital	R-452

# VITRINAS EXPOSITORAS DISPLAY CASES

## SERIE BARCELONA SERIES



VBC 90 AA R SCP

Opciones y decoraciones pag. 335  
Options & decorations pag. 335

### VBC90 AAR RCP

6.653 €

1887x1150x1290 mm

Temp. 0°C/+6°C  
C. Clima. 4



### VBC90 ACR RCP

7.992 €

1326x1150x1290 mm

Temp. 0°C/+6°C  
C. Clima. 4



### VBC 90 AAR SCP

6.558€

1887x1150x1290 mm

Temp. 0°C/+6°C  
C. Clima. 4



### VBC 90 ACR SCP

7.813 €

1326x1150x1290 mm

Temp. 0°C/+6°C  
C. Clima. 4



### OPCIONES OPTIONS

#### MOD.

VBC 90 AA

VBC 90 AC

Puertas correderas traseras  
Rear sliding doors

[PUEV90AACTCP] 250 €

[PUEV90ACCTCP] 125 €

# VITRINA EXPOSITORA MODULAR FRÍO VENTILADO AUTOSERVICIO

## REFRIGERATED MODULAR SELF SERVICE CASE







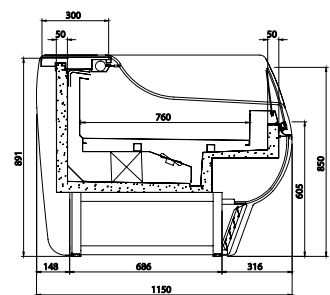
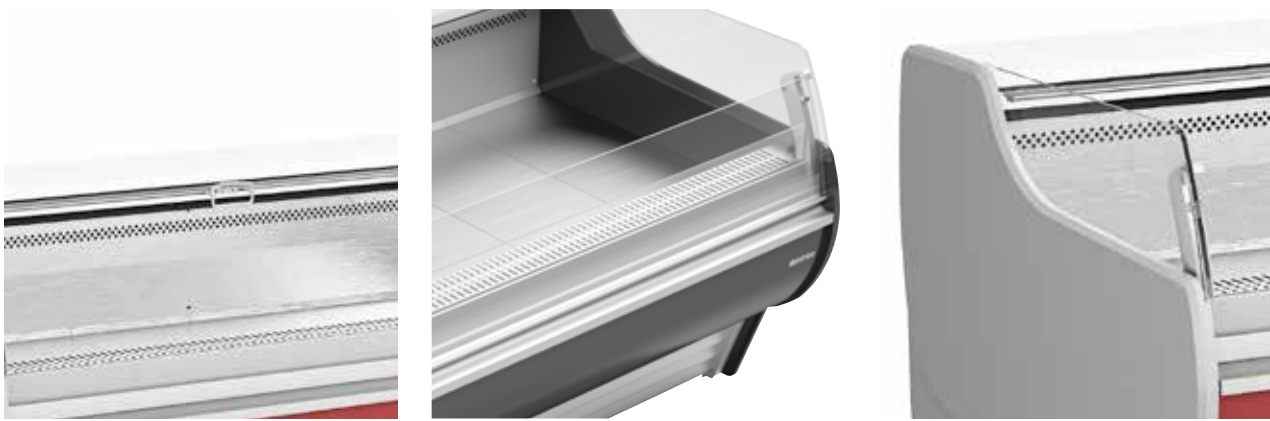



Fotos no contractuales / Non contractual pictures

### VBC15SCB

[Cortina nocturna de serie / Standard night curtain]



#### MOD.

	 Costados Sides [2](mm)	 Potencia Power [W]	 Tensión Frecuencia Electrical [V/Hz]	 Capacidad Capacity [L]	 Puertas Doors	 Superficie exposición [m <sup>2</sup> ]	 Compresor Compressor [HP]	 Consumo Consumption [kWh/24h]	 Evaporación Evaporation	 Potencia frigorífica Cooling capacity [W a -10°C]	 Desescarche Defrost	 Control	 Refrigerante Coolant
<b>VBC 9 SCB</b>	30+30	755	230/50	131	1	0,72	1/2	10,6	Forzada Forced	817	Automático Automatic	Digital	R-452
<b>VBC 12 SCB</b>	30+30	1015	230/50	175	2	0,96	5/8	14,2	Forzada Forced	1096	Automático Automatic	Digital	R-452
<b>VBC 15 SCB</b>	30+30	1070	230/50	219	2	1,20	3/4	15,0	Forzada Forced	1315	Automático Automatic	Digital	R-452
<b>VBC 18 SCB</b>	30+30	1310	230/50	263	3	1,44	1	18,3	Forzada Forced	1506	Automático Automatic	Digital	R-452
<b>VBC 25 SCB</b>	30+30	1585	230/50	350	4	1,93	1+1/6	22,2	Forzada Forced	2009	Automático Automatic	Digital	R-452

# VITRINAS EXPOSITORAS DISPLAY CASES

## SERIE BARCELONA SERIES



### VBC 18

- Chapa de acero plastificada
- Encimera de trabajo en acero inox AISI 304
- Decoracion en DM lacado con iluminación LED
- Plano de exposición en Acero Inox AISI 304
- Cortina nocturna
- Bandeja evaporativa automática
- Desescarche gas caliente

- Laminated steel plate
- AISI 304 stainless steel worktop
- DM lacqued decoration with LED lighting
- Enameled exhibition steel surface
- Night curtain
- Automatic evaporative tray
- Hot gas defrost

#### VBC 9 SCB

2.883 €

938x1150x905mm

Temp. 0°C/+6°C  
C. Clima. 3

#### VBC 12 SCB

3.125 €

1250x1150x905 mm

Temp. 0°C/+6°C  
C. Clima. 3

#### VBC 15 SCB

3.601 €

1562x1150x905 mm

Temp. 0°C/+6°C  
C. Clima. 3

#### VBC 18 SCB

3.925 €

1875x1150x905 mm

Temp. 0°C/+6°C  
C. Clima. 3

#### VBC 25 SCB

4.781 €

2500x1150x905mm

Temp. 0°C/+6°C  
C. Clima. 3

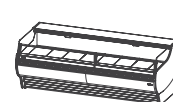
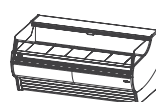
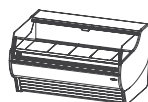

8.

# MUEBLE CAJA MOSTRADOR COUNTER CASE

Fotos no contractuales / Non contractual pictures

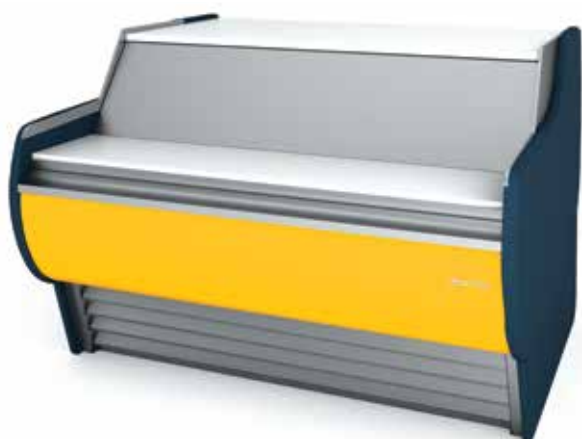

VBC 12 M

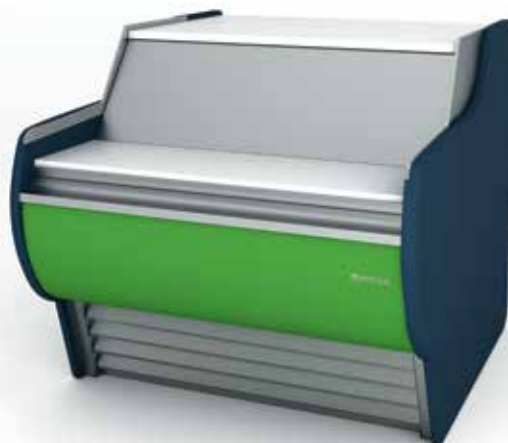

VBC 9 C

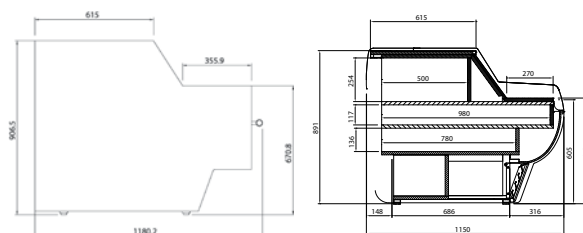

VBC P

VBC

**VBC 9 C**

1.235 €

938x1150x906 mm



**VBC 9 CP**

1.235 €

938x1150x906 mm



**VBC 12 M**

1.329 €

1250x1150x906 mm



**VBC 12 MP**

1.329 €

1250x1150x906 mm



**VBC 15 M**

1.481 €

1562x1150x906 mm



**VBC 15 MP**

1.481 €

1562x1150x906 mm

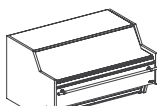

**VBC 12 MHD**

1.400 €

1250x1150x906 mm



**VBC 12 MHDP**

1.400 €

1250x1150x906 mm

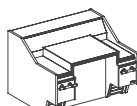

**MOD.**

 Costados / Sides  
(2)[mm]











 Superficie exposición  
(m<sup>2</sup>)

VBC 9 C	30+30	0,55
VBC 12 M	30+30	0,74
VBC 15 M	30+30	0,92

# VITRINAS EXPOSITORAS DISPLAY CASES

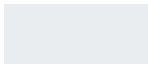
## SERIE BARCELONA SERIES



	RAL 4007 Violeta Violet
	RAL 2003 Naranja Orange
	RAL 5015 Azul Blue
	RAL 3003 Granate Maroon
	RAL 1018 Amarillo Yellow
	RAL DESIGN 2108025 Celeste Sky blue
	RAL 3020 Rojo Red
	RAL 9016 Blanco White
	RAL 6002 Verde oscuro Green dark
	RAL DESIGN 3504035 Rosa Pink
	RAL DESIGN 1107060 Pistacho Pistachio

### CARACTERÍSTICAS TÉCNICAS TECHNICAL FEATURES

- Bancada en acero esmaltado
- Chapa de acero plastificada
- Encimera de trabajo en acero inox AISI 304
- Cristal securizado elevable
- Claro de puerta de acceso media reserva 425x255
- Decoracion en DM lacado con iluminación LED
- Plano de exposición en acero inox AISI 304
- Iluminación LED
- Estante con iluminación LED
- Bandeja evaporativa automática

- Base of enameled steel tubo
- Laminated steel plate
- AISI 304 stainless steel worktop
- Lift-up tempered security glass system
- Storage door opening 425x255
- DM lacqued decoration with LED lighting
- AISI 304 exhibition area
- LED lighting
- LED lighting shelf
- Automatic evaporative tray

Otro color consultar precio  
Other colour consult price

### OPCIONES OPTIONS

MOD.	Puertas correderas traseras Rear sliding doors	Cortinas traseras nocturnas Night curtains	Cristal calefactado Heated frontal glass
VBC 9	[PUEV9CT] 98 €	[CCNV9] 166 €	300 €
VBC 9 P	[PUEV9CTCP] 98 €		
VBC 12	[PUEV12CT] 145 €	[CCNV12] 220 €	311 €
VBC 12 P	[PUEV12CTCP] 145 €		
VBC 15	[PUEV15CT] 196 €	[CCNV15] 256 €	321 €
VBC 15 P	[PUEV15CTCP] 196 €		
VBC 18	[PUEV18CT] 244 €	[CCNV18] 285 €	342 €
VBC 18 P	[PUEV18CTCP] 244 €		
VBC 25	[PUEV25CT] 297 €	[CCNV25] 332 €	621 €
VBC 25 P	[PUEV25CTCP] 297 €		
VBC 31	[PUEV31CT] 293 €	[CCNV31] 513 €	624 €
VBC 31 P	[PUEV31CTCP] 293 €		
VBC 37	[PUEV37CT] 488 €	[CCNV37] 570 €	684 €
VBC 37 P	[PUEV37CTCP] 488 €		

8.

# VITRINA EXPOSITORA MODULAR FRÍO VENTILADO

## REFRIGERATED MODULAR DISPLAY CASE



8



VITRINAS EXPOSITORAS DISPLAY CASES

## SERIE EUROPA SERIES



- Chapa de acero plastificada
- Encimera de trabajo en acero inox AISI 304
- Cristal securizado elevable
- Bancada en acero esmaltado
- Claro de puerta de acceso media reserva 425x225
- Decoracion en DM lacado con iluminación LED
- Plano de exposición esmaltado
- Iluminación LED
- Bandeja evaporativa automática

- Laminated steel plate
- AISI 304 stainless steel worktop
- Lift-up tempered security glass system
- Enamelled steel base
- Storage door opening 425x225
- DM lacqued decoration with LED lighting
- Enameled exhibition steel surface
- LED lighting
- Automatic evaporative tray

8.

# VITRINA EXPOSITORA MODULAR FRÍO VENTILADO











## REFRIGERATED MODULAR DISPLAY CASE

Fotos no contractuales / Non contractual pictures



VEU 18 RCP

MOD.

	 Costados Sides [2](mm)	 Potencia Power [W]	 Tensión/Frecuencia Electrical [V/Hz]	 Capacidad Capacity [L]	 Puertas Doors	 Superficie exposición [m²]	 Compresor Compressor [HP]	 Consumo Consumption [kWh/24h]	 Evaporación Evaporation	 Potencia frigorífica Cooling capacity [W a -10°C]	 Desescarche Defrost	 Control	 Refrigerante Coolant
<b>VEU 9 R/RCP</b>	30+30	755	230/50	159	1	0,86	1/2	10,6	Forzada Forced	817	Automático Automatic	Digital	R-452
<b>VEU 12 R/RCP</b>	30+30	1015	230/50	213	2	1,14	5/8	14,2	Forzada Forced	1096	Automático Automatic	Digital	R-452
<b>VEU 15 R/RCP</b>	30+30	1070	230/50	266	2	1,43	3/4	15,0	Forzada Forced	1315	Automático Automatic	Digital	R-452
<b>VEU 18 R/RCP</b>	30+30	1310	230/50	319	3	1,72	1	18,3	Forzada Forced	1506	Automático Automatic	Digital	R-452
<b>VEU 25 R/RCP</b>	30+30	1585	230/50	425	4	2,29	1+1/6	22,2	Forzada Forced	2009	Automático Automatic	Digital	R-452
<b>VEU 31 R/RCP</b>	40+40	310	230/50	531	5	2,86	-	4,3	Forzada Forced	2600	Automático Automatic	Digital	R-452
<b>VEU 37 R/RCP</b>	40+40	370	230/50	638	6	3,43	-	5,2	Forzada Forced	3000	Automático Automatic	Digital	R-452

# SERIE EUROPA SERIES



## VEU 18 R

**Decoración standard**  
Standard decoration

**Opciones y decoraciones pag. 349**  
Options & decorations pag. 349

### VEU 9 R

**3.537 €**

938x1285x1310 mm

Temp. 0°C/+6°C  
C. Clima. 4



### VEU 12 R

**3.873 €**

1250x1285x1310 mm

Temp. 0°C/+6°C  
C. Clima. 4



### VEU 15 R

**4.169 €**

1562x1285x1310 mm

Temp. 0°C/+6°C  
C. Clima. 4



### VEU 18 R

**4.600 €**

1875x1285x1310 mm

Temp. 0°C/+6°C  
C. Clima. 4

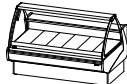

### VEU 25 R

**5.491 €**

2500x1285x1310 mm

Temp. 0°C/+6°C  
C. Clima. 4

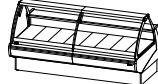

### VEU 31 R

**6.130 €**

3125x1285x1310 mm

Temp. 0°C/+6°C  
C. Clima. 4

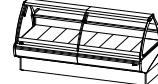

### VEU 37 R

**6.436 €**

3750x1285x1310 mm

Temp. 0°C/+6°C  
C. Clima. 4



### VEU 9 RCP

**3.600 €**

938x1285x1310mm

Temp. 0°C/+6°C  
C. Clima. 4



### VEU 12 RCP

**3.920 €**

1250x1285x1310 mm

Temp. 0°C/+6°C  
C. Clima. 4



### VEU 15 RCP

**4.301 €**

1562x1285x1310mm

Temp. 0°C/+6°C  
C. Clima. 4

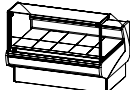

### VEU 18 RCP

**4.733 €**

1875x1285x1310 mm

Temp. 0°C/+6°C  
C. Clima. 4

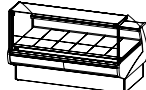

### VEU 25 RCP

**5.592 €**

2500x1285x1310 mm

Temp. 0°C/+6°C  
C. Clima. 4

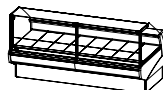

### VEU 31 RCP

**6.208 €**

3125x1285x1310 mm

Temp. 0°C/+6°C  
C. Clima. 4

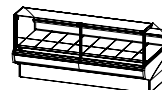

### VEU 37 RCP

**6.770 €**

3750x1285x1310 mm

Temp. 0°C/+6°C  
C. Clima. 4

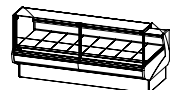

8.

# VITRINA EXPOSITORA MODULAR FRÍO VENTILADO

## REFRIGERATED MODULAR DISPLAY CASE

Fotos no contractuales / Non contractual pictures



### ANGULOS RECTOS RIGHT ANGLES

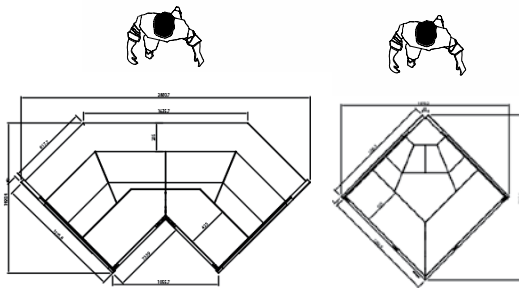

VEU 90 ACR RCP

VEU 90 AAR RCP

#### MOD.



Costados  
Sides  
(2)(mm)



Potencia  
Power  
(W)



Tensión/Frecuencia  
Electrical  
(V/Hz)



Capacidad  
Capacity  
(L)



Puertas  
Doors



Superficie  
exposición  
(m<sup>2</sup>)



Compresor  
Compressor  
(HP)



Consumo  
Consumption  
(kWh/24h)



Evaporación  
Evaporation



Potencia  
frigorífica  
Cooling capacity  
(W a -10°C)



Desescarche  
Defrost



Control



Refrigerante  
Coolant

MOD.	Costados Sides (2)(mm)	Potencia Power (W)	Tensión/Frecuencia Electrical (V/Hz)	Capacidad Capacity (L)	Puertas Doors	Superficie exposición (m <sup>2</sup> )	Compresor Compressor (HP)	Consumo Consumption (kWh/24h)	Evaporación Evaporation	Potencia frigorífica Cooling capacity (W a -10°C)	Desescarche Defrost	Control	Refrigerante Coolant
VEU 90 AA R /RCP	40+40	1025	230/50	-	-	1,10	5/8	14,4	Forzada Forced	1096	Automático Automatic	Digital	R-452
VEU 45 AA R	40+40	700	230/50	-	-	0,60		0,5	Forzada Forced		Automático Automatic	Digital	R-452
VEU 90 AC R /RCP	40+40	1110	230/50	-	-	1,85	3/4	15,5	Forzada Forced	1315	Automático Automatic	Digital	R-452
VEU 45 AC R	40+40	780	230/50	-	-	0,92	1/2	10,9	Forzada Forced	817	Automático Automatic	Digital	R-452

# SERIE EUROPA SERIES

## ANGULOS CURVOS CURVED ANGLES

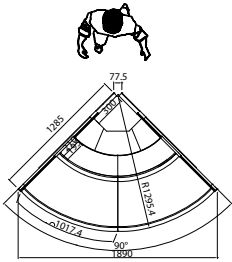

VEU 90 AA R

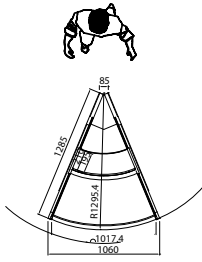

VEU 45 AA RN

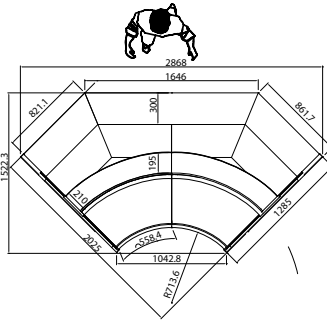

VEU 90 AC R

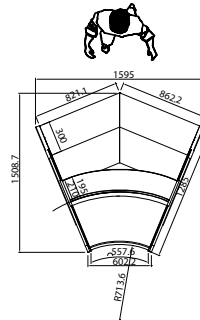

VEU 45 AC R

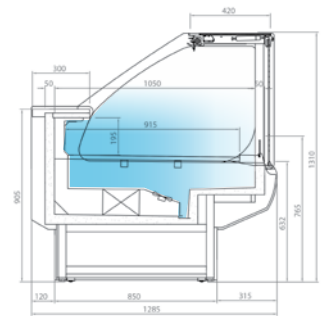

[R]  
CON RESERVA  
WITH STORAGE

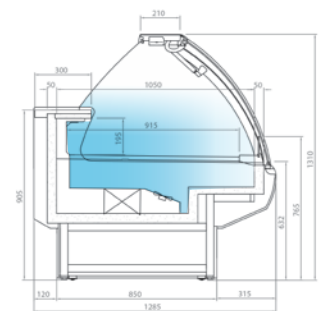

[R]  
CON RESERVA  
WITH STORAGE

VEU 90 AA R

### VEU 90 AA R

6.203 €

1326x1285x1310 mm

Temp. 0°C/+6°C  
C. Clima. 4



### VEU 45 AA R

3.761 €

1108x1285x1310 mm

Temp. 0°C/+6°C  
C. Clima. 4



### VEU 90 AC R

8.124 €

1887x1285x1310 mm

Temp. 0°C/+6°C  
C. Clima. 4



### VEU 45 AC R

5.008 €

1285x1150x1310 mm

Temp. 0°C/+6°C  
C. Clima. 4



### VEU 90 AAR RCP

6.653 €

1285x1150x1310 mm

Temp. 0°C/+6°C  
C. Clima. 4

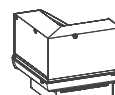

### VEU 90 ACR RCP

7.992€

1887x1285x1310 mm

Temp. 0°C/+6°C  
C. Clima. 4

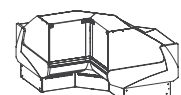

8.

# VITRINA EXPOSITORA MODULAR FRÍO VENTILADO SIN RESERVA

## REFRIGERATED WITHOUT STORAGE MODULAR DISPLAY CASE

Fotos no contractuales / Non contractual pictures



VEU 18 SCP

MOD.

	 Costados Sides (2)(mm)	 Potencia Power (W)	 Tensión/Fre- cuencia Electrical (V/Hz)	 Superficie expo- sición (m <sup>2</sup> )	 Compresor Compressor (HP)	 Consumo Consumption (kWh/24h)	 Evaporación Evaporation	 Potencia frigorífica Cooling capacity (W a -10°C)	 Desescarche Defrost	 Control	 Refrigerante Coolant
--	--	--	---	---	---	---	--	--	--	---	---

VEU 9 S/SCP	40+40	755	230/50	0,86	1/2	10,6	Forzada Forced	817	Automático Automatic	Digital	R-452
VEU 12 S/SCP	40+40	1015	230/50	1,14	5/8	14,2	Forzada Forced	1096	Automático Automatic	Digital	R-452
VEU 15 S/SCP	40+40	1070	230/50	1,43	3/4	15,0	Forzada Forced	1315	Automático Automatic	Digital	R-452
VEU 18 S/SCP	40+40	1310	230/50	1,72	1	18,3	Forzada Forced	1506	Automático Automatic	Digital	R-452
VEU 25 S/SCP	40+40	1585	230/50	2,29	1+1/6	22,2	Forzada Forced	2009	Automático Automatic	Digital	R-452
VEU 31 S/SCP	40+40	310	230/50	2,86	-	4,3	Forzada Forced	2600	Automático Automatic	Digital	R-452
VEU 37 S/SCP	40+40	370	230/50	3,43	-	5,2	Forzada Forced	3000	Automático Automatic	Digital	R-452

# SERIE EUROPA SERIES



VEU 18 S

**Opciones y decoraciones pag. 349**

Options & decorations pag. 349

**VEU 9 S**

3.417 €

938x1285x1310 mm

Temp. 0°C/+6°C  
C. Clima. 4



**VEU 12 S**

3.754 €

1250x1285x1310 mm

Temp. 0°C/+6°C  
C. Clima. 4



**VEU 15 S**

4.047 €

1562x1285x1310 mm

Temp. 0°C/+6°C  
C. Clima. 4



**VEU 18 S**

4.442 €

1875x1285x1310 mm

Temp. 0°C/+6°C  
C. Clima. 4

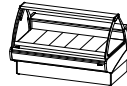

**VEU 25 S**

5.282 €

2500x1285x1310 mm

Temp. 0°C/+6°C  
C. Clima. 4



**VEU 31 S**

5.863 €

3125x1285x1310 mm

Temp. 0°C/+6°C  
C. Clima. 4

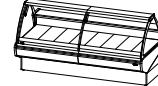

**VEU 37 S**

6.398 €

3750x1285x1310 mm

Temp. 0°C/+6°C  
C. Clima. 4

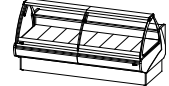

**VEU 9 SCP**

3.507 €

938x1285x1310 mm

Temp. 0°C/+6°C  
C. Clima. 4



**VEU 12 SCP**

3.782 €

1250x1285x1310 mm

Temp. 0°C/+6°C  
C. Clima. 4



**VEU 15 SCP**

4.174 €

1562x1285x1310 mm

Temp. 0°C/+6°C  
C. Clima. 4

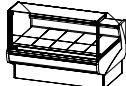

**VEU 18 SCP**

4.544 €

1875x1285x1310 mm

Temp. 0°C/+6°C  
C. Clima. 4

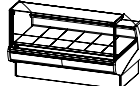

**VEU 25 SCP**

5.371 €

2500x1285x1310 mm

Temp. 0°C/+6°C  
C. Clima. 4

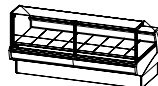

**VEU 31 SCP**

6.004 €

3125x1285x1310 mm

Temp. 0°C/+6°C  
C. Clima. 4

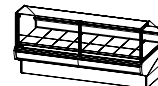

**VEU 37 SCP**

6.554 €

3750x1285x1310 mm

Temp. 0°C/+6°C  
C. Clima. 4

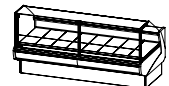

8.

# VITRINA EXPOSITORA MODULAR FRÍO VENTILADO SIN RESERVA

## REFRIGERATED WITHOUT STORAGE MODULAR DISPLAY CASE

Fotos no contractuales / Non contractual pictures



### ANGULOS CURVOS CURVED ANGLES

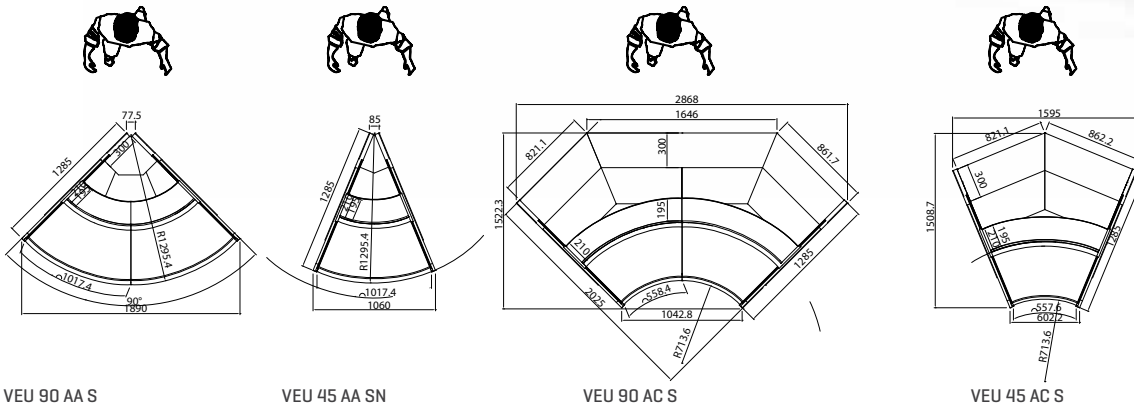

VEU 90 AA S

VEU 45 AA SN

VEU 90 AC S

VEU 45 AC S

MOD.	Costados Sides (2)(mm)	Potencia Power (W)	Tensión/Frecuencia Electrical (V/Hz)	Capacidad Capacity (L)	Puertas Doors	Superficie exposición (m <sup>2</sup> )	Compresor Compressor (HP)	Consumo Consumption (kWh/24h)	Evaporación Evaporation	Potencia frigorífica Cooling capacity (W a -10°C)	Desescarche Defrost	Control	Refrigerante Coolant
VEU 90 AA S /SCP	40+40	1025	230/50	-	-	1,10	5/8	14,4	Forzada Forced	1096	Automático Automatic	Digital	R-452
VEU 45 AA S	40+40	700	230/50	-	-	0,60	-	0,5	Forzada Forced	-	Automático Automatic	Digital	R-452
VEU 90 AC S /SCP	40+40	1110	230/50	-	-	1,85	3/4	15,5	Forzada Forced	1315	Automático Automatic	Digital	R-452
VEU 45 AC S	40+40	780	230/50	-	-	0,92	1/2	10,9	Forzada Forced	817	Automático Automatic	Digital	R-452



# SERIE EUROPA SERIES

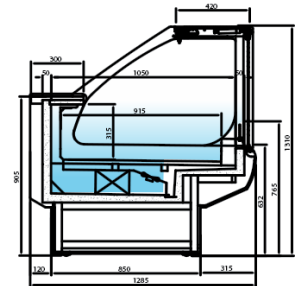

[S]  
SIN RESERVA  
WITHOUT STORAGE

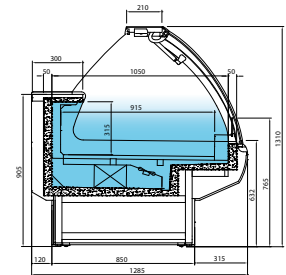

[S]  
SIN RESERVA  
WITHOUT STORAGE

ANGULOS RECTOS RIGHT ANGLES

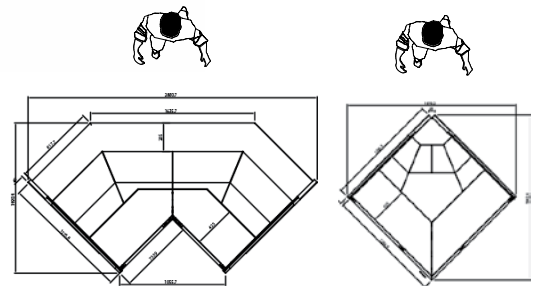

VEU 90 ACR SCP

VEU 90 AAR SCP

**VEU 90 AA S**

**6.171 €**

1326x1285x1310 mm

Temp. 0°C/+6°C  
C. Clima. 4



**VEU 45 AA S**

**3.642 €**

1108x1285x1310 mm

Temp. 0°C/+6°C  
C. Clima. 4



**VEU 90 AC S**

**8.092 €**

1887x1285x1310 mm

Temp. 0°C/+6°C  
C. Clima. 4

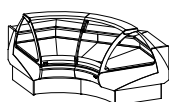

**VEU 45 AC S**

**5.007 €**

1285x1150x1310 mm

Temp. 0°C/+6°C  
C. Clima. 4



**VEU 90 AAR SCP**

**6.558 €**

1285x1150x1310 mm

Temp. 0°C/+6°C  
C. Clima. 4

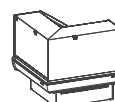

**VEU 90 ACR SCP**

**7.813€**

1887x1285x1310 mm

Temp. 0°C/+6°C  
C. Clima. 4



8.













# VITRINA EXPOSITORA MODULAR FRÍO VENTILADO AUTOSERVICIO

## REFRIGERATED SELF SERVICE MODULAR DISPLAY CASE

Fotos no contractuales / Non contractual pictures



VEU15SCB

MOD.	 Costados Sides [2](mm)	 Potencia Power (W)	 Tensión/Frecuencia Electrical [V/Hz]	 Capacidad Capacity (L)	 Puertas Doors	 Superficie exposición (m <sup>2</sup> )	 Compresor Compressor (HP)	 Consumo Consumption (kWh/24h)	 Evaporación Evaporation	 Potencia frigorífica Cooling capacity (W a -10°C)	 Desescarche Defrost	 Control	 Refrigerante Coolant
VEU 9 SCB	40+40	755	230/50	-	-	0,86	1/2	10,6	Forzada Forced	817	Automático Automatic	Digital	R-452
VEU 12 SCB	40+40	1015	230/50	-	-	1,14	5/8	14,2	Forzada Forced	1096	Automático Automatic	Digital	R-452
VEU 15 SCB	40+40	1070	230/50	-	-	1,43	3/4	15,0	Forzada Forced	1315	Automático Automatic	Digital	R-452
VEU 18 SCB	40+40	1310	230/50	-	-	1,72	1	18,3	Forzada Forced	1506	Automático Automatic	Digital	R-452
VEU 25 SCB	40+40	1585	230/50	-	-	2,29	1+1/6	22,2	Forzada Forced	2009	Automático Automatic	Digital	R-452

# SERIE EUROPA SERIES



VEU15SCB

**Opciones y decoraciones pag. 349**

Options & decorations pag. 349

- Chapa de acero plastificada
- Encimera de trabajo en acero inox AISI 304
- Bancada en acero esmaltado
- Decoracion en DM lacado con iluminación LED
- Plano de exposición en Acero esmaltado
- Sistema de condensación ventilada
- Bandeja evaporativa doble
- Control temperatura final del desescarche
- Desescarche por gas caliente

- Laminated steel plate
- AISI 304 stainless steel worktop
- Enamelled steel base
- DM lacqued decoration with LED lighting
- Enamelled exhibition steel surface
- Forced air refrigeration system
- Stainless steel evaporative doble
- Control of the final defrost temperature
- Hot gaz defrost

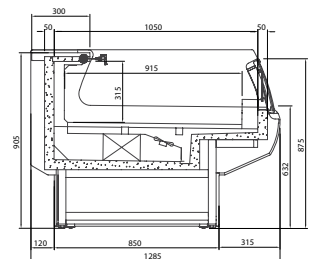

**VEU 9 SCB**

3.241 €

938x1285x905 mm

Temp. 0°C/+6°C  
C. Clima. 3



**VEU 12 SCB**

3.432 €

1250x1285x905 mm

Temp. 0°C/+6°C  
C. Clima. 3



**VEU 15 SCB**

3.825 €

1562x1285x905 mm

Temp. 0°C/+6°C  
C. Clima. 3

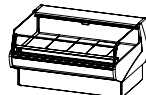

**VEU 18 SCB**

4.134 €

1875x1285x905 mm

Temp. 0°C/+6°C  
C. Clima. 3

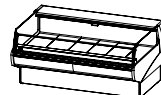

**VEU 25 SCB**

4.841 €

2500x1285x905 mm

Temp. 0°C/+6°C  
C. Clima. 3

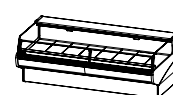

**VEU15SCB**

8.

# MUEBLE CAJA MOSTRADOR

## COUNTER CASE

Fotos no contractuales / Non contractual pictures



VEU 15 M



VEU 9 C

MOD.	Costados Sides (2)(mm)	Potencia Power (W)	Tensión/Frecuencia Electrical (V/Hz)	Superficie exposición (m <sup>2</sup> )
VMD 9 C	40+40	20	230/50	0,71
VMD 12 M	40+40	20	230/50	0,95
VMD 15 M	40+40	20	230/50	1,19

### CARACTERÍSTICAS TÉCNICAS

- Encimera de trabajo y apoya bolsos en acero inoxidable AISI 304
- Bancada en acero esmaltado
- Decoración en DM lacado
- Cuerpo y estantes traseros en madera estratificada blanca

### TECHNICAL FEATURES

- AISI 304 stainless steel worktop
- Base of enameled steel tubo
- DM lacqued decoration
- Structure and rear shelf white laminat wood

### VEU 9 C

1.378 €

938x1285x905 mm

### VEU 12 M

1.465 €

1250x1285x905 mm

### VEU 15 M

1.596 €



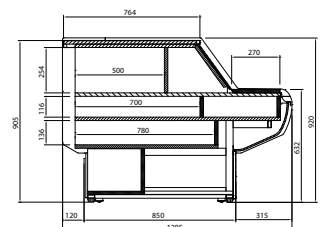









1562x1285x905 mm



# SERIE EUROPA SERIES



Otro color consultar precio  
Other colour consult price

-  RAL 4007  
Violeta  
Violet
-  RAL 2003  
Naranja  
Orange
-  RAL 5015  
Azul  
Blue
-  RAL 3003  
Granate  
Maroon
-  RAL 1018  
Amarillo  
Yellow
-  RAL DESIGN  
2108025  
Celeste  
Sky blue
-  RAL 3020  
Rojo  
Red
-  RAL 9016  
Blanco  
White
-  RAL 6002  
Verde oscuro  
Green dark
-  RAL DESIGN  
3504035  
Rosa  
Pink
-  RAL 1001  
Beige  
Beige
-  RAL DESIGN  
1107060  
Pistacho  
Pistachio

OPCIONES OPTIONS

MOD.	Puertas correderas traseras Rear sliding doors	Doble plano (Sin reserva) Double surface (Without storage)	Plano Inox. Stainless steel surface
VEU 90 AA	[PUEVEU90AACTCP] 250 €	[DPEXVEU90AAS] 33 €	79 €
VEU 90 AA P	[PUEVEU90AACTCP] 250 €		
VEU 45 AA	[PUEVEU45AACTCP] 174 €	[DPEXVEU45AAS] 22 €	53 €
VEU 45 AA P	[PUEVEU45AACTCP] 174 €		
VEU 90 AC	[PUEVEU90ACCTCP] 125 €	[DPEXVEU90ACS] 88 €	106 €
VEU 90 AC P	[PUEVEU90ACCTCP] 125 €		
VEU 45 AC	[PUEVEU45ACCTCP] 87 €	[DPEXVEU45ACS] 44 €	72 €
VEU 45 AC P	[PUEVEU45ACCTCP] 87 €		

MOD.	Puertas correderas traseras Rear sliding doors	Cortinas traseras nocturnas Night curtains	Doble plano (Sin reserva) Double surface (Without storage)	Plano Inox. Stainless steel surface	Cristal calefactado Heated frontal glass
VEU 9 P	[PUEVEU9CTCP] 98 €	[CCNV9] 166 €	[DPEXVEU9S] 45 €	79 €	300 €
VEU 9	[PUEVEU9CT] 98 €				
VEU 12 P	[PUEVEU12CTCP] 145 €	[CCNV12] 220 €	[DPEXVEU12S] 60 €	105 €	311 €
VEU 12	[PUEVEU12CT] 145 €				
VEU 15 P	[PUEVEU15CTCP] 196 €	[CCNV15] 256 €	[DPEXVEU15S] 75 €	131 €	321 €
VEU 15	[PUEVEU15CT] 196 €				
VEU 18 P	[PUEVEU18CTCP] 244 €	[CCNV18] 285 €	[DPEXVEU18S] 90 €	157 €	342 €
VEU 18	[PUEVEU18CT] 244 €				
VEU 25 P	[PUEVEU25CTCP] 297 €	[CCNV25] 332 €	[DPEXVEU25S] 120 €	210 €	621 €
VEU 25	[PUEVEU25CT] 297 €				
VEU 31 P	[PUEVEU31CTCP] 393 €	[CCNV31] 513 €	[DPEXVEU31S] 150 €	262 €	624 €
VEU 31	[PUEVEU31CT] 393 €				
VEU 37 P	[PUEVEU37CTCP] 488 €	[CCNV37] 570 €	[DPEXVEU37S] 180 €	314 €	684 €
VEU 37	[PUEVEU37CT] 488 €				

## MOSTRADOR VITRINA REFRIGERADA



**SZ-100C**



**SZ-100S**



**SZ-100R**

### Modelo **SZ-100**

**NOVEDAD**

- Unidad hermética incorporada bajo la tabla de servicio.
- Evaporador estático.
- Descarche automático.
- Temperatura trabajo: +4° +6°
- Termostato digital.
- Mostrador en acero inox. AISI 304.
- Iluminación uniforme.
- Lados en poliuretano.
- Cristal Curvo/Recto.

Modelo	Largo	Fondo	Alto	Cristal	Iluminación	PVP
<b>SZ-100C</b>	1000	930	660	Curvo	SI	2.145 €
<b>SZ-100R</b>	1000	930	660	Recto	SI	2.060 €
<b>SZ-100S</b>	1000	930	345	Recto	NO	1.830 €
<b>SZ-150C</b>	1500	930	660	Curvo	SI	2.385 €
<b>SZ-150R</b>	1500	930	660	Recto	SI	2.290 €
<b>SZ-150S</b>	1500	930	345	Recto	NO	2.030 €
<b>SOPORTE CARRO PARA VITRINA MODELO 100</b>						200€
<b>SOPORTE CARRO PARA VITRINA MODELO 150</b>						230€