



Catálogo de los
MUEBLES
PARA
EVENTOS
distribuidos en España

Este catálogo agrupa toda la información disponible sobre los [Muebles para Eventos](#) que se distribuyen en España, según la facilitan sus respectivos fabricantes. Esta información incluye productos, modelos, características técnicas y precios.

Los precios indicados en este catálogo son los Precios de Venta Recomendados por cada fabricante, que puede haberlos actualizado, dejándolos obsoletos. Consúltanos el precio actual.

En todo caso, en la tienda online Hostelería10.com mejoramos con grandes descuentos los precios de todos los productos incluidos en este catálogo.

Las marcas de la sección [Muebles para Eventos](#) que forman parte de este catálogo son:

Casfri	Muebles Romero
DBmark	Resol
Ezpeleta	Ripay
Fricosmos	Zown
Hifony	

Sólo una cuidada selección de los mejores productos de este catálogo están incluidos en Hostelería10.com.

Si tienes alguna duda respecto a alguno de estos productos o no encuentras el que buscas, escríbenos a contacto@hosteleria10.com o llámanos al 91 161 03 04.

Estaremos encantados de atenderle.

MESAS HOSTELERÍA

REF. RM. 311

Armazón: Tubo acerado. / Plastificado.

Tablero: Polietileno inyectado.

Color: Gris.

Características:  

Mesa Alta



Ø 80



242 x 76



88 x 88

REF. RM. 311

MEDIDAS EN CM.	EUROS
Ø 80 ALTA	85
Ø 160	196
Ø 180	225
88 x 88	86
153 x 72	87
180 x 74	98
200 x 90	139
210 x 76	118
210 x 86	145
242 x 76	138
240 x 86	159



74



Ø 180

REF. RM. 311 - PLUS

Armazón: Tubo acerado.

Tablero: Plegable. Polietileno inyectado.

Color: Gris.

Características:  

REF. RM. 311 - PLUS

MEDIDAS EN CM.	EUROS
180 x 74	94
210 x 86	140



210 x 86



74

Soportes tijera



Soporte tijera de madera

Cód.	Descripción	U/E	P.V.P./ud.
21	81 cm.	1	49,03
22	96,5 cm.	1	54,45



Soporte tijera cromado

Cód.	Descripción	U/E	P.V.P./ud.
23	74 cm.	1	30,22
24	79 cm.	1	32,43



Soporte tijera cromado negro

Cód.	Descripción	U/E	P.V.P./ud.
23BK	74 cm.	1	26,19
24BK	79 cm.	1	24,05



Soporte plegable de madera

Cód.	Descripción	U/E	P.V.P./ud.
335W	112 cm.	1	72,60
335WBK	112 cm.	1	72,60





Kos

Mesa abatible. Pata aluminio pintado. Reguladores de altura.
 Mesa dobrável. Pé alumínio pintado. Reguladores de altura.
 Folding table. Painted aluminium leg. Adjustable leveling feet.
 Table pliante. Pied aluminium peint. Régulateurs d'hauteur.



tableros / tampos / tops / plateaux



Trebol

Mesa abatible. Pata acero pintado. Reguladores de altura.
 Mesa dobrável. Pé aço pintado. Reguladores de altura.
 Folding table. Painted steel leg. Adjustable leveling feet.
 Table pliante. Pied acier peint. Régulateurs d'hauteur.



tableros / tampos / tops / plateaux

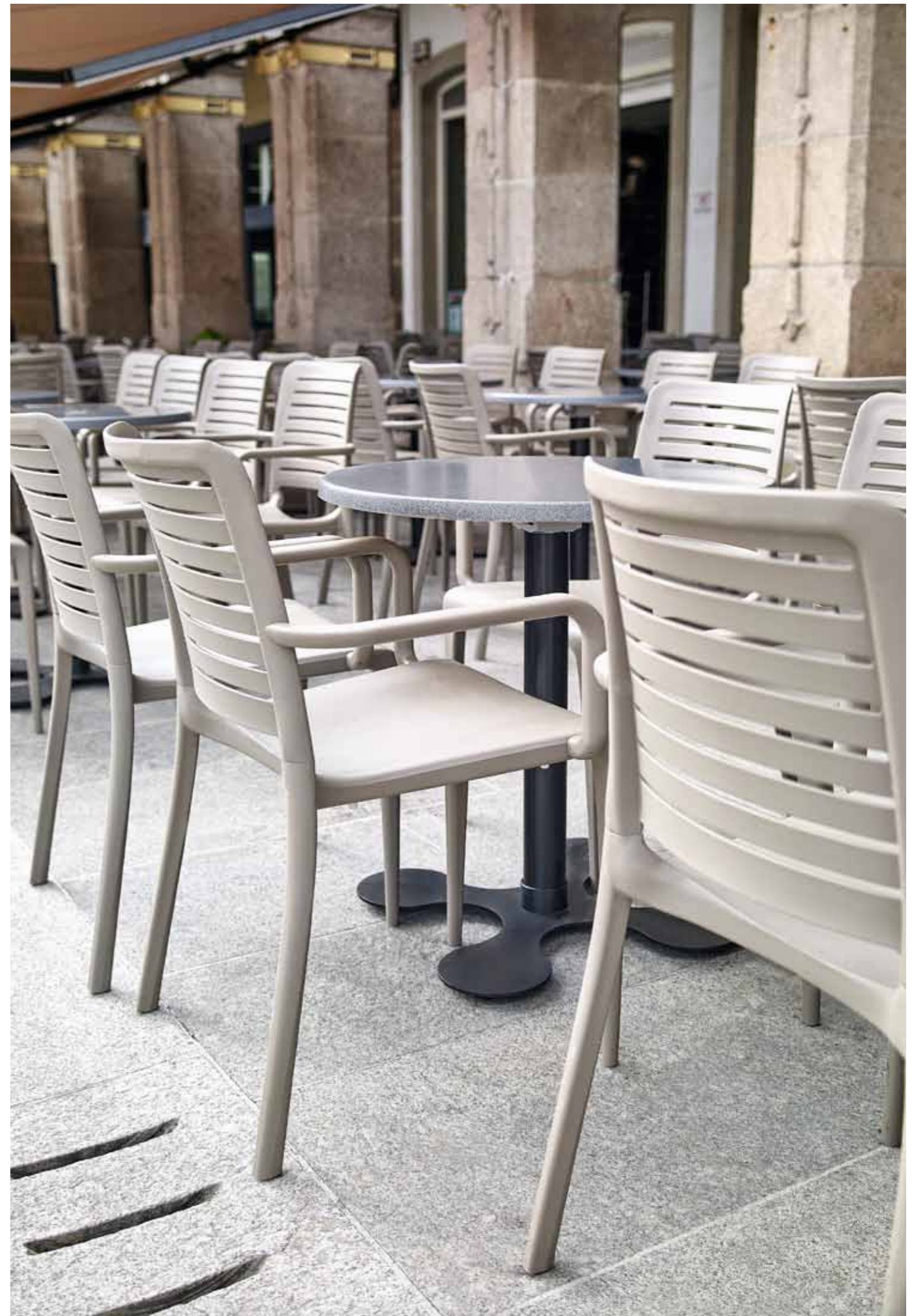



Forest 70x70 MD-FOR00

Mesa Dinning plegable. Madera Balau amarillo.
 Mesa Dinning dobrável. Madeira Balau amarelo.
 Folding Dinning table. Yellow Balau wood.
 Table Dinning pliante. Bois Balau tropical jaune.



Forest 80x80 MD-FOR03

Mesa Dinning plegable. Madera Balau amarillo.
 Mesa Dinning dobrável. Madeira Balau amarelo.
 Folding Dinning table. Yellow Balau wood.
 Table Dinning pliante. Bois Balau tropical jaune.



Forest



Bali 80x80 42BAL00

Mesa apilable. Aluminio. Ratán plano rústico.
 Mesa empilhável. Alumínio. Ratan plano rústico.
 Stackable table. Aluminium. Flat rustic rattan.
 Table empilable. Aluminium. Rattan plat rustique.



tableros / tampos / tops / plateaux

COMPACT

* se sirve montado / entregue montado / supplied assembled / fourni monté.

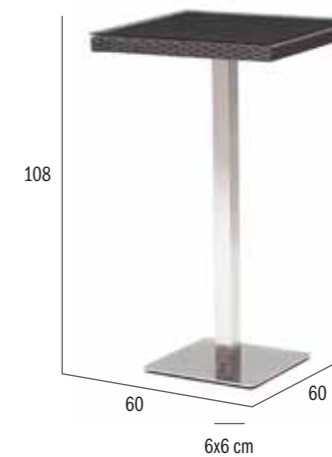

Berlin ML-BER00

Mesa Alta. Aluminio. Ratán 4 vías. Pata central aluminio acabado inox. Con cristal.

Mesa alta. Alumínio. Ratan 4 vías. Pé central alumínio acabamento inox. Com vidro.

High table. 4 in 1 rattan. Aluminium central leg inox finishing. With glass.

Table Haute. Aluminium. Rattan 4 lignes. Pied central aluminium finition inox. Avec verre.



Berlin

Mesas plegables con entrepaño

Centre table with shelve
Table centrale avec rayon



Video



Características:

Fácil transporte.
Fácil almacenaje.
Patas escamoteables hasta alcanzar
1.200x600x63 mm.
Totalmente en acero inoxidable.

Characteristics:

Easy to move.
Easy to store.
Retractable legs to 1200x600x63 mm.
Wholly made of stainless steel.

Caractéristiques:

Facile à déplacer.
Facile à ranger.
Pieds rétractables à 1200x600x63 mm.
Entièrement réalisé en acier inoxydable.

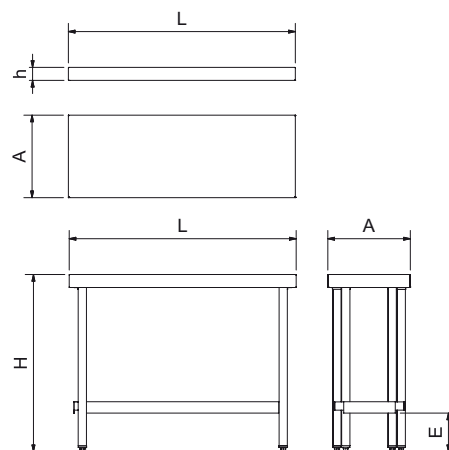

L	A	H	E	h	Kg	Barcode	€
1.100	400	860	187	63	16,0	075804	366,00
1.300	400	860	187	63	18,0	075806	382,00
1.100	500	860	187	63	17,0	075808	391,00
1.300	500	860	187	63	19,0	075810	408,00

Mesa mural satabanco con dos entrepaños

Console table with two shelves
Table console avec deux tablettes-rayons

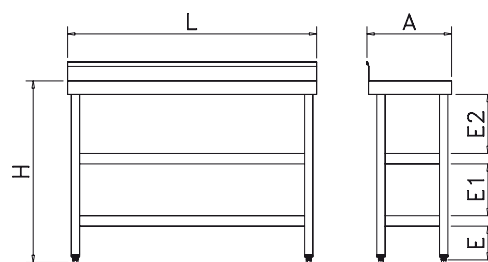

L	A	H	E	E1	E2	Kg	Barcode	€
1.000	400	850	200	243	243	15,95	074408	431,00
1.200	400	850	200	243	243	19,95	074410	456,00

MESA PLEGABLE VERONA

REF^a 137455

**MEDIDAS : 110 (alt) x 70 (Diam.) cm.
ESTRUCTURA DE HIERRO EN COLOR GRIS
TABLERO DE MDF FORRADO EN PVC. TUBOS DE 22 X 0,8 mm
SISTEMA DE SEGURIDAD ANTI-PLEGADO**



RELACIONADO CON:



M311

Armazón: Tubo acerado. /
Plastificado.
Tablero: Polietileno inyectado.
Color: Gris.

Características:



MEDIDAS EN CM	PRECIO
Ø 80 ALTA	68 €
Ø 160	167 €
Ø 180	189 €
88 x 88	65 €
160 x 45	61 €
153 x 72	69 €
180 x 74	81 €
200 x 90	114 €
210 x 76	101 €
210 x 86	111 €
242 x 76	118 €
240 x 86	132 €

Mesa Alta



74



M311 PLUS

Armazón: Tubo acerado
Tablero: Plegable. Polietileno inyectado
Color: Gris

Características:



MEDIDAS EN CM	PRECIO
180x74	74 €
210x86	108 €



74

M950

CARRO PARA TRANSPORTAR MESAS PLEGABLES REDONDAS.

Armazón: Tubo acerado 80 x 40 mm. Plastificado. Ruedas con freno.
Capacidad de transporte: 9 unidades de mesas.



Precio **230 €**

M951

CARRO PARA TRANSPORTAR MESAS PLEGABLES RECTANGULARES.

Armazón: Tubo acerado 80 x 40 mm. Plastificado. Ruedas con freno.

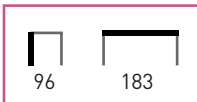

Precio **230 €**

M312

Armazón: Tubo acerado.
Tablero: Melamínico color crema. /Canteado en P.V.C.

Características:



PRECIOS	TABLERO MELAMÍNICO CANTO PVC	
	PLASTIFICADO STANDARD*	CROMADO
Ø 150	131 €	156 €
Ø 160	141 €	166 €
Ø 180	154 €	179 €
200 x 45	114 €	136 €
200 x 80	126 €	155 €
240 x 80	149 €	178 €

* Plastificado standard blanco o negro.
Colores especiales incremento 5 €

M311

Armazón: Tubo acerado. /
Plastificado.
Tablero: Polietileno inyectado.
Color: Gris.

Características:



MEDIDAS EN CM	PRECIO
Ø 80 ALTA	68 €
Ø 160	167 €
Ø 180	189 €
88 x 88	65 €
160 x 45	61 €
153 x 72	69 €
180 x 74	81 €
200 x 90	114 €
210 x 76	101 €
210 x 86	111 €
242 x 76	118 €
240 x 86	132 €

Mesa Alta



M311 PLUS

Armazón: Tubo acerado
Tablero: Plegable. Polietileno inyectado
Color: Gris

Características:



MEDIDAS EN CM	PRECIO
180x74	74 €
210x86	108 €



M950

CARRO PARA TRANSPORTAR MESAS PLEGABLES REDONDAS.

Armazón: Tubo acerado 80 x 40 mm. Plastificado. Ruedas con freno.
Capacidad de transporte: 9 unidades de mesas.

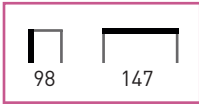

Precio **230 €**

M951

CARRO PARA TRANSPORTAR MESAS PLEGABLES RECTANGULARES.

Armazón: Tubo acerado 80 x 40 mm. Plastificado. Ruedas con freno.

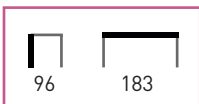

Precio **230 €**

M312

Armazón: Tubo acerado.
Tablero: Melamínico color crema. /Canteado en P.V.C.

Características:



PRECIOS	TABLERO MELAMÍNICO CANTO PVC	
	PLASTIFICADO STANDARD*	CROMADO
Ø 150	131 €	156 €
Ø 160	141 €	166 €
Ø 180	154 €	179 €
200 x 45	114 €	136 €
200 x 80	126 €	155 €
240 x 80	149 €	178 €

* Plastificado standard blanco o negro.
Colores especiales incremento 5 €

Resol es el único fabricante del mundo que ofrece

- **Un sistema de mesas conectables que permite cualquier composición, PATENTE U 200800685 (9)**
- **Dos versiones: ancho 75 / ancho 91**
- **Resistencia probada para uso contract**
- **La gama existente más amplia de mesas, carros, sillas y fundas para catering y convenciones**

Resol is the only manufacturer in the world who offers

- **A system of connectable tables that allow any composition, PATENT U 200800685 (9)**
- **Two versions: width 75 / width 91**
- **Proven resistance for catering and hotel use**
- **The most extensive existing range of tables, trolleys, chairs and covers for catering and conventions**

Resol est le seul fabriquant du monde qui propose :

- *Un système de tables modulables qui permet quelconque composition, BREVET U 200800685 (9)*
- *Deux versions: largeur 75 / largeur 91*
- *Résistance testée pour un usage dans l'hôtellerie*
- *La plus grande gamme existante de tables, chariots, chaises et housses pour la restauration et les conventions.*



* Según condiciones legales y comerciales establecidas en <http://www.resol.es/es/garantias.aspx>. Solamente para los modelos determinados en estas condiciones de garantía.

* According to legal and commercial conditions set forth in <http://www.resol.es/es/garantias.aspx>. Only for the models specified in these warranty conditions.

* Selon les conditions juridiques et commerciales énoncées sur <http://www.resol.es/es/garantias.aspx>. Seulement pour les modèles indiqués avec ces conditions de garantie.



rossini



mesa

table

table

Ø 122 x H 74 cm
Ø 48.03 x H 29.13 in



Gris | Grey | Gris

315 kg / 693 lb x 6



Mesa plegable con estructura de acero pintado. Sobre de polietileno de alta densidad, en color gris claro. Grosor del sobre: 45 mm. Sobre estanco de una sola pieza sin uniones. Peso neto: 12 kg. Travesaños ergonómicos.

Folding painted steel frame table. Table top of high density polyethylene in light grey. Table top thickness: 45 mm. Leakproof table top in one sole piece without joints. Net weight: 12 kg (26.45 lb). Ergonomic crossbeams.

Table pliable avec structure en acier peint et revêtement en polyéthylène de haute densité de couleur gris clair. Grosseur du plateau de 45 mm. Plateau étanche d'une seule pièce sans raccords. Poids net: 12 kg. Traverses ergonomiques.

Units STD	Packaging Dimensions (cm)	m3/ pack	NW Unit (kg)	Units Container 20'	Units Container 40'	Units Container HC	Units Traylor (70m3)	Units Truck 100m3
1	123x123x4,4	0,09	12	253	505	566	609	871
34	125x125x215	3,36	12	136	306	306	340	408

verdi



mesa

table

table

Ø 152 x H 74 cm
Ø 59.84 x H 29.13 in



Gris | Grey | Gris

315 kg / 693 lb x 7



Mesa plegable con estructura de acero pintado y sobre de polietileno de alta densidad, en color gris claro. Grosor sobre 45 mm. Sobre estanco de una sola pieza sin uniones. Peso neto 19 kg. Travesaños ergonómicos.

Table pliante avec structure d'acier peint et plateau en polyéthylène de haute densité couleur gris clair. Grosseur plateau 45 mm. Plateau d'une seule pièce. Poids net 19 kg. Traverses ergonomiques.

Table pliante avec structure d'acier peint et plateau en polyéthylène de haute densité couleur gris clair. Grosseur plateau 45 mm. Plateau d'une seule pièce. Poids net 19 kg. Traverses ergonomiques.

Units STD	Packaging Dimensions (cm)	m3/ pack	NW Unit (kg)	Units Container 20'	Units Container 40'	Units Container HC	Units Traylor (70m3)	Units Truck 100m3
1	154x154x5,5	0,14	27	154	320	360	370	529
31	156x156x216	5,25	27	93	217	217	248	279

W: ancho / width / largeur
L: largo / length / longueur
H: altura / height / hauteur

HOSTELERÍA10.com
Las mejores marcas, ofertas y precios



krauss



mesa

table

table

∅ 160 x H 74 cm

∅ 62.99 x H 29.13 in



Gris | Grey | Gris

315 kg / 693 lb

x 8



Mesa plegable con estructura de acero pintado y sobre de polietileno de alta densidad, en color gris claro. Grosor sobre 50 mm. Sobre estanco de una sola pieza sin uniones. Peso neto 25 kg. Travesaños ergonómicos.

Folding table with powder-coated steel frame and high density polyethylene table top. Table top 50 mm thick. Single piece table top with no joints. Net weight 25 kg (55 lb). Ergonomic crossbeams. Available in light grey.

Table pliante avec structure d'acier peint et plateau en polyéthylène de haute densité couleur gris clair. Grosseur plateau 50 mm. Plateau d'une seule pièce. Poids net 25 kg. Traverses ergonomiques.

Units STD	Packaging Dimensions (cm)	m ³ / pack	NW Unit (kg)	Units Container 20'	Units Container 40'	Units Container HC	Units Traylor (70m3)	Units Truck 100m3
1	161x161x6	0,16	25	135	270	333	344	500
32	168x168x235	6,63	25	96	224	224	256	256

beethoven



mesa

table

table

∅ 180 x H 74 cm

∅ 70.87 x H 29.13 in



Gris | Grey | Gris

350 kg / 770 lb

x 9



Mesa plegable con estructura de acero pintado y sobre de polietileno de alta densidad, en color gris claro. Grosor sobre 50 mm. Sobre estanco de una sola pieza sin uniones. Peso neto 29 kg. Travesaños ergonómicos.

Folding table with powder-coated steel frame and high density polyethylene table top. Table top 50 mm thick. Single piece table top with no joints. Net weight 29 kg (63.93 lb). Ergonomic crossbeams. Available in light grey.

Table pliante avec structure d'acier peint et plateau en polyéthylène de haute densité couleur gris clair. Grosseur plateau 50 mm. Plateau d'une seule pièce. Poids net 29 kg. Traverses ergonomiques.

Units STD	Packaging Dimensions (cm)	m ³ / pack	NW Unit (kg)	Units Container 20'	Units Container 40'	Units Container HC	Units Traylor (70m3)	Units Truck 100m3
1	182x182x6,5	0,22	29	105	210	235	253	362
30	182x182x235	7,78	29	87	174	174	240	270

W: ancho / width / largeur

L: largo / length / longueur

H: altura / height / hauteur

HOSTELERÍA10.com
Las mejores marcas, ofertas y precios

mozart



mesa

table

table

∅ 200 x H 74 cm

∅ 78.74 x H 29.13 in



Gris | Grey | Gris

350 kg / 770 lb

x 10



Mesa plegable con estructura de acero pintado y sobre de polietileno de alta densidad, en color gris claro. Grosor sobre 50 mm. Sobre estanco de una sola pieza sin uniones. Peso neto 33 kg. Travesaños ergonómicos.

Folding table with powder-coated steel frame and high density polyethylene table top. Table top 50 mm thick. Single piece table top with no joints. Net weight 33 kg (72.60 lb). Ergonomic crossbeams. Available in light grey.

Table pliante avec structure d'acier peint et plateau en polyéthylène de haute densité couleur gris clair. Grosseur plateau 50 mm. Plateau d'une seule pièce. Poids net 33 kg. Traverses ergonomiques.

Units STD	Packaging Dimensions (cm)	m3/ pack	NW Unit (kg)	Units Container 20'	Units Container 40'	Units Container HC	Units Traylor (70m3)	Units Truck 100m3
1	202x202x6,5	0,26	33	98	175	200	234	258
30	202x202x235	9.5	33	60	150	150	180	180

RESOL Contract

yago



mesa

table

table

W 87 x L 87 x H 74 cm

W 34.25 x L 34.25 x H 29.13 in



Gris | Grey | Gris

300 kg / 660 lb

x 4



Mesa plegable con estructura de acero pintado y sobre de polietileno de alta densidad, en color gris claro. Grosor del sobre: 45 mm. Sobre estanco de una sola pieza sin uniones. Peso neto: 9 kg. Travesaños ergonómicos.

Folding table with painted steel frame and high density polyethylene table top in light grey. Table top thickness: 45 mm. Leakproof table top in one sole piece without joints. Net weight: 9 kg (19.84 lb). Ergonomic crossbeams.

Table pliable avec structure en acier peint et revêtement en polyéthylène de haute densité de couleur gris clair. Grosseur du plateau de 45 mm. Plateau étanche d'une seule pièce sans raccords. Poids net: 9 kg. Traverses ergonomiques.

Units STD	Packaging Dimensions (cm)	m3/ pack	NW Unit (kg)	Units Container 20'	Units Container 40'	Units Container HC	Units Traylor (70m3)	Units Truck 100m3
1	89x89x5,40	0,05	9	502	1.004	1.125	1.211	1.731
36	91x91x226	1,87	9	432	864	864	1.008	1.152

W: ancho / width / largeur

L: largo / length / longueur

H: altura / height / hauteur

HOSTELERÍA10.com
Las mejores marcas, ofertas y precios

strauss



mesa

table

table

W 61 x L 122 x H 74 cm

W 24.02 x L 48.03 x H 29.13 in



Gris | Grey | Gris

270 kg / 594 lb



Mesa plegable con estructura de acero pintado y sobre de polietileno de alta densidad, en color gris claro. Grosor sobre 45 mm. Sobre estanco de una sola pieza sin uniones. Peso neto 9 kg. Travesaños ergonómicos.

Folding table with powder-coated steel frame and high density polyethylene table top. Table top thickness: 45 mm. Single piece table top with no joints. Net weight 9 kg (19,84 lb). Ergonomic crossbeams. Available in light grey.

Table pliante avec structure d'acier peint et plateau en polyéthylène de haute densité couleur gris clair. Grosseur plateau 45 mm. Plateau d'une seule pièce. Poids net 9 kg. Traverses ergonomiques.

Units STD	Packaging Dimensions (cm)	m3/ pack	NW Unit (kg)	Units Container 20'	Units Container 40'	Units Container HC	Units Traylor (70m3)	Units Truck 100m3
1	123x62x5,40	0,05	9	571	1.142	1.279	1.378	1.968
36	125x64x226	1,81	9	432	972	972	1.080	828

mahler



mesa

table

table

W 75,5 x L 152 x H 74 cm

W 29.72 x L 59.84 x H 29.13 in



Gris | Grey | Gris

270 kg / 594 lb x 4



Mesa plegable con estructura de acero pintado y sobre de polietileno de alta densidad, en color gris claro. Grosor del sobre: 45 mm. Sobre estanco de una sola pieza sin uniones. Peso neto: 12 kg. Travesaños ergonómicos. La unión de 2 mesas Mahler permite una composición de 150 x 150 cm. Sistema de unión longitudinal de mesas.

Folding table with painted steel frame and high density polyethylene table top in light grey. Table top thickness: 45 mm. Leakproof table top in one sole piece without joints. Net weight: 12 kg (26.45 lb). Ergonomic crossbeams. The joining of 2 Mahler tables permits a composition of 150 x 150 cm. Longitudinal joining system of the tables.

Table pliable avec structure en acier peint et revêtement en polyéthylène de haute densité de couleur gris clair. Grosseur du plateau de 45 mm. Plateau étanche d'une seule pièce sans raccords. Poids net: 12 kg. Traverses ergonomiques. Le raccord de 2 Mahlers permet une composition de 150 x 150 cm. Système de raccord longitudinal des tables.

Units STD	Packaging Dimensions (cm)	m3/ pack	NW Unit (kg)	Units Container 20'	Units Container 40'	Units Container HC	Units Traylor (70m3)	Units Truck 100m3
1	153x77x5,40	0,07	12	375	750	840	905	1.293
36	156x78x226	2,75	12	252	540	540	864	972

W: ancho / width / largeur

L: largo / length / longueur

H: altura / height / hauteur

chopin



mesa

table

table

W 75,5 x L 183 x H 74 cm

W 29.72 x L 72.05 x H 29.13 in



Gris | Grey | Gris

Marrón | Brown | Brun

315 kg / 693 lb x 6



Mesa plegable con estructura de acero pintado y sobre de polietileno de alta densidad, en color gris claro. Grosor sobre 45 mm. Sobre estanco de una sola pieza sin uniones. Peso neto 14 kg. Travesaños ergonómicos. Sistema de unión de mesas.

Folding table with powder-coated steel frame and high density polyethylene table top. Table top 45 mm thick. Single piece table top with no joints. Net weight 14 kg (30.86 lb). Ergonomic crossbeams. Available in light grey. Table joining system.

Table pliante avec structure d'acier peint et plateau en polyéthylène de haute densité couleur gris clair. Grosseur plateau 45 mm. Plateau d'une seule pièce. Poids net 14 kg. Traverses ergonomiques. Système d'union des tables.

Units STD	Packaging Dimensions (cm)	m3/ pack	NW Unit (kg)	Units Container 20'	Units Container 40'	Units Container HC	Units Traylor (70m3)	Units Truck 100m3
1	184x77x5,40	0,08	14	333	690	773	832	1.189
36	187x80x226	3,38	14	252	540	540	756	684

smart



mesa

table

table

W 75,5 x L 182 x H 74 cm

W 29.72 x L 71.65 x H 29.13 in



Gris | Grey | Gris

315 kg / 693 lb x 6



Mesa plegable con estructura de acero pintado y sobre de polietileno de alta densidad, en color blanco. Sobre de 45 mm de grosor con asa para fácil transporte. Tablero articulado para un óptimo almacenaje. Peso neto: 14 kg. Travesaños ergonómicos.

Folding table with painted steel structure and high density polyethylene table top in white. Table top with a 45 mm thickness and easy to carry handle. Articulated table top board for optimum storage. Net weight: 14 kg (30.86 lb). Ergonomic crossbeams.

Table pliable avec structure en acier peint et plateau en polyéthylène de haute densité de couleur blanche. Plateau de 45 mm. de grosseur avec anse pour faciliter le transport. Plateau articulé pour permettre un rangement optimum. Poids net: 14 kg.

Units STD	Packaging Dimensions (cm)	m3/ pack	NW Unit (kg)	Units Container 20'	Units Container 40'	Units Container HC	Units Traylor (70m3)	Units Truck 100m3
1	94x76x9,5	0,07	14	342	684	766	825	1.179
19	215x96x76	1,53	14	342	684	684	798	855

W: ancho / width / largeur

L: largo / length / longueur

H: altura / height / hauteur

HOSTELERÍA10.com
Las mejores marcas, ofertas y precios

smart



banco

bench

banc

W 28 x L 183 x H 42,5 cm

W 11.02 x L 72.05 x H 16.73 in



Gris | Grey | Gris

400 kg / 880 lb x 3



Banco plegable con estructura de acero pintado y asiento de polietileno de alta densidad, en color blanco. Asiento de 50 mm de grosor con asa para fácil transporte. Asiento articulado para un óptimo almacenamiento. Peso neto: 7,7 kg.

Folding bench with painted steel structure and high density polyethylene seat in white. Seat with a 50 mm thickness and easy to carry handle. Articulated seat for optimum storage. Net weight: 7,7 kg (16.97 lb).

Banc pliable avec structure en acier peint et siège en polyéthylène de haute densité de couleur blanche. Siège de 50 mm. de grosseur avec anse pour faciliter le transport. Siège articulé pour un rangement optimum. Poids net: 7,7 kg.

Units STD	Packaging Dimensions (cm)	m3/ pack	NW Unit (kg)	Units Container 20'	Units Container 40'	Units Container HC	Units Traylor (70m3)	Units Truck 100m3
1	92,50x28,50x9	0,03	7.7	840	1.680	1.932	2.464	3.200
70	92x113x217	2,25	7.7	840	1.820	1.820	1.960	2.240

vivaldi



mesa

table

table

W 90 x L 200 x H 74 cm

W 35.43 x L 78.74 x H 29.13 in



Gris | Grey | Gris

350 kg / 770 lb x 6+2



Mesa plegable con estructura de acero pintado y sobre de polietileno de alta densidad, en color gris claro. Grosor sobre 45 mm. Sobre estanco de una sola pieza sin uniones. Peso neto 18,5 kg. Travesaños ergonómicos. Sistema de unión de mesas.

Folding table with powder-coated steel frame and high density polyethylene table top. Tabletop 45 mm thick. Net weight 18,5 kg (40.78 lb). Single piece table top with no joints. Ergonomic crossbeams. Table joining system. Available in light grey.

Table pliante avec structure d'acier peint et plateau en polyéthylène de haute densité couleur gris clair. Grosseur plateau 45 mm. Plateau d'une seule pièce. Poids net 18,5 kg. Traverses ergonomiques. Système d'union des tables.

Units STD	Packaging Dimensions (cm)	m3/ pack	NW Unit (kg)	Units Container 20'	Units Container 40'	Units Container HC	Units Traylor (70m3)	Units Truck 100m3
1	202x92,50x5,40	0,11	18,5	256	512	573	617	882
36	202x94x226	4,29	18,5	216	432	432	504	540

W: ancho / width / largeur
L: largo / length / longueur
H: altura / height / hauteur

wagner



mesa

table

table

W 75,5 x L 243 x H 74 cm

W 29.72 x L 95.67 x H 29.13 in



Gris I Grey I Gris

350 kg / 770 lb x 8



Mesa plegable con estructura de acero pintado y sobre de polietileno de alta densidad, en colorgris claro. Grosor del sobre: 50 mm. Sobre estanco de una sola pieza sin uniones. Peso neto: 20kg. Travesaños ergonómicos.

Folding table with painted steel frame and high density polyethylene table top in light grey. Table toptickness: 50 mm. Leakproof table top in one sole piece without joints. Net weight: 20 kg (44.09 lb).Ergonomic crossbeams.

Table pliante avec structure en acier peint et plateau en polyéthylène de haute densité decouleur gris clair. Grosseur plateau 50 mm. Plateau étanche d'une seule pièce sans raccords.Poids net: 20 kg. Traverses ergonomiques.

Units STD	Packaging Dimensions (cm)	m3/ pack	NW Unit (kg)	Units Container 20'	Units Container 40'	Units Container HC	Units Trayler (70m3)	Units Truck 100m3
1	244x77,50x5,40	0,11	20	184	368	412	444	634
31	197x80x242	3,81	20	124	248	248	465	558

bach



mesa

table

table

W 45,5 x L 183 x H 74 cm

W 17.91 x L 72.05 x H 29.13 in



Gris I Grey I Gris

315 kg / 693 lb x 3



Mesa plegable con estructura de acero pintado y sobre de polietileno de alta densidad, en color gris claro. Grosor sobre 45 mm. Sobre estanco de una sola pieza sin uniones. Peso neto 10 kg. Travesaños ergonómicos.

Folding table with powder-coated steel frame and high density polyethylene table top. Table top 45 mm thick. Single piece table top with no joints. Net weight 10 kg. (22.05 lb). Ergonomic crossbeams.

Table pliante avec structure d'acier peint et plateau en polyéthylène de haute densité couleur gris clair. Grosseur plateau 45 mm. Plateau d'une seule pièce. Poids net 10 kg. Traverses ergonomiques.

Units STD	Packaging Dimensions (cm)	m3/ pack	NW Unit (kg)	Units Container 20'	Units Container 40'	Units Container HC	Units Trayler (70m3)	Units Truck 100m3
1	184,50x47x5,40	0,06	10	457	914	1.024	1.103	1.575
62	120x120x235	3.38	10	372	744	744	868	1.240

W: ancho / width / largeur

L: largo / length / longueur

H: altura / height / hauteur

HOSTELERÍA10.com
Las mejores marcas, ofertas y precios

hamlet



mesa

table

table

Ø 80 x H 74cm

Ø 31.50 x H 29.13 in



Gris | Grey | Gris

170 kg / 374 lb



Mesa plegable con estructura de acero pintado. Sobre de polietileno de alta densidad. Color gris claro. Grosor del sobre: 45 mm. Sobre de estanco de una sola pieza sin uniones. Peso neto: 7,5 kg.

Folding painted steel frame table. Table top of high density polyethylene. Light grey colour. Table top thickness: 45 mm (1.8 in). Leak proof table top in one sole piece without joints. Net weight: 7,5 kg (34.25 lb).

Table pliante avec structure en acier peint et revêtement en polyéthylène de haute densité. Couleur gris clair. Grosseur du plateau: 45 mm. Plateau étanche d'une seule pièce sans raccords. Poids net: 7,5 kg.

Units STD	Packaging Dimensions (cm)	m3/ pack	NW Unit (kg)	Units Container 20'	Units Container 40'	Units Container HC	Units Traylor (70m3)	Units Truck 100m3
1	105x82x5,40	0,05	7.5	423	846	948	1.021	1.458
31	164x112x117	2,15	7.5	-	912	992	-	-

hamlet 110



mesa

table

table

Ø 80 x H 110 cm

Ø 31.50 x H 43.31 in



Gris | Grey | Gris

170 kg / 374 lb



Mesa plegable con estructura de acero pintado y sobre de polietileno de alta densidad. Color gris claro. Grosor del sobre: 45 mm. Sobre de estanco de una sola pieza sin uniones. Peso neto: 8 kg.

Folding table with painted steel frame and high density polyethylene table top. Light grey colour. Table top thickness: 45 mm (1.8 in). Leak proof table top in one sole piece without joints. Net weight: 8 kg (17.95 lb).

Table pliante avec structure en acier peint et revêtement en polyéthylène de haute densité. Couleur gris clair. Grosseur du plateau de 45 mm. Plateau étanche d'une seule pièce sans raccords. Poids net : 8 kg.

Units STD	Packaging Dimensions (cm)	m3/ pack	NW Unit (kg)	Units Container 20'	Units Container 40'	Units Container HC	Units Traylor (70m3)	Units Truck 100m3
1	137x82x5,4	0,05	8	423	846	948	1.021	1.458
31	142x85x197	2,38	8	430	860	860	558	620

W: ancho / width / largeur

L: largo / length / longueur

H: altura / height / hauteur

Sistema de unión de mesas

Table joining system

Système d'union de tables

Chopin + Chopin ((183+183)x75)

Vivaldi + Vivaldi (198+198)x91)

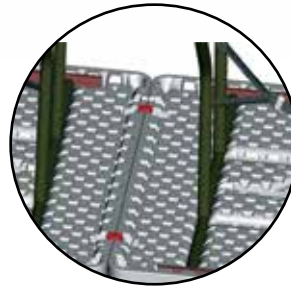
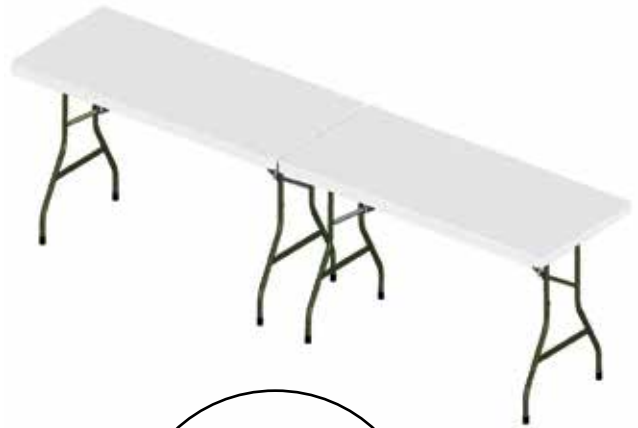

Sistema de mesas conectables que permite cualquier composición - PATENTE U 200800685 (9).

A system of conectable tables that allow any composition, PATENT U 200800685 (9).

Un système de tables modulables qui permet quelconque composition, BREVET U 200a800685 (9).

Mahler + Mahler ((75+75)x150)

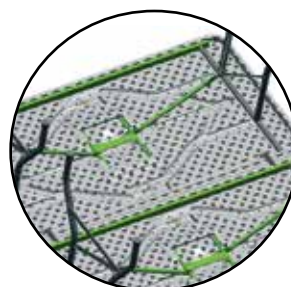

RITA



Ø 50 x H 49 cm
Ø 19.69 x H 19.29 in

■ Ref. 03715

■ Ref. 03716

■ Ref. 03717

■ Ref. 03718

■ Ref. 03719

Mesa monobloc para uso interior y exterior. Inyectada en polipropileno. Apilable. Protección UV. Peso neto 1,85 kg. Box palet (15 unidades): 3 verde lima / 3 azul cielo / 3 rosa / 3 naranja / 3 roja.

Monobloc table for indoor and outdoor use. Injected with polypropylene. Stackable. UV protection. Net weight 1,85 kg (4.08 lb). Box pallet (15 units): 3 lime green / 3 light blue / 3 pink / 3 orange / 3 red.

Table monobloc d'intérieur et extérieur. Injectée en polypropylène. Empilable. Protection UV. Poids net 1,85 kg. Box palette (15 unités): 3 vert lime / 3 bleu ciel / 3 rose / 3 orange / 3 rouge.

Units STD	Packaging Dimensions (cm)	m3/ pack	NW Unit (kg)	Units Container 20'	Units Container 40'	Units Container HC	Units Traylor (70m3)	Units Truck 100m3
4	60x60x63	0,23	1,82	324	720	960	1.400	1.600
80	80x120x213	2,04	1,82	1.080	2.160	2.560	2.640	3.040
15	80x60x120	0,56	1,82	750	1.500	1.755	1.980	2.280

EASY TABLE 75



W 49,5 x L 75,5 x H 73 cm
W 19.49 x L 29.72 x H 28.74 in

■ Ref. 66471

Mesa con estructura plegable de acero pintado por pulverización al horno en color negro, y sobre de polietileno de alta densidad en color blanco. Grosor del sobre 45 mm. Sobre estanco de una sola pieza sin uniones. Travesaños ergonómicos. Peso neto 4 kg.

Foldable table made in high-density polyethylene with black powder-coated steel structure. Table top thickness 45 mm. Leakproof table top in one sole piece without joints. Ergonomic crossbeams. Net weight 4 kg (8.82 lb).

Table pliante de polyéthylène d'haute densité en couleur blanc et structure en acier peint par pulvérisation au four en couleur noir. Grosseur du plateau de 45 mm. Traverses ergonomiques. Poids net 4 kg.

Units STD	Packaging Dimensions (cm)	m3/ pack	NW Unit (kg)	Units Container 20'	Units Container 40'	Units Container HC	Units Traylor (70m3)	Units Truck 100m3
1	51,5x8x89	0,04	4	-	1.492	-	1.800	-
30	100x120x235	2,82	4	-	-	660	780	900

EASY TABLE 122



W 60 x L 122 x H 74 cm
W 23.62 x L 48.03 x H 29.13 in

■ Ref. 66506

Mesa con estructura plegable de acero pintado por pulverización al horno en color negro, y sobre de polietileno de alta densidad en color blanco. Grosor del sobre 45 mm. Sobre estanco de una sola pieza sin uniones. Ajustable en altura (52/74 cm). Travesaños ergonómicos. Peso neto 9 kg.

Foldable table made in high-density polyethylene with black powder-coated steel structure. Table top thickness 45 mm. Height adjustable (52/74 cm - 20.47/29.13 in). Leakproof table top in one sole piece without joints. Ergonomic crossbeams. Net weight 9 kg (19.84 lb).

Table pliante de polyéthylène d'haute densité en couleur blanc et structure en acier peint par pulvérisation au four en couleur noir. Grosseur du plateau de 45 mm. Hauteur ajustable (52/74 cm). Traverses ergonomiques. Poids net 9 kg.

Units STD	Packaging Dimensions (cm)	m3/ pack	NW Unit (kg)	Units Container 20'	Units Container 40'	Units Container HC	Units Traylor (70m3)	Units Truck 100m3
1	62x10x65	0,04	9	-	1.650	-	1.990	-
30	100x120x235	2,82	9	-	-	660	780	900

EASY TABLE 183



W 76 x L 183 x H 74 cm
W 29.92 x L 72.05 x H 29.13 in

Ref. 66468

Mesa con estructura plegable de acero pintado por pulverización al horno en color negro, y sobre de polietileno de alta densidad en color blanco. Grosor del sobre 45 mm. Sobre estanco de una sola pieza sin uniones. Travesaños ergonómicos. Peso neto 13,8 kg.

Foldable table made in high-density polyethylene with black powder-coated steel structure. Table top thickness 45 mm. Leakproof table top in one sole piece without joints. Ergonomic crossbeams. Net weight 13,8 kg (30.42 lb).

Table pliante de polyéthylène d'haute densité en couleur blanc et structure en acier peint par pulvérisation au four en couleur noir. Grosseur du plateau de 45 mm. Traverses ergonomiques. Poids net 13,8 kg.

Units STD	Packaging Dimensions (cm)	m3/ pack	NW Unit (kg)	Units Container 20'	Units Container 40'	Units Container HC	Units Traylor (70m3)	Units Truck 100m3
1	76x8,5x93,5	0,06	13,8	-	860	-	1.036	-
30	112x97x205	2,22	13,8	-	-	660	780	900

EASY RATTAN 180



W 75 x L 180 x H 72 cm
W 29.53 x L 70.87 x H 28.35 in

Ref. 59576 Ref. 59577

Mesa con estructura plegable de acero pintado por pulverización al horno, y tablero de polietileno de alta densidad disponible en blanco y chocolate con acabado ratán. Peso neto 12,5 kg.

Foldable table with powder-coated steel structure. High density polyethylene table top available in white and chocolate with rattan finishing. Net weight 12,5 kg (27.58 lb).

Table pliante avec structure en acier peint par pulvérisation au four et plateau en polyéthylène de haute densité disponible en blanc et chocolat avec finition rattan. Poids net 12,5 kg.

Units STD	Packaging Dimensions (cm)	m3/ pack	NW Unit (kg)	Units Container 20'	Units Container 40'	Units Container HC	Units Traylor (70m3)	Units Truck 100m3
1	76x8,5x93,5	0,06	12,5	-	860	-	1.036	-
30	112x97x205	2,22	12,5	-	-	660	780	900

EASY TABLE 243



W 76 x L 243 x H 74 cm
W 29.92 x L 95.67 x H 29.13 in

Ref. 66469

Mesa con estructura plegable de acero pintado por pulverización al horno en color negro, y sobre de polietileno de alta densidad en color blanco. Grosor del sobre 45 mm. Sobre estanco de una sola pieza sin uniones. Travesaños ergonómicos. Peso neto 19 kg.

Foldable table made in high-density polyethylene with black powder-coated steel structure. Table top thickness 45 mm. Leakproof table top in one sole piece without joints. Ergonomic crossbeams. Net weight 19 kg (41.89 lb).

Table pliante de polyéthylène d'haute densité en couleur blanc et structure en acier peint par pulvérisation au four en couleur noir. Grosseur du plateau de 45 mm. Traverses ergonomiques. Poids net 19 kg.

Units STD	Packaging Dimensions (cm)	m3/ pack	NW Unit (kg)	Units Container 20'	Units Container 40'	Units Container HC	Units Traylor (70m3)	Units Truck 100m3
1	76x9,2x124,5	0,08	19	-	520	-	626	-
30	156x112x213	3,72	19	-	520	-	626	-

EASY VERSA TABLE



W 65 x L 126,5 x H 94,5 cm
 W 25.59 x L 49.80 x H 37.20 in

Ref. 66473

Mesa con estructura plegable de acero pintado por pulverización al horno en color negro, y sobre de polietileno de alta densidad en color blanco. Grosor del sobre 45 mm. Sobre estanco de una sola pieza sin uniones. Travesaños ergonómicos. Peso neto 15 kg.

Foldable table made in high-density polyethylene with black powder-coated steel structure. Table top thickness 45 mm. Leakproof table top in one sole piece without joints. Ergonomic crossbeams. Net weight 15 kg (33.07 lb).

Table pliante de polyéthylène d'haute densité en couleur blanc et structure en acier peint par pulvérisation au four en couleur noir. Grosseur du plateau de 45 mm. Traverses ergonomiques. Poids net 15 kg.

Units STD	Packaging Dimensions (cm)	m3/ pack	NW Unit (kg)	Units Container 20'	Units Container 40'	Units Container HC	Units Traylor (70m3)	Units Truck 100m3
1	67x11x129	0,10	15	-	680	-	820	-
30	120x100x235	2,82	15	-	-	660	780	900

EASY SIT



W 25 x L 183 x H 43 cm
 W 9.84 x L 72.05 x H 16.93 in

Ref. 66470

Banco plegable de polietileno de alta densidad de color blanco y estructura de acero pintado por pulverización al horno de color negro. Peso neto 8 kg.

Foldable bench made in white high-density polyethylene with black powder-coated steel structure. Net weight 8 kg (17.64 lb).

Banquette pliante de polyéthylène d'haute densité en couleur blanc et structure en acier peint par pulvérisation au four en couleur noir. Poids net 8 kg.

Units STD	Packaging Dimensions (cm)	m3/ pack	NW Unit (kg)	Units Container 20'	Units Container 40'	Units Container HC	Units Traylor (70m3)	Units Truck 100m3
1	26x10x94	0,02	8	940	1.980	2.300	2.160	2.340
30	120x100x235	2,82	8	-	-	660	780	900

EASY STOOL



W 28 x L 32 x H 47 cm
 W 11.02 x L 12.60 x H 18.50 in

Ref. 66472

Taburete plegable de polietileno de alta densidad de color blanco y estructura de acero pintado por pulverización al horno de color negro. Peso neto 1,4 kg.

Foldable stool made in white high-density polyethylene with black powder-coated steel structure. Net weight 1,4 kg (3.09 lb).

Tabouret pliant de polyéthylène d'haute densité en couleur blanc et structure en acier peint par pulvérisation au four en couleur noir. Poids net 1,4 kg

Units STD	Packaging Dimensions (cm)	m3/ pack	NW Unit (kg)	Units Container 20'	Units Container 40'	Units Container HC	Units Traylor (70m3)	Units Truck 100m3
10	41x35x76	0,11	1,4	2.220	4.680	5.580	5.160	5.820

Mesa plegable con estructura de acero pintado en los diferentes acabados de pintura, con tubo de 28 mm. Tapa en los diferentes acabados.

Folding table with steel structure painted in different finishes with pipe of 28 mm. Cover in different finishes.

Plegable *Folding*

Interiores/cubierto *Indoor/cover*

Sólo en interiores *Indoor*

Útil para exteriores *Outdoor*



Bicapa aluminizado(L)
Bi-coat aluminized(L)

Blanco (B)
White (1)

Negro (N)
Black (T)

ESTRUCTURA FRAME	CODIGO CODE	MELAMINA MELAMINE	POLIMÉRICO POLYMERIC	COMPACTO COMPACT	80
		0628	Pintado en aluminio bicapa, o consultar colores <i>Painted in aluminium bicapa or see colors.</i>	0628L 0628B 0628N	

ESTRUCTURA FRAME	CODIGO CODE	MELAMINA MELAMINE	POLIMÉRICO POLYMERIC	COMPACTO COMPACT	80
		0623	Pintado en aluminio bicapa, o consultar colores <i>Painted in aluminium bicapa or see colors.</i>	0620L 0620B 0620N	

9,500 2 0,197



Bicapa aluminizado(L)
Bi-coat aluminized(L)

Blanco (B)
White (1)

Negro (N)
Black (T)

ESTRUCTURA FRAME	CODIGO CODE	MELAMINA MELAMINE	POLIMÉRICO POLYMERIC	COMPACTO COMPACT	60 100
		0625	Pintado en aluminio bicapa, o consultar colores <i>Painted in aluminium bicapa or see colors.</i>	0625L 0625B 0625N	

12,00 2 0,225

ESTRUCTURA FRAME	CODIGO CODE	MELAMINA MELAMINE	POLIMÉRICO POLYMERIC	COMPACTO COMPACT	80 120
		0629	Pintado en aluminio bicapa, o consultar colores <i>Painted in aluminium bicapa or see colors.</i>	0629L 0629B 0629N	

16,30 1 0,292



Bicapa aluminizado(L)
Bi-coat aluminized(L)

Blanco (B)
White (1)

Negro (N)
Black (T)

ESTRUCTURA FRAME	CODIGO CODE	MELAMINA MELAMINE	POLIMÉRICO POLYMERIC	COMPACTO COMPACT	70
		0627	Pintado en aluminio bicapa, o consultar colores <i>Painted in aluminium bicapa or see colors.</i>	0627L 0627B 0627N	

ESTRUCTURA FRAME	CODIGO CODE	MELAMINA MELAMINE	POLIMÉRICO POLYMERIC	COMPACTO COMPACT	70
		0620	Pintado en aluminio bicapa, o consultar colores <i>Painted in aluminium bicapa or see colors.</i>	0620L 0620B 0620N	

8,400 2 0,165

Compacto (e:10mm) Compact - C

- CB
- C6
- CK
- CJ
- CT
- CU
- C3
- CA
- CN
- CG
- CW
- CO
- CE

Polimérico (e:22mm) Polymeric - P

- PB
- PG
- PJ
- PT
- PU
- P3
- PN
- PW
- PO
- PH
- PF

Melamina (e:19mm) Melamine - F

- F



Silla con estructura de acero pintado en grafito. Asiento y respaldo en polietileno.
 Chair with steel structure graphite painted. Seat and back chair in polyethylene.

Plegable *Folding*
 Útil para exteriores *Outdoor*

	ESTRUCTURA <i>FRAME</i>	CODIGO <i>CODE</i>
0105	Acero pintado grafito <i>Graphite painted steel</i>	0105

POLIPROPILENO <i>POLYPROPYLENE</i>
32.00

86 | 45 | 54 | 47 4,400 4 0,133

Polipropileno *Polypropylene - R*

RB

Plegable *Folding*
 Útil para exteriores *Outdoor*



	ESTRUCTURA <i>FRAME</i>	CODIGO <i>CODE</i>
2820	Acero pintado grafito <i>Graphite painted steel</i>	2820

POLIETILENO <i>POLYETHYLENE</i>
77.00

75 | 122 15,80 1 0,087

75
182

	ESTRUCTURA <i>FRAME</i>	CODIGO <i>CODE</i>
2450	Acero pintado grafito <i>Graphite painted steel</i>	2450

POLIETILENO <i>POLYETHYLENE</i>
130.00

75 | 180 22,30 1 0,014

75
243



	ESTRUCTURA <i>FRAME</i>	CODIGO <i>CODE</i>
2180	Acero pintado grafito <i>Graphite painted steel</i>	2180

POLIETILENO <i>POLYETHYLENE</i>
194.00

75 | 180 22,30 1 0,014

180

by
maxchief

Zhuhai Shichang Metals, LTD
No.2 Chuangye Middle Road
Shuanglinpian Zone
Liangang Industrial Area
Zhuhai City
Guangdong Province 519045
CHINA

Maxchief Europe S.L.
Roger de Flor, 95
08013 Barcelona SPAIN
Tel. +34 93 453 66 00
Fax +34 93 451 88 94
info@maxchief.eu
www.maxchief.eu
www.zown.com



Download the Zown App for free
Available for iOS and Android tablets



 @zowncontract

 @zown.maxchief

 linkedin.com/company/maxchiefeurope

the classiccollection 2017

ZOWN

by **maxchief**

ZOWN

the classiccollection

2017

MAXCHIEF INVESTMENTS LTD.

MAXCHIEF INVESTMENTS LTD. is a holding company of Taiwanese origin with industrial plants in China, engaged primarily in the manufacture of office, garden and contract furniture. It set up "Dongguan Shichang Metals Factory Ltd." in August 1994 (65,000 m²) and the factory "Zhuhai Shichang Metals Ltd." in May 2010 (190,000 m²), where the holding company's main offices are currently found. MAXCHIEF EUROPE S.L. was established in August 2008 as the holding company's sales and marketing subsidiary in Barcelona, one of the world's benchmark cities for industrial design, innovation and creativity.

MAXCHIEF INVESTMENTS LTD es un holding de origen taiwanés con plantas industriales en China, principalmente dedicadas a la fabricación de mobiliario de oficina, jardín y hostelería. En Agosto de 1994 creó la fábrica "Dongguan Shichang Metals Factory Ltd" (65.000 m²) y en mayo de 2010 la fábrica "Zhuhai Shichang Metals Ltd" (190.000 m²), donde en la actualidad se encuentran las oficinas principales del holding. MAXCHIEF EUROPE S.L. se constituyó en Agosto de 2008 como filial comercial y de marketing del Holding en Barcelona, una de las ciudades de referencia en el mundo en lo que respecta al diseño industrial, la innovación y la creatividad.

MAXCHIEF INVESTMENTS LTD est une holding d'origine taiwanaise avec des usines industrielles en Chine, se consacrant essentiellement à la fabrication de mobilier de bureau, de jardin et d'hôtellerie. En août 1994, la holding a fondé l'entreprise "Dongguan Shichang Metals Factory Ltd" (65.000 m²). En mai 2010 est créée l'entreprise "Zhuhai Shichang Metals Ltd" (190 000 m²), où se trouvent actuellement ses bureaux principaux. MAXCHIEF EUROPE S.L. a été constituée en août 2008 comme filiale commerciale et marketing de la holding à Barcelone, une des villes de référence dans le monde en ce qui concerne le design industriel, l'innovation et la créativité.

MAXCHIEF INVESTMENTS LTD ist eine Holding aus Taiwan mit Fertigungswerken in China, in denen hauptsächlich Büro-, Garten- sowie Hotel- und Gastronomiemöbel hergestellt werden. Im August 1994 wurde das Werk „Dongguan Shichang Metals Factory Ltd“ (65.000 m²) und im Mai 2010 das Werk "Zhuhai Shichang Metals Ltd" (190.000m²) eröffnet, wo sich derzeit auch der Hauptsitz der Holding befindet. MAXCHIEF EUROPE S.L. wurde im August 2008 als Vertriebs- und Marketingtochter der Holding mit Sitz in Barcelona gegründet, einer der weltweit führenden Städte in den Bereichen Industriedesign, Innovation und Kreativität.



Zhuhai Shichang Metals Ltd.

Zhuhai, Guangdong, China

Dongguan Shichang Metals Factory Ltd.

Dongguan, Guangdong, China

- Engineering and Product Development
- Facilities equipped with cutting-edge technology
- Operations Management techniques seeking the highest quality and efficiency
- Ingeniería y Desarrollo de producto
- Instalaciones con tecnología de última generación
- Técnicas de Dirección de Operaciones orientada a la eficiencia y a la calidad total
- Ingénierie et Développement de produit
- Installations dotées d'une technologie de dernière génération
- Techniques de Direction des Opérations visant l'efficience et la qualité totale
- Produktentwicklung und Engineering
- Anlagen mit modernster Technologie
- Betriebsmanagement-Techniken zur Gewährleistung von Effizienz und umfassender Qualität

Maxchief Europe S.L.

Barcelona, Spain

- Market needs assessment
- Innovation, Creativity and Design
- European warranty
- Flexible and effective logistics
- Customer service
- Investigación de las necesidades del mercado
- Innovación, Creatividad y Diseño
- Garantía europea
- Logística flexible y eficaz
- Servicio al cliente
- Evaluation des besoins du marché
- Innovation, Créativité et Design
- Garantie européenne
- Logistique flexible et efficace
- Service au client
- Erforschung der Marktbedürfnisse
- Innovation, Kreativität und Design
- Gewährleistung europäischer Standards
- Flexible und effiziente Logistik
- Dienst am Kunden



ZOWN CONTRACT DESIGN FACTORY constitutes the holding company's brand targeting the **contract furniture** market, underpinned by a business philosophy which **integrates the entire value chain** (supply of raw materials, design, development, manufacture, distribution) and **combines the best of Asia and Europe** within one organisation.

From Asia, China brings its production potential and its modern infrastructure. Taiwan affords the management capacity of a management team boasting international training, expert in achieving high **productivity** and outstanding **quality** in factories equipped for large-scale production thanks to cutting-edge **technology**. In short, the keys to **competitiveness**.

From Europe, the team lends its expertise in **assessing the needs** of the global market, in **creativity** and in **design**. It manages **distribution** and provides a European **warranty** as well as effective and **flexible logistics**, basing its philosophy on the constant pursuit of innovation and commitment to customer **service**.

Since January 2015 Maxchief Europe S.L. has **internalised its logistics**, becoming established in a new industrial warehouse of 4,800 m² in Llinars del Vallès, Barcelona.

ZOWN CONTRACT DESIGN FACTORY es la marca del holding orientada al mercado del **mobiliario de uso profesional**, respaldada por una filosofía empresarial que **integra toda la cadena de valor** (aprovisionamiento de materias primas, diseño, desarrollo, fabricación, distribución) y **combina lo mejor de Asia y Europa** dentro de la misma organización.

Desde Asia, China aporta su potencial productivo y sus modernas infraestructuras. Taiwan, la capacidad de gestión de un equipo directivo con formación internacional, experimentados en obtener alta **productividad** en fábricas equipadas para la producción masiva con **sistemas de última generación**. En definitiva, las claves de la **calidad** y de la **competitividad**.

El equipo de Europa contribuye con la **investigación de las necesidades del mercado global**, la **creatividad** y el **diseño**. Gestiona la **distribución**, ofrece **garantía** europea así como una **logística flexible** y **eficaz**, basando siempre su trabajo en los pilares de la innovación y la obsesión por el **servicio al cliente**.

Desde Enero de 2015 Maxchief Europe S.L. **internaliza la función logística** estableciéndose en una nueva nave industrial de 4800 m² en Llinars del Vallès, Barcelona.



ZOWN CONTRACT DESIGN FACTORY est la marque du holding; ciblée sur le marché du **mobilier à usage professionnel**, elle repose sur une philosophie d'entreprise qui **intègre toute la chaîne de valeur** (approvisionnement en matières premières, conception, développement, fabrication, distribution) et qui **associe le meilleur de l'Asie et de l'Europe** au sein de la même organisation.

D'Asie, la Chine apporte son potentiel productif et ses infrastructures modernes ; Taiwan, la capacité de gestion d'une équipe de direction de formation internationale, experte pour obtenir une haute **productivité** et une haute **qualité** dans des usines équipées pour la production à grande échelle grâce à une **technologie** de dernière génération. En somme, les clés de la **compétitivité**.

D'Europe, l'équipe offre son expertise en matière d'**évaluation des besoins** du marché mondial, de créativité et de design. Elle gère la **distribution** et assure une **garantie** européenne, ainsi qu'une logistique flexible et efficace, sa philosophie étant fondée sur la recherche constante de l'**innovation** et sur son engagement envers le **service** à la clientèle.

Depuis janvier 2015, Maxchief Europe S.L. **internalise la fonction logistique** en établissant un nouveau bâtiment industriel de 4800 m² à Llinars del Vallès, province de Barcelone.

ZOWN CONTRACT DESIGN FACTORY ist die Marke der Holding für **Gewerbemöbel**, deren Unternehmensphilosophie die **gesamte Wertschöpfungskette** (Beschaffung der Rohstoffe, Design, Entwicklung, Herstellung, Vertrieb) **integriert** und **die Vorzüge Asiens und Europas** in einer Organisation **verbindet**.

In Asien steuert China sein Produktionspotential und seine modernen Infrastrukturen bei. Taiwan stellt die Führungsfähigkeiten eines Managementteams mit internationaler Ausbildung sowie Erfahrung in der Erzielung hoher **Produktivität** und **Produktqualität** in Großserienwerken mit modernster **Technologie** zur Verfügung, d.h. die Schlüssel der **Wettbewerbsfähigkeit**.

Das europäische Team trägt **Kreativität** und **Design** sowie seine Erfahrung in der Einschätzung der globalen **Marktbedürfnisse** bei. Darüber hinaus kümmert es sich um den Vertrieb und gewährleistet die Einhaltung europäischer Standards sowie eine effiziente und **flexible Logistik** auf der Grundlage einer Philosophie der ständigen **Innovation** und der Verpflichtung für den **Dienst am Kunden**.

Seit Januar 2015 hat Maxchief Europe S.L. **die Logistikkfunktion übernommen** und zu diesem Zweck eine neue, 4.800 m² große Industriehalle in Llinars del Vallès (Provinz Barcelona) bezogen.

FACTORY
FÁBRICA
USINE
WERK

Each and every member of the company team strives to constantly improve the level of quality and efficiency. In recognition of this commitment, the company was awarded the certifications for a quality management system (ISO 9001: 2008), environmental management system (ISO 14001: 2004) and occupational health and safety management system (OHSAS 18001: 2007).

Todo el equipo de la empresa trabaja orientado hacia la mejora continua de la calidad y la eficiencia. En reconocimiento a este compromiso, la compañía ha recibido certificaciones de gestión de la calidad (ISO 9001.2008), del impacto medioambiental (ISO 14001.2004), así como de la gestión de la salud y la seguridad en el trabajo (OHSAS18001.2007).

Toute l'équipe de l'entreprise travaille dans l'optique de l'amélioration continue de la qualité et de l'efficience. En reconnaissance à cet engagement, la compagnie a reçu les certifications de gestion de la qualité (ISO 9001.2008), de l'impact environnemental (ISO 14001.2004), ainsi que celle de la gestion de la santé et de la sécurité au travail (OHSAS18001.2007).

Der gesamte Mitarbeiterstab des Unternehmens ist auf die ständige Verbesserung der Qualität und Effizienz ausgerichtet. In Anerkennung dieses Engagements hat das Unternehmen Zertifizierungen in den Bereichen Qualitätsmanagement (ISO 9001.2008), Umweltmanagement (ISO 14001.2004) sowie Sicherheit und Gesundheit am Arbeitsplatz (OHSAS18001.2007) erhalten.



The factory is equipped with 41 HDPE blow moulding machines, 12 polypropylene injection machines and several steel pipe production lines. The factory is also fitted out with 45 digital welding robots and 4 powder coating lines. All of the above yields a production of between 600 and 800 containers per month.

Las plantas productivas cuentan con 41 máquinas de tecnología HDPE blow moulding, 12 inyectoras de Polipropileno y varias líneas de fabricación de tubo de acero. Disponen también de 45 robots de soldadura digital y 4 cadenas de pintado poder coating. Todo ello permite alcanzar producciones de 600 a 800 containers al mes.

Les ateliers de production disposent de 41 machines de technologie HDPE blow moulding, de 12 machines à injection de polypropylène et de plusieurs chaînes de fabrication de tubes en acier. Ils disposent également de 45 robots de soudage numérique et de 4 chaînes de peinture poder coating. Tout cela permet d'atteindre un rythme de production de 600 à 800 containers par mois.

Die Fertigungswerke verfügen über 41 HDPE-Blasformanlagen, 12 Polypropylen-Spritzgussanlagen und mehrere Produktionsstraßen für Stahlrohre. Dazu kommen 45 digitale Schweißroboter und 4 Pulverlackieranlagen. Dank dieser Einrichtungen können monatlich zwischen 600 und 800 Container mit unseren Produkten beladen werden.

ZOWN
WHY?
¿POR QUÉ?
POURQUOI?
WARUM?

Because the professional needs furniture:

Light and shock-proof. Stable and capable of withstanding weight. Durable, competitive and low-maintenance.

Comfortable for users. With a broad range of compatible models of various sizes. Assembled and disassembled rapidly, safely and repeatedly. Easily transported and stored, saving space.

Manufactured from easy-to-clean hygienic materials. Damp-proof and UV-proof. Suitable for indoor and outdoor use.

Porque el profesional necesita mobiliario:

Ligero y resistente a los impactos. Estable y adecuado para soportar peso. Duradero, competitivo y de bajo mantenimiento.

Cómodo para los usuarios. Con amplia variedad de modelos compatibles, de diferentes dimensiones.

Rápido y seguro para ser montado y desmontado con frecuencia. Fácil de transportar y de ser almacenado economizando espacio.

Fabricado con materiales higiénicos y fáciles de limpiar. Resistente a la humedad y a los rayos UV. Apropriado para uso interior y exterior.

Parce que les professionnels ont besoin de mobilier:

Léger et résistant en cas de choc. Stable et apte à supporter des charges lourdes. Durable, compétitif et nécessitant peu d'entretien.

Pratique pour les utilisateurs. Possédant une grande variété de modèles compatibles, de différentes dimensions.

Rapide et sûr pour être monté et démonté fréquemment. Facile à transporter et à stocker en économisant de l'espace.

Fabriqué à base de matériaux hygiéniques et faciles à nettoyer. Résistant à l'humidité et aux rayons UV. Apte pour usage intérieur et extérieur.

Weil Profis hohe Anforderungen an Möbel stellen:

Sie sollen leicht und schlagfest sein. Stabil und von hoher Tragkraft. Langlebig, preisgünstig und pflegeleicht.

Bequem für die Benutzer. Verfügbar in einer breiten Produktpalette und in unterschiedlichen Größen.

Schnell und sicher auf- und abzubauen. Leicht zu transportieren und platzsparend aufzubewahren.

Aus hygienischen Werkstoffen gefertigt und leicht zu reinigen. Feuchtigkeits- und UV-beständig. Geeignet sowohl für den Innen- als auch für den Außenbereich.



TABLE OF CONTENTS

tabla de contenidos / sommaire / inhaltsverzeichnis

INTRODUCTION

- Pg12 the**classic**collection presentation
- Pg18 the**textile**collection presentation
- Pg26 key / **leyenda** / légende / **legende**

M SYSTEM

- 45 cm / 18"
- Pg28 **M183**
- Pg29 **oxford180**

L SYSTEM

- 60 cm / 24"
- Pg30 **L120**
- Pg31 **Ltrolley**

XL SYSTEM

- 75 cm / 30"
- Pg34 **XL150**
- Pg36 **XL180**
- Pg38 **worktop180**
- Pg41 **topshelf180**
- Pg42 **XL240**
- Pg44 **XLtrolley**
- Pg46 **XLmoon**
- Pg48 **XLcorner**

XXL SYSTEM

- 90 cm / 36"
- Pg50 **XXL90**
- Pg52 **XXL200**
- Pg54 **XXL240**
- Pg56 **XXLcorner**
- Pg58 **XXLtrolley**
- Pg60 **XXLmoon**

PLANET SYSTEM

- ∅ ●
- Pg64 **planet120**
- Pg66 **planet150**
- Pg68 **planet160**
- Pg70 **planet180**
- Pg72 **planettrolley**

OTHER ITEMS

- Pg40 **buffettablebase**
- Pg74 **cocktail80**
- Pg78 **praxis80**
- Pg80 **bistro70** NEW
- Pg82 **cocktailtrolley**
- Pg84 **oktober175**
- Pg85 **sharpbench240**
- Pg86 **sharpbench180**
- Pg87 **sharptable**
- Pg88 **munich50** NEW
- Pg90 **munich70**
- Pg91 **munichbench**
- Pg92 **SS60**
- Pg93 **SS120**
- Pg113 **displayrack**

CHAIRS

- Pg76 **alvarstool**
- Pg96 **alexchair**
- Pg97 **alex-kchair**
- Pg100 **alexandrachair**
- Pg101 **alexandra-kchair**
- Pg102 **alexatrolley**
- Pg103 **alexandratrolley**
- Pg106 **ottochair**
- Pg107 **ottotrolley**
- Pg108 **normanchair**
- Pg109 **normantrolley**
- Pg110 **boston-kchair**
- Pg111 **liamtrolley**
- Pg112 **igorchair**

SUMMARY

- Pg115 **summary**

ZOWN

the **classic** collection

THE TESTER video!



We have performed a shock and load test comparing Zown folding tables with asian competitor's tables. **Watch the tester results!**

Hemos realizado pruebas de resistencia a impactos y de capacidad de carga comparando las mesas plegables de Zown con las mesas de los competidores asiáticos. **¡Mira los resultados de las pruebas!**

Nous avons effectué des essais de résistance aux chocs et aux charges en comparant les tables pliables de Zown à des tables fabriquées par des concurrents asiatiques. **Regardez les résultats!**

Wir haben die Klapptische von Zown in einem Stoß- und Lasttest mit Tischen asiatischer Mitbewerber verglichen. **Werfen Sie einen Blick auf die Testergebnisse!**

The ZOWN CLASSIC Collection features lightweight folding furniture for professional use at banquets and events, and in the hotel and catering industry. **Proven reliability.** Lightweight, shockproof, robust furniture with a weight-bearing capacity. Hard-wearing, **competitive** and low maintenance. **The widest variety of compatible models** of different sizes. Easy to assemble and disassemble, to transport and to store (saving on space). Hygienic and easy to clean. Resistant to moisture and UV rays. Suitable for indoor and outdoor use.

Colección ZOWN CLASSIC de mobiliario ligero plegable para uso profesional en banquetes, eventos, catering y hoteles. **Solvencia contrastada.** Mobiliario ligero y resistente a los impactos, estable y adecuado para soportar peso. Duradero, **competitivo** y de bajo mantenimiento. **La más amplia variedad de modelos** compatibles de diferentes dimensiones, Fácil de montar, desmontar, transportar y ser almacenado economizando espacio. Higiénico y fácil de limpiar. Resistente a la humedad y rayos UV. Apto para uso interior y exterior.

Collection ZOWN CLASSIC de mobilier léger et pliable pour usage professionnel lors de banquets, événements, buffets et en hôtel. **Fiabilité vérifiée.** Mobilier léger et résistant aux impacts, stable et capable de supporter un poids. Durable, **compétitif** et nécessitant peu d'entretien. **Large choix de modèles compatibles** de différentes dimensions. Facile à monter, à démonter, à transporter et à stocker avec gain de place. Hygiénique et facile à nettoyer. Résistant à l'humidité et aux rayons UV. Apte pour un usage intérieur et extérieur.

Die Kollektion ZOWN CLASSIC besteht aus leichten Klappmöbeln für den gewerblichen Einsatz bei Festessen, Veranstaltungen sowie im Catering- und Hotel-Bereich. **Im Einsatz bewährt.** Leichtes, schlagfestes, stabiles und belastbares Mobiliar. Langlebig, **preisgünstig** und pflegeleicht. Verfügbar in einer **breiten Produktpalette** und in unterschiedlichen Größen. Leicht auf- und abzubauen und zu transportieren. Platzsparend in der Lagerung. Hygienisch und leicht zu reinigen. Feuchtigkeits- und UV-beständig. Sowohl für den Innen- als auch für den Außenbereich geeignet.



Pure polyethylene, unmixed. Quality raw material with UV protection. Shock-proof. Constructed to withstand heavy loads. Suitable for outdoor use.

Polietileno puro, sin mezclas. Materia prima de calidad y con protección UV. Flexible ante los impactos. Resistente bajo cargas pesadas. Apto para uso exterior.

Polyéthylène pur, sans mélange. Matière première de qualité, protection contre les UV. Flexibilité en cas de chocs. Résistance aux charges lourdes. Apte pour usage extérieur.

Reines Polyethylen, ohne Beimischungen. Hochwertiges Ausgangsmaterial mit UV-Schutz. Schlagzäh und von hoher Tragfähigkeit. Für den Einsatz im Außenbereich geeignet.



Continuous digitally welded joints. Precise and indestructible. Powder coated steel. Shock-proof and damp-proof.

Soldaduras digitales en línea. Precisas e indestructibles. Acero pintado por pulverización, resistente a los impactos y a la humedad.

Soudage numérique en ligne. Précis et indestructible. Acier peint par pulvérisation, résistant aux chocs et à l'humidité.

Digital ausgeführte Schweißnähte, präzise und unzerstörbar. Pulverlackierter Stahl, schlagfest und feuchtigkeitsbeständig.



Metal profiles of a thickness designed to withstand extreme loads.

Perfiles metálicos con grosor dimensionado para soportar cargas extremas.

Profils métalliques d'une épaisseur apte à supporter des charges extrêmes.

Metallprofile von ausreichender Dicke für extreme Belastungen.

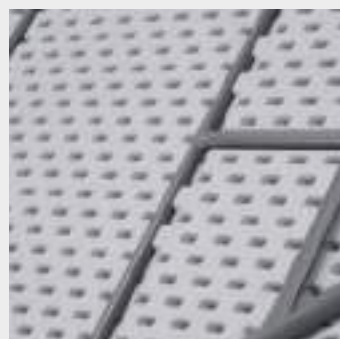

High density of vaults in the lower surface of the table top. Resistant and non-warping.

Alta densidad de bóvedas en el plano inferior del sobre. Resistente e indeformable.

Haute densité des voûtes sur le plan intérieur du plateau. Résistant et indéformable.

Zahlreiche wabenförmige Öffnungen an der Unterseite der Tischplatte. Strapazierfähig und unverformbar.

Individual polypropylene clip to hold the leg in position when folded. Solid and durable fastening device.

Clip independiente de polipropileno para albergar la pata en posición de plegado. Fijación perfecta y duradera.

Clip indépendant de polypropylène pour maintenir le pied en position pliée. Fixation parfaite et durable.

Unabhängige Klammer aus Polypropylen zur Aufnahme des Tischbeins in Klappposition. Perfekte und dauerhafte Fixierung.



Solid welded joints, nuts and bolts.

Tornillería y soldaduras sólidas.

Visserie et soudures solides.

Solide Schraub- und Schweißverbindungen.



Metal structures designed to optimise the weight/resistance ratio. The recommended maximum weight that appears on each page of the product refers to "evenly distributed" weight on the surface of the product. For the recommended maximum "concentrated" weight, please contact our sales department.

Estructuras metálicas diseñadas para optimizar la relación peso/resistencia. El peso máximo recomendado que figura en cada página de producto se refiere al peso "uniformemente repartido" en la superficie del artículo. Para conocer el peso "concentrado" máximo recomendado, consultar a nuestro departamento comercial.

Structures métalliques conçues pour un rapport poids/résistance optimal. Le poids maximum recommandé qui figure sur chaque page de produit se réfère au poids «réparti uniformément» sur la surface de l'article. Pour connaître le poids «concentré» maximum recommandé, consulter notre département commercial.

Speziell konstruierte Metallgestelle zur Optimierung des Verhältnisses zwischen Gewicht und Festigkeit. Das auf den einzelnen Produktseiten angegebene Maximalgewicht bezieht sich auf ein gleichmäßig auf der Oberfläche des Artikels verteiltes Gewicht. Auskünfte über das empfohlene maximale Punktgewicht erhalten Sie von unserer Verkaufsabteilung.



COMPOSITIONS COMPOSICIONES COMPOSITIONS ZUSAMMENSTELLUNGEN

The XL system is a set of tables 30" nominal wide (see exact measurements on each product page) which can be joined and combined to make multiple and diverse configurations. The XL system is specially designed for events in which optimising the available space constitutes a priority. The XXL system offers the same versatility but with tables 36" wide. The spacious XXL system makes for more elaborate arrangements as well as affording maximum comfort to table guests. The flexibility of the XL and XXL facilitates their adaptation to the unique attributes of every event.

El sistema XL es un conjunto de mesas con un ancho de 76 cm nominales (ver medidas exactas en cada página de producto) que se pueden unir y combinar para formar múltiples y variadas configuraciones. El sistema XL está especialmente indicado para aquellos eventos donde optimizar el espacio disponible es un factor clave.

El sistema XXL ofrece la misma versatilidad pero con mesas con un ancho de 90 cm nominales (ver medidas exactas en cada página de producto). El espacioso sistema XXL permite decoraciones de mayor vistosidad, además de otorgar excelente confort a los comensales.

La flexibilidad de los sistemas XL y XXL permite adaptarse a las singularidades de cada evento.

Le système XL est un ensemble de tables d'une largeur nominale de 76 cm (voir dimensions exactes sur chaque page de produit) que l'on peut assembler et combiner selon des configurations multiples et variées. Le système XL est particulièrement indiqué pour les événements où l'optimisation de l'espace disponible est un facteur clé.

Le système XXL offre la même polyvalence mais avec des tables de 90 cm de largeur nominale (voir dimensions exactes sur chaque page de produit). Le système XXL, particulièrement spacieux, permet non seulement un type de décoration plus élégante mais assure également un confort d'excellente qualité pour les convives.

La flexibilité des systèmes XL et XXL permet de s'adapter aux singularités de chaque événement.

Das System XL besteht aus Tischen mit einer Breite von 76 cm (genaue Abmessungen siehe jeweilige Produktseite), die auf verschiedenste Weise und in unterschiedlichsten Konfigurationen kombiniert werden können. Das System XL ist besonders für jene Anlässe geeignet, in denen es auf die optimale Nutzung des verfügbaren Raumes ankommt.

Das System XXL bietet die gleiche Vielseitigkeit jedoch mit einer Tischbreite von 90 cm (genaue Abmessungen siehe jeweilige Produktseite). Das großzügige System XXL erlaubt eine aufwändigere Dekoration und bietet den Gästen einen besonderen Komfort.

Die Flexibilität der Systeme XL und XXL ermöglicht es, die Besonderheiten der jeweiligen Veranstaltung zu berücksichtigen.



Transverse / longitudinal table joining system
Sistema de unión transversal / longitudinal
Système d'assemblage transversal / longitudinal
Quer Verbindungssystem / Längs Verbindungssystem



Angular table joining system
Sistema de unión angular
Système d'assemblage angulaire
Eckverbindungssystem



Circular table joining system
Sistema de unión circular
Système d'assemblage circulaire
Kreisförmiges Verbindungssystem

XL SYSTEM

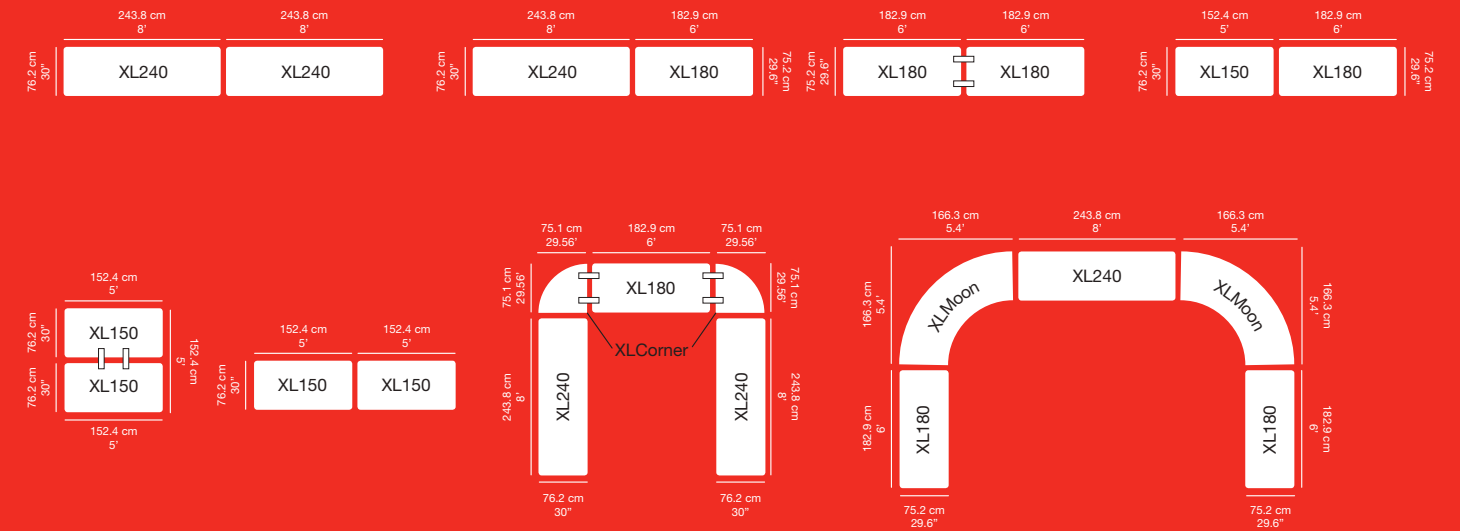

XL SYSTEM + planet180

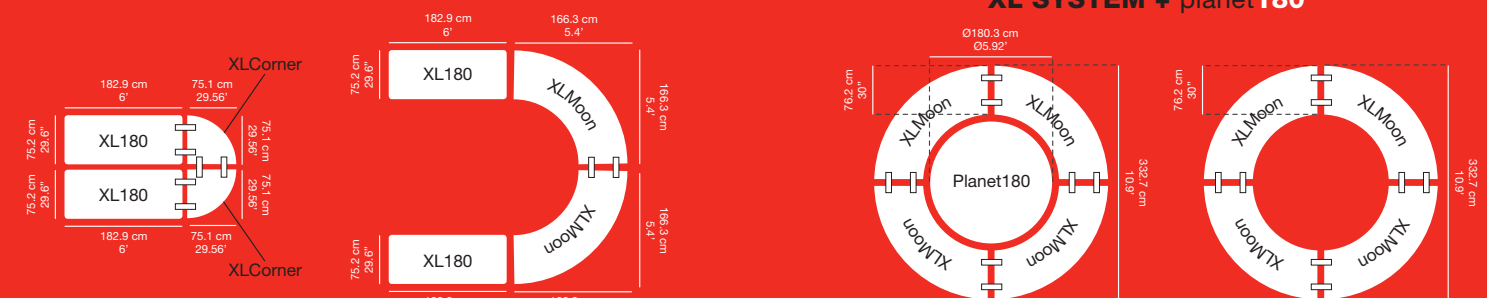

XXL SYSTEM

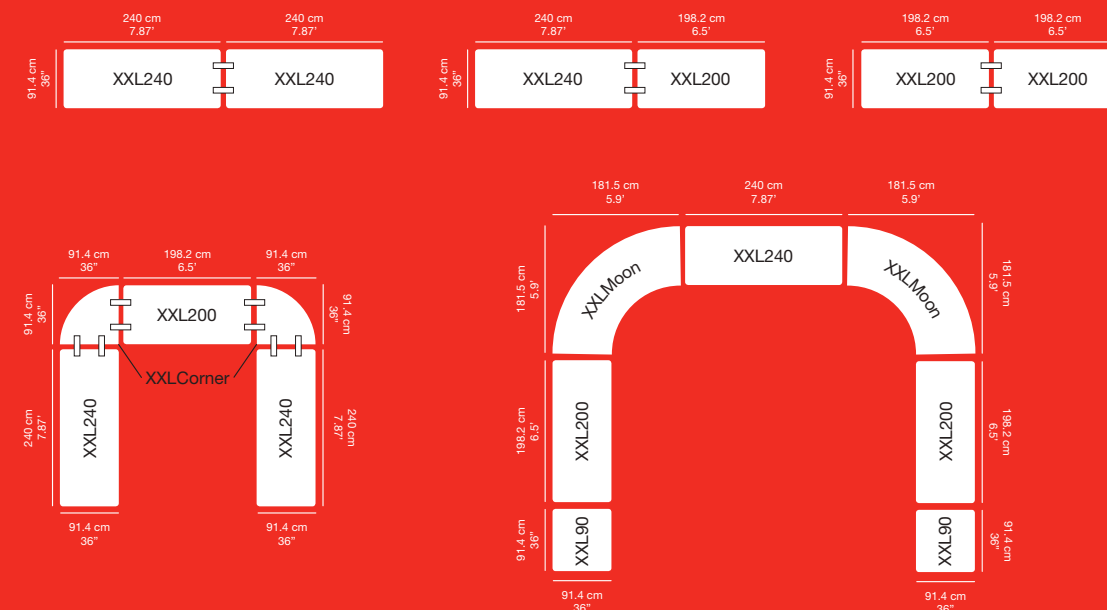

XXL SYSTEM + planet180

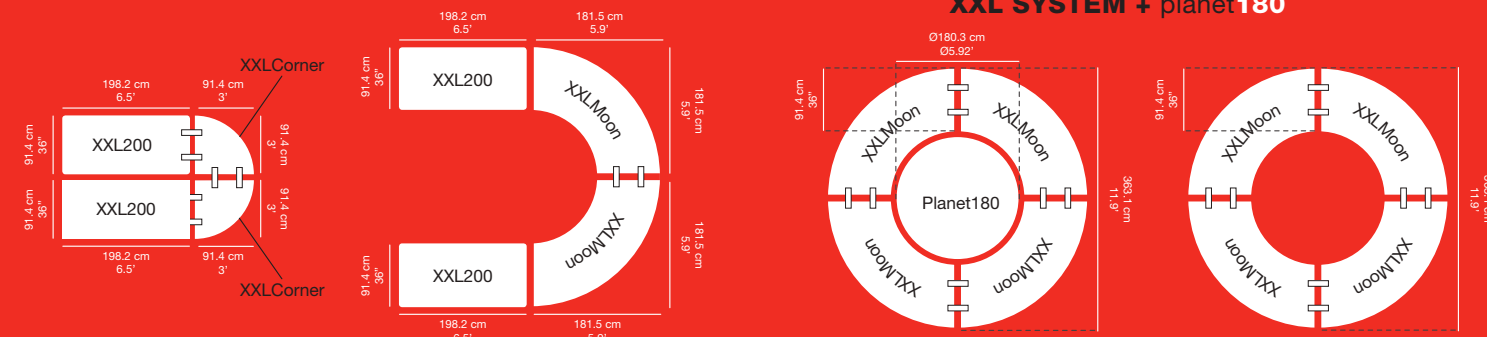

thetextilecollection









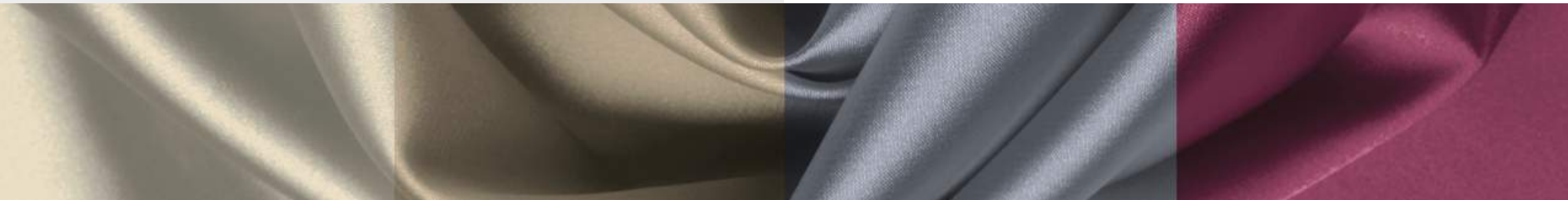





The Zown Textile Collection comprises a range of standard furniture covers especially designed to fit each of Zown's classic products. A broad spectrum of styles and solid colours are available. This Textile Collection is set apart by:

- Styles fully in line with Zown's classic product range of furniture.
- Fabrics and weights which have been selected to strike the perfect balance between performance, aesthetics and durability.
- Special stitching designed to create strong seams and fray-resistant edges in order to withstand wear and tear.
- Crease-resistant fabrics, which are easy to wash and iron, retaining their shape and with no shrinkage.
- Stretch fabric containing 10% Lycra, which is elastic and returns to its original shape without any deformation.

La colección textil de Zown comprende toda una gama de fundas para muebles estándar especialmente diseñada para que se adapte a todos y cada uno de los productos de la colección Zown Classic. Disponibles en un amplio abanico de estilos y colores sólidos, los artículos de esta colección se distinguen por:

- Patrones perfectamente ajustados a la colección de muebles Zown classic.
- Las telas y sus gramajes han sido seleccionados para lograr el equilibrio perfecto entre rendimiento, estética y durabilidad.
- Costuras especialmente confeccionadas para crear uniones fuertes que soporten bien los tirones y bordes resistentes que no se deshilachen.
- Tejidos resistentes a las arrugas y fáciles de lavar y planchar. Mantienen su forma sin encogerse.
- Tejidos stretch con un 10% de lycra, les dota de elasticidad y les permite recuperar su forma original sin deformarse.



 White - Blanco Blanc - Weiß	 White - Blanco Blanc - Weiß
 Ecrú - Blanco roto Blanco roto - Blanco roto	 Ecrú - Blanco roto Blanco roto - Blanco roto
 Sand - Arena Sable - Sand	 Sand - Arena Sable - Sand
 Anthracite - Antracita Anthracite - Anthrazit	 Anthracite - Antracita Anthracite - Anthrazit
 Black - Negro Noir - Schwarz	 Black - Negro Noir - Schwarz
 Burgundy - Burdeos Bordeaux - Bordeaux	 Burgundy - Burdeos Bordeaux - Bordeaux
 Red - Rojo Rouge - Rot	 Blue - Azul Bleu - Blau

La Collection Textile Zown est constituée d'une gamme de housses de meubles standard, spécialement conçues pour s'adapter à chaque produit Zown classic. Un large choix de styles et de couleurs unies est disponible. Cette Collection Textile se distingue grâce aux éléments suivants:

- Styles en accord parfait avec la gamme de meubles Zown classic.
- Tissus et poids pensés pour obtenir l'équilibre parfait entre performance, esthétique et durabilité.
- Mode de fabrication spécialement mis au point pour obtenir des coutures durantes et des bords qui ne s'effilochent pas, afin de résister à l'usure naturelle.
- Tissus anti-plis, faciles à laver et à repasser, qui conservent leur forme et ne rétrécissent pas.
- Tissu stretch contenant 10% de lycra : élastique, il reprend sa forme d'origine sans aucune déformation.

Die Textil-Kollektion von Zown beinhaltet verschiedene Standard-Hussen, die speziell den einzelnen Zown-Classic-Produkten angepasst sind. Zur Auswahl steht eine breite Palette an Modellen und beständigen Farben. Die Textil-Kollektion besticht durch folgende Merkmale:

- Die Modelle sind vollständig auf die Zown-Classic-Möbel abgestimmt.
- Die Stoffe und Stärken zielen auf ein perfektes Gleichgewicht aus Leistung, Ästhetik und Strapazierfähigkeit.
- Verschleißbeständige Spezialnähte für dauerhaft feste Säume und fransenlose Ränder.
- Pflegeleichte, faltenbeständige Stoffe, die ihre Form beim Waschen und Bügeln behalten und nicht eingehen.
- Elastischer Stretch-Stoff mit 10% Lycra, nimmt ohne Verziehen wieder seine Ausgangsform ein.

SPECIAL FEATURES

características especiales / caractéristiques spéciales / besondere merkmale



Indelible label sewn to the product which clearly indicates its name and use for rapid identification and classification, thereby avoiding confusion and time-wasting.

Etiquetas indelebles cosidas al producto que indican claramente su nombre y utilidad para una rápida identificación y clasificación, evitando desórdenes y pérdidas de tiempo.

Étiquettes indélébiles cousues aux produits indiquant clairement leur nom et leur utilité pour une identification et un tri rapides, évitant ainsi désordres et pertes de temps.

Am Produkt festgenähte, unlöschbare Etiketten mit klarer Angabe des Namens und Verwendungszwecks für eine rasche Identifikation und Sortierung, um Verwirrung und unnötigen Zeitaufwand zu vermeiden.



Crease-resistant fabrics, which are easy to wash and iron, retaining their shape and with no shrinkage.

Tejidos resistentes a las arrugas y fáciles de lavar y planchar. Mantienen su forma sin encogerse.

Tissus anti-plis, faciles à laver et à repasser, qui conservent leur forme et ne rétrécissent pas.

Pflegeleichte, faltenbeständige Stoffe, die ihre Form beim Waschen und Bügeln behalten und nicht eingehen.



Special stitching designed to create strong seams and fray-resistant edges in order to withstand wear and tear.

Costuras especialmente confeccionadas para crear uniones fuertes que soporten bien los tirones y bordes resistentes que no se deshilachen.

Mode de fabrication spécialement mis au point pour obtenir des coutures durantes et des bords qui ne s'effilochent pas, afin de résister à l'usure naturelle.

Verschleißbeständige Spezialnähte für dauerhaft feste Säume und fransenlose Ränder.



Attractive packaging which clearly identifies its content and use, facilitating its classification, display and storage.

Embalajes atractivos que identifican claramente su contenido y utilidad, facilitando su clasificación, exposición y conservación.

Emballages attrayants qui permettent d'identifier clairement leur contenu et l'utilité des produits, facilitant ainsi leur tri, leur exposition et leur entreposage.

Attraktive Verpackungen mit klarer Angabe von Inhalt und Verwendungszweck zur einfacheren Sortierung, Ausstellung und Aufbewahrung.



STYLES

estilos / styles / stile

Full Table, Bench and Top Cover Shapes

NEW COLOURS

stretch

90% PES 10% LYCRA,
190-200 g/m², knitted



- White - Blanco
Blanc - Weiß
- Ecru - Crudo
Écru - Cremeweiß
- Sand - Arena
Sable - Sand
- Anthracite - Antracita
Anthracite - Anthrazit
- Black - Negro
Noir - Schwarz
- Burgundy - Burdeos
Bordeaux - Bordeaux
- Red - Rojo
Rouge - Rot

paramount

100% PES,
190-200 g/m², knitted



- White - Blanco
Blanc - Weiß
- Ecru - Crudo
Écru - Cremeweiß
- Sand - Arena
Sable - Sand
- Anthracite - Antracita
Anthracite - Anthrazit
- Black - Negro
Noir - Schwarz
- Burgundy - Burdeos
Bordeaux - Bordeaux
- Blue - Azul
Bleu - Blau

plain

100% PES,
190-200 g/m², knitted



- White - Blanco
Blanc - Weiß
- Ecru - Crudo
Écru - Cremeweiß
- Sand - Arena
Sable - Sand
- Anthracite - Antracita
Anthracite - Anthrazit
- Black - Negro
Noir - Schwarz
- Burgundy - Burdeos
Bordeaux - Bordeaux
- Blue - Azul
Bleu - Blau

bridge

100% PES,
190-200 g/m², knitted



- White - Blanco
Blanc - Weiß
- Ecru - Crudo
Écru - Cremeweiß
- Sand - Arena
Sable - Sand
- Anthracite - Antracita
Anthracite - Anthrazit
- Black - Negro
Noir - Schwarz
- Burgundy - Burdeos
Bordeaux - Bordeaux
- Blue - Azul
Bleu - Blau

Partial Table Skirt

paramount

100% PES,
190-200 g/m², knitted



- White - Blanco
Blanc - Weiß
- Ecru - Crudo
Écru - Cremeweiß
- Sand - Arena
Sable - Sand
- Anthracite - Antracita
Anthracite - Anthrazit
- Black - Negro
Noir - Schwarz
- Burgundy - Burdeos
Bordeaux - Bordeaux
- Blue - Azul
Bleu - Blau

Chair Cover Shapes

stretch

90% PES 10% LYCRA,
190-200 g/m², knitted



- White - Blanco
Blanc - Weiß
- Ecru - Crudo
Écru - Cremeweiß
- Sand - Arena
Sable - Sand
- Anthracite - Antracita
Anthracite - Anthrazit
- Black - Negro
Noir - Schwarz
- Burgundy - Burdeos
Bordeaux - Bordeaux
- Red - Rojo
Rouge - Rot

classic

100% PES,
190-200 g/m², knitted



- White - Blanco
Blanc - Weiß
- Ecru - Crudo
Écru - Cremeweiß
- Sand - Arena
Sable - Sand
- Anthracite - Antracita
Anthracite - Anthrazit
- Black - Negro
Noir - Schwarz
- Burgundy - Burdeos
Bordeaux - Bordeaux
- Blue - Azul
Bleu - Blau

Chair Sash Shapes

plain

90% PES 10% LYCRA,
190-200 g/m², knitted



- White - Blanco
Blanc - Weiß
- Ecru - Crudo
Écru - Cremeweiß
- Sand - Arena
Sable - Sand
- Anthracite - Antracita
Anthracite - Anthrazit
- Black - Negro
Noir - Schwarz
- Burgundy - Burdeos
Bordeaux - Bordeaux
- Red - Rojo
Rouge - Rot

twist

90% PES 10% LYCRA,
190-200 g/m², knitted



classic

90% PES 10% LYCRA,
190-200 g/m², knitted



Tablecloths

tablecloths

100% CO,
230 g/m²

- White - Blanco
Blanc - Weiß



Top Cover

stretch

90% PES 10% LYCRA,
200 g/m², knitted



- White - Blanco
Blanc - Weiß
- Ecru - Crudo
Écru - Cremeweiß
- Sand - Arena
Sable - Sand
- Anthracite - Antracita
Anthracite - Anthrazit
- Black - Negro
Noir - Schwarz
- Burgundy - Burdeos
Bordeaux - Bordeaux
- Red - Rojo
Rouge - Rot

Extra colours for cocktail table stretch cover and top cover Green - Verde
Vert - Grün Orange - Naranja
Orange - Orange Turquoise - Turquesa
Turquoise - Türkis Pink - Rosa
Rose - Rosa

COLOURS
colores / couleurs / farben

stretch Table, Bench and Chair Cover Colours 90% PES 10% LYCRA, 200 g/m², knitted



paramount Cover and Partial-Skirt Colours 100% PES, 200 g/m², knitted



plain Cover Colours 100% PES, 200 g/m², knitted



bridge Cover Colours 100% PES, 200 g/m², knitted



stretch Chair Cover Colours 90% PES 10% LYCRA, 200 g/m², knitted



classic Chair Cover Colours 100% PES, 200 g/m², knitted



Chair sash Colours 90% PES 10% LYCRA, 200 g/m², knitted



Colour of Cotton Tablecloths and Napkins



KEY

leyenda / légende / legende

Limited
10-year
warranty

Limited
5-year
warranty

Ten-year or five-year limited warranty for products where expressly indicated on the corresponding catalogue page. For all other products, the European two-year legal guarantee shall apply. **See conditions on www.zown.com/warranty.**

Garantía limitada de 10 o 5 años para aquellos productos en los que así se indique en la correspondiente página del catálogo. Para el resto de productos será aplicable la garantía legal europea de 2 años. **Consultar condiciones en www.zown.com/warranty.**

10 ou 5 ans de garantie limitée pour tous les produits dont la description contient cette indication (veuillez vous reporter à la page correspondante du catalogue). Pour tous les autres produits, c'est la garantie légale européenne de deux ans qui sera appliquée. **Consulter les conditions sur www.zown.com/warranty.**

Auf Waren mit der entsprechenden Angabe auf der jeweiligen Katalogseite leisten wir 10 bzw. 5 Jahre beschränkte Garantie. Für die anderen Waren gilt die gesetzliche europäische Garantiefrist von 2 Jahren. **Bedingungen siehe www.zown.com/warranty.**



High-density polyethylene table top, chair or bench seat and backrest. Powder-coated steel frame.

Sobre de mesa, o asiento y respaldo de silla o banco, en polietileno de alta densidad. Estructura de acero pintado por pulverización.

Plateau de table, ou siège et dossier de chaise ou de banc, en polyéthylène haute densité. Structure en acier peint par pulvérisation.

Tischplatte bzw. Sitzfläche und Rückenlehne von Stuhl bzw. Bank aus HDPE. Gestell aus pulverbeschichtetem Stahl.

Light Grey / Gris Claro / Gris Clair / Hellgrau
Grey / Gris / Gris / Grau

Brown / Marrón / Marron / Braun
Green / Verde / Vert / Grün

White / Blanco / Blanc / Weiß
Black / Negro / Noir / Schwarz

White / Blanco / Blanc / Weiß
White / Blanco / Blanc / Weiß

Dark Bronze / Bronce Oscuro / Bronzé Foncé / Dunkle Bronze
Dark Bronze / Bronce Oscuro / Bronzé Foncé / Dunkle Bronze



Powder-coated steel frame. Grey.

Estructura de acero pintado por pulverización. Gris.

Structure en acier peint par pulvérisation. Gris.

Gestell aus pulverbeschichtetem Stahl. Grau.



Polypropylene chair seat and backrest. Powder-coated steel frame.

Asiento y respaldo de la silla de polipropileno. Estructura de acero pintado por pulverización.

Siège et dossier de la chaise en polypropylène. Structure en acier peint par pulvérisation.

Sitzfläche und Rückenlehne des Stuhls aus Polypropylen. Gestell aus pulverbeschichtetem Stahl.

Light Grey / Gris Claro / Gris Clair / Hellgrau
Grey / Gris / Gris / Grau

White / Blanco / Blanc / Weiß
White / Blanco / Blanc / Weiß

Black / Negro / Noir / Schwarz
Black / Negro / Noir / Schwarz



SS304: Stainless steel table.

Mesa de acero inoxidable SS304.

Table en acier inoxydable SS304.

SS304: Tisch aus Edelstahl.

Upholstered seat and backrest. Powder-coated steel frame.

Asiento y respaldo tapizados. Estructura de acero pintado por pulverización.

Siège et dossier rembourrés. Structure en acier peint par pulvérisation.

Sitzfläche und Rückenlehne gepolstert. Gestell aus pulverbeschichtetem Stahl.

Black / Negro / Noir / Schwarz
Silver / Plata / Argent / Silber

Blue / Azul / Bleu / Blau
Silver / Plata / Argent / Silber

Black / Negro / Noir / Schwarz
Gold / Dorado / Doré / Gold

Grey / Gris / Gris / Grau
Silver / Plata / Argent / Silber

Red / Rojo / Rouge / Rot
Silver / Plata / Argent / Silber

Black / Negro / Noir / Schwarz
Black / Negro / Noir / Schwarz



Evenly distributed maximum weight load the table can withstand for 24 hours without causing severe deformation that would prevent its use.

Peso máximo recomendado uniformemente repartido que puede soportar la mesa durante 24h sin causar un grado de deformación severo que impida su uso.

Poids maximum recommandé, réparti de façon uniforme, supporté par la table pendant 24 h sans provoquer de déformation sévère susceptible d'empêcher son utilisation.

Maximal empfohlene Last, der der Tisch bei gleichmäßiger Lastverteilung 24 Stunden lang standhält, ohne starke Verformungen zu erleiden, die seine Einsatztauglichkeit gefährden.



Recommended maximum weight.

Peso máximo recomendado.

Poids maximum recommandé.

Empfohlenes Höchstgewicht.



Net product weight.

Peso neto del producto.

Poids net du produit.

Nettogewicht des Artikels.



UV-protected and water-resistant. Ideal for extensive but not permanent outdoor use.

Protección UV y Hidrófuga. Ideal para uso exterior extensivo, pero no permanente.

Protection UV et hydrofuge. Idéal pour un usage extérieur extensif, mais non permanent.

UV-geschützt und wasserabstoßend. Ideal zur extensiven, aber nicht dauernden Verwendung im Freien.



Seating capacity of the table.

Máximo número recomendado de comensales por mesa.

Nombre maximum recommandé de personnes par table.

Anzahl der Sitzplätze pro Tisch.



Conference table with ergonomic frame.
Mesa para conferencias con estructura ergonómica.
Table pour conférences avec une structure ergonomique.
Konferenztisch mit ergonomischem Gestell.

M183

TABLE MESA TABLE TISCH



Limited
10-year
warranty

Conference table with wheels, folding table top and modesty panel.
Mesa para conferencias con ruedas, sobre abatible y panel de intimidad.
Table pour conférences à roulettes, surface rabattable et panneau de séparation.
Konferenztisch mit Rädern, klappbarer Tischplatte und Fußraumblende.

oxford180

TABLE MESA TABLE TISCH



thetextilecollection



Hinged table top with a special mechanism for folding the table gently and smoothly. Compact storage of multiple tables when locked in the upright position.
Sobre abatible con mecanismo especial para un descenso suave sin impacto. Con el sobre bloqueado en posición vertical, las mesas se acoplan economizando espacio.
Plateau rabattable à l'aide d'un mécanisme spécial pour un abaissement en douceur, sans impact. Lorsque le plateau est bloqué en position verticale, les tables peuvent se raccorder, ce qui économise de l'espace.
Klappbare Platte mit Spezialvorrichtung zum sanften, stoßlosen Einklappen. Platzsparende Aufbewahrung mehrerer Tische mit senkrecht verriegelter Platte.

Code Código Code Code	EAN	Name Nombre Nom Name	Units per box Unidades por caja Unités par boîte Stückzahl pro Packung	Packaging size Medidas embalaje Dimensions emballage Verpackungsmaße	Packaging volume Volumen embalaje Volume d'emballage Verpackungsvolumen	Gross weight Peso bruto Poids brut Bruttogewicht	Loading quantity Unidades por contenedor Unités par conteneur Einheiten pro Container
PT-033	8436539296577	M183	1	185.4 x 47.6 x 5.7 cm 73" x 18.7" x 2.3"	0.050 m ³ 1.776 ft ³	12.47 kg 27.43 lb	Container 40': 1100 Container 40' HC: 1220

Code Código Code Code	EAN	Name Nombre Nom Name	Units per box Unidades por caja Unités par boîte Stückzahl pro Packung	Packaging size Medidas embalaje Dimensions emballage Verpackungsmaße	Packaging volume Volumen embalaje Volume d'emballage Verpackungsvolumen	Gross weight Peso bruto Poids brut Bruttogewicht	Loading quantity Unidades por contenedor Unités par conteneur Einheiten pro Container
PT-035	8436539296584	oxford180	1	181.9 x 58.4 x 12.7 cm 71.6" x 23" x 5"	0.1349 m ³ 4.763 ft ³	25.29 kg 55.64 lb	Container 40': 446 Container 40' HC: 508

Multi-purpose side table.
Mesa auxiliar multiusos.
Table auxiliaire multi-usages.
Mehrzweck-Beistelltisch.

L120

TABLE MESA TABLE TISCH



8.5 kg
18.7 lb



205 kg
450 lb



Water-resistant



HDPE Light Grey
POWDER-COATED STEEL Grey

Limited
10-year
warranty

Special trolley for the L120 table.
Carro especial para la mesa L120.
Chariot spécial pour la table L120.
Spezialwagen für den Tisch L120.

Ltrolley

TROLLEY CARRO CHARIOT WAGEN



21.3 kg
46.9 lb



POWDER-COATED STEEL Grey



Sliding ring to lock the legs in position when in use. Easy and secure.

Argolla autodeslizante para bloquear las patas en posición de uso. Fácil y seguro.

Anneau autoglissant pour blocage des pieds en position d'usage. Facile et sûr.

Selbstgleitender Metallschiebering zur Feststellung der aufgeklappten Tischbeine. Einfach und sicher.



Ltrolley available for 20 tables. See page 31.

Carro Ltrolley disponible para 20 mesas. Ver pág. 31.

Chariot Ltrolley disponible pour 20 tables. Voir page 31.

Wagen Ltrolley lieferbar für 20 Tische. Siehe S. 31.



Peripheral posts to hold the stacked tables in place.

Postes périphériques pour immobiliser les tables empilées.

Poteaux périmétraux pour immobiliser des tables empilées.

Sicherungsstangen verhindern das Verrutschen der gestapelten Tische.



Handle specially designed to protect the hands.

Asa especial para proteger las manos.

Anse spécialement conçue pour protéger les mains.

Ein spezieller Griff schützt die Hände.



Four polyurethane wheels with built-in brake. (Two fixed wheels and two pivoting wheels).

4 ruedas de poliuretano con freno incorporado (2 ruedas fijas y 2 ruedas pivotantes).

4 roulettes en polyuréthane avec frein intégré. (2 roulettes fixes et 2 roulettes pivotantes).

4 PU-Räder mit integrierter Bremse. (2 feststehende Räder und 2 Schwenkräder).



Capacity: 20 pcs. L120.

Capacidad: 20u. L120.

Capacité: 20u. L120.

Fassungsvermögen: 20 Stk. L120.

thetextilecollection

stretch



paramount



plain

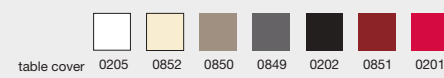

top cover 0438 0856 0854 0853 0435 0855 0434

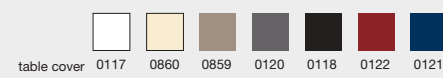

tablecloth 0548

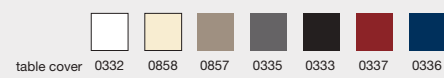
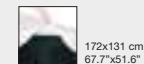

tablecloth 0548

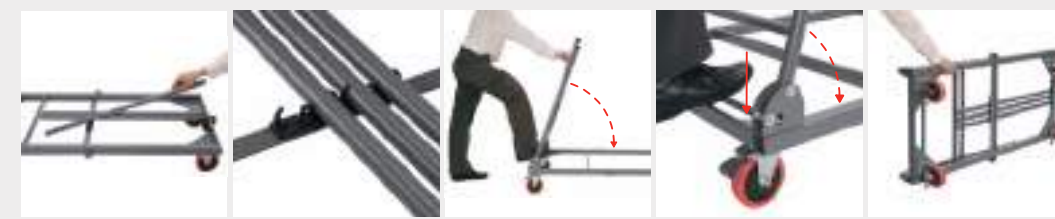
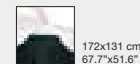

Part to hold the removable posts when folded. Bar with automatic unlocking mechanism which allows the vertical bracket to be folded. Trolley in fully folded position. Occupies a minimum of space. All parts are integrated to prevent loss.

Pieza para sujetar los postes extraíbles en posición de plegado. Barra con mecanismo automático para desbloquear y permitir el plegado del soporte vertical. Carro totalmente plegado. Ocupa mínimo espacio y todos sus componentes quedan integrados para no extraviarlos.

Pièce pour poteaux extractibles en position de pliage. Barre avec mécanisme automatique pour blocage et déblocage et pour permettre le pliage du support vertical. Chariot entièrement plié. Occupe peu de place. Tous ses composants sont intégrés pour ne pas les perdre.

Haltevorrichtung für die herausnehmbaren Stangen in abgeklappter Position. Stange mit automatischem Mechanismus zum Entriegeln und Zusammenklappen des senkrechten Gestells. Der Wagen lässt sich vollständig zusammenklappen. Platzsparend sind alle Bestandteile integriert, damit sie nicht verloren gehen.

Code Código Code Code	EAN	Name Nombre Nom Name	Units per box Unidades por caja Unités par boîte Stückzahl pro Packung	Packaging size Medidas embalaje Dimensions emballage Verpackungsmaße	Packaging volume Volumen embalaje Volume d'emballage Verpackungsvolumen	Gross weight Peso bruto Poids brut Bruttogewicht	Loading quantity Unidades por contenedor Unités par conteneur Einheiten pro Container
BT-04B	8437009886151	L120	1	124.8 x 63.5 x 6 cm 49.1" x 25" x 2.4"	0.048 m ³ 1.695 ft ³	9.8 kg 21.56 lb	Container 40': 1270 Container 40' HC: 1500

Code Código Code Code	EAN	Name Nombre Nom Name	Units per box Unidades por caja Unités par boîte Stückzahl pro Packung	Packaging size Medidas embalaje Dimensions emballage Verpackungsmaße	Packaging volume Volumen embalaje Volume d'emballage Verpackungsvolumen	Gross weight Peso bruto Poids brut Bruttogewicht	Loading quantity Unidades por contenedor Unités par conteneur Einheiten pro Container
RA-101A	8437009886014	Ltrolley	1	138.4 x 72.4 x 15.2 cm 54.5" x 28.5" x 6"	0.152 m ³ 5.367 ft ³	23.9 kg 52.5 lb	Container 40': 409 Container 40' HC: 440



XL150

TABLE MESA TABLE TISCH



Limited
10-year
warranty



H74.3 cm
H29.2"

45 mm

L152.4 x W76.2 cm
L5' x W30"

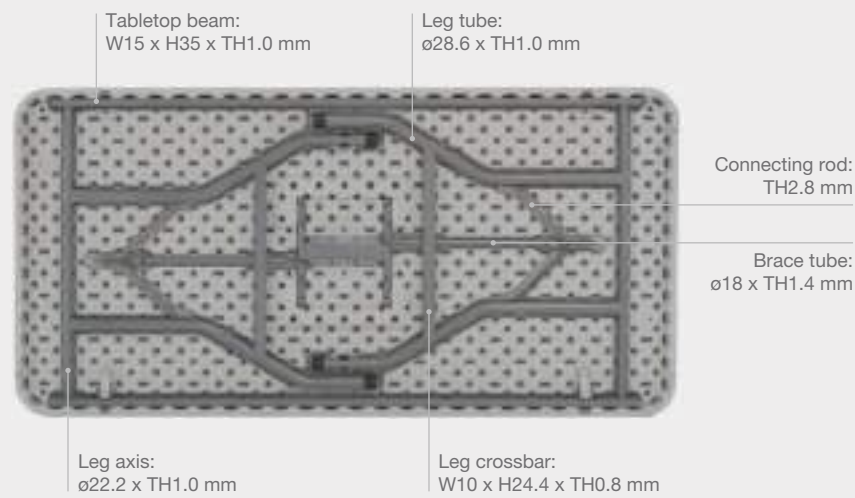
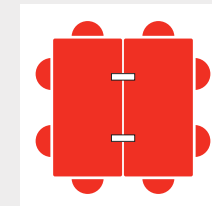
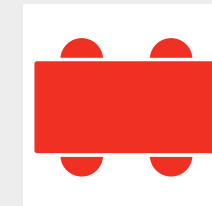

Table with transverse joining system, ideal for 152 x 152 cm square configurations, joining two tables.
Mesa con sistema de unión transversal ideal para composiciones cuadradas de 152 x 152 cm uniendo dos mesas.
Table dotée d'un système de raccord transversal, idéal pour des modules carrés de 152 par 152 cm servant à relier deux tables.
Tisch mit Querverbindungssystem, ideal für eine quadratische Anordnung zweier Tische (152 x 152 cm).



Transverse table joining system.
Sistema de unión transversal de mesas.
Système de raccord transversal de tables.
Vorrichtung zur querseitigen Verbindung der Tische.



Capacity: 4 persons.
Area per person: 29.9".
Capacidad: 4 personas.
Espacio por persona: 76 cm.
Capacité: 4 personnes.
Espace par personne: 76 cm.
Bietet Platz für 4 Personen.
Platz pro Person: 76 cm.

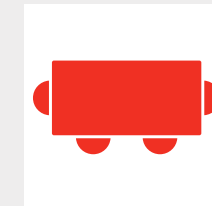

Capacity: 4 persons.
Area per person: 24".
Capacidad: 4 personas.
Espacio por persona: 61 cm.
Capacité: 4 personnes.
Espace par personne: 61 cm.
Bietet Platz für 4 Personen.
Platz pro Person: 61 cm.

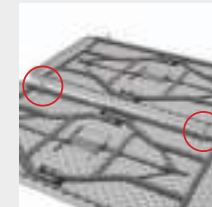

Transverse table joining system.
Sistema de unión transversal de mesas.
Système de raccord transversal de tables.
Vorrichtung zur querseitigen Verbindung der Tische.



Sliding ring to lock the legs in position when in use. Easy and secure.
Argolla autodeslizante para bloquear las patas en posición de uso. Fácil y seguro.
Anneau autoglissant pour blocage des pieds en position d'usage. Facile et sûr.
Selbstgleitender Metallschiebering zur Feststellung der aufgeklappten Tischbeine. Einfach und sicher.



XLtrolley available for 20 tables. See page 44.
Carro XLtrolley disponible para 20 mesas. Ver pág. 44.
Chariot XLtrolley disponible pour 20 tables. Voir page 44.
Wagen XLtrolley lieferbar für 20 Tische. Siehe S.44.

thetextilecollection

stretch

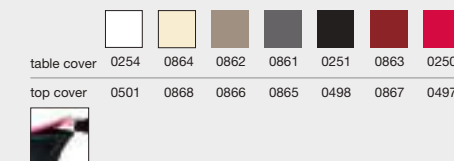

paramount

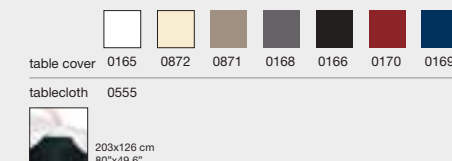

plain

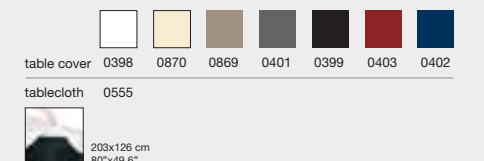

Code Código Code Code	EAN	Name Nombre Nom Name	Units per box Unidades por caja Unités par boîte Stückzahl pro Packung	Packaging size Medidas embalaje Dimensions emballage Verpackungsmaße	Packaging volume Volumen embalaje Volume d'emballage Verpackungsvolumen	Gross weight Peso bruto Poids brut Bruttogewicht	Loading quantity Unidades por contenedor Unités par conteneur Einheiten pro Container
BT-05BK	8437009886168	XL150	1	155.3 x 78 x 6.4 cm 61" x 30.7" x 2.4"	0.077 m ³ 2.719 ft ³	13.15 kg 28.93 lb	Container 40': 850 Container 40' HC: 940

XL180

TABLE MESA TABLE TISCH



Limited
10-year
warranty

Table with longitudinal joining system.
Mesa con sistema de unión longitudinal.
Table avec système de raccord longitudinal.
Tisch mit Längsverbindungssystem.

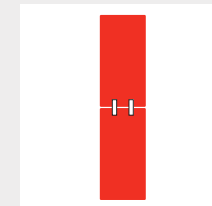

Longitudinal table joining system.
Sistema de unión longitudinal de mesas.
Système de raccord longitudinal de tables.
Vorrichtung zur längsseitigen Verbindung der Tische.

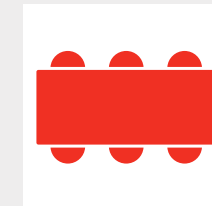

Capacity: 6 persons.
Area per person: 24".
Capacidad: 6 personas.
Espacio por persona: 61 cm.
Capacité: 6 personnes.
Espace par personne: 61 cm.
Bietet Platz für 6 Personen.
Platz pro Person: 61 cm.



Longitudinal table joining system.
Sistema de unión longitudinal de mesas.
Système de raccord longitudinal de tables.
Vorrichtung zur längsseitigen Verbindung der Tische.



Sliding ring to lock the legs in position when in use. Easy and secure.
Argolla autodeslizante para bloquear las patas en posición de uso. Fácil y seguro.
Anneau autoglissant pour blocage des pieds en position d'usage. Facile et sûr.
Selbststellender Metallschieber zur Feststellung der aufgeklappten Tischbeine. Einfach und sicher.



XLtrolley available for 20 tables. See page 44.
Carro XLtrolley disponible para 20 mesas. Ver pág. 44.
Chariot XLtrolley disponible pour 20 tables. Voir page 44.
Wagen XLtrolley lieferbar für 20 Tische. Siehe S.44.

H74.3 cm
H29.2"



L182.9 x W75.2 cm
L6' x W29.6"

45 mm

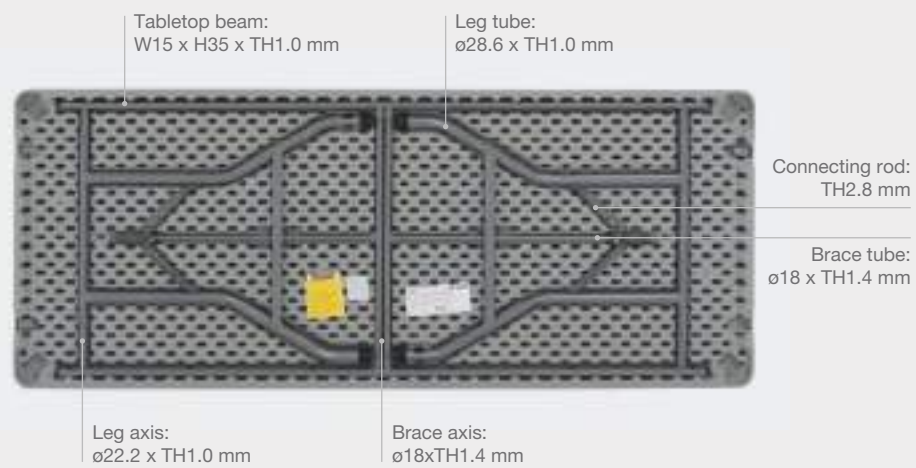

thetextilecollection

stretch

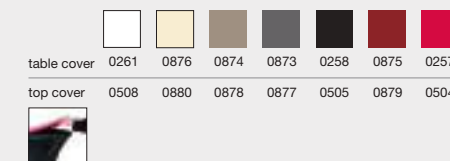

paramount

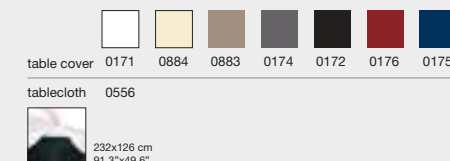

plain

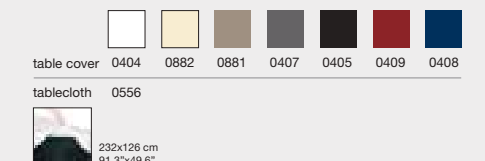



Code Código Code Code	EAN	Name Nombre Nom Name	Units per box Unidades por caja Unités par boîte Stückzahl pro Packung	Packaging size Medidas embalaje Dimensions emballage Verpackungsmaße	Packaging volume Volumen embalaje Volume d'emballage Verpackungsvolumen	Gross weight Peso bruto Poids brut Bruttogewicht	Loading quantity Unidades por contenedor Unités par conteneur Einheiten pro Container
BT-06BK	8437009886021	XL180	1	185.4 x 77 x 6.4 cm 73" x 30.6" x 2.5"	0.092 m ³ 3.248 ft ³	16 kg 35.2 lb	Container 40': 700 Container 40' HC: 800

worktop180

TABLE MESA TABLE TISCH

 **16.9 kg**
37.1 lb

 **270 kg**
595 lb

 Water-resistant

 HDPE Light Grey
 POWDER-COATED STEEL Grey

H74.3 / 85.1 / 90.2 / 94.3 cm
 H29.2" / 33.5" / 35.5" / 37.1"



L182.9 x W76.2 cm
 L6' x W30"

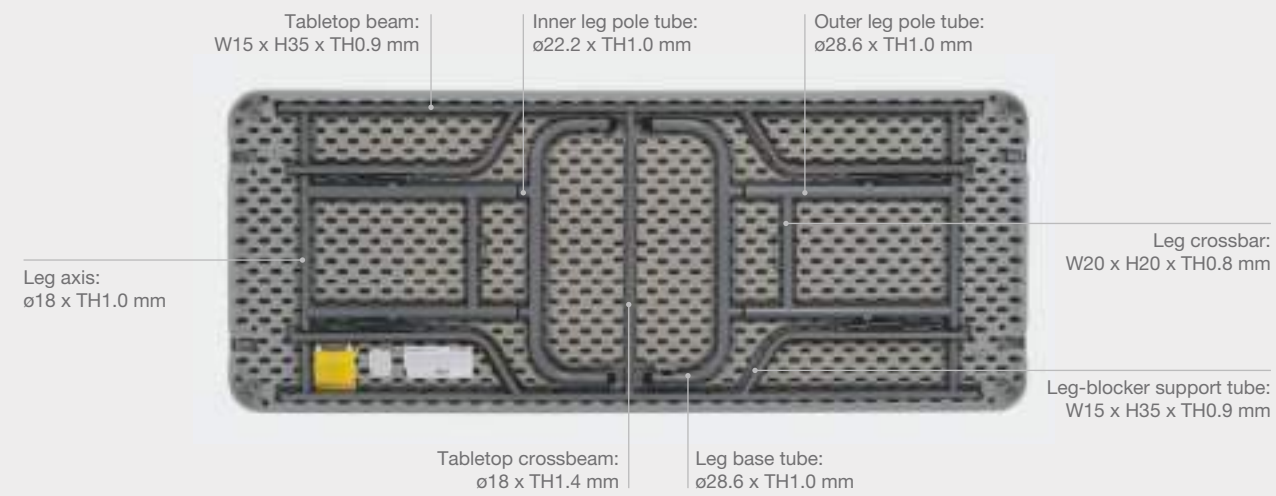

Foldable table height-adjustable in four positions. By selecting its higher positions, it is ideal as a work surface for performing tasks while standing. Mesa plegable de altura ajustable a 4 posiciones. Seleccionando sus posiciones más altas, resulta ideal como superficie de trabajo para tareas que se realicen estando de pie. Table pliable à hauteur réglable selon 4 positions. Les positions les plus hautes permettent de s'en servir comme plan de travail, idéal pour réaliser des tâches debout. Klapptisch, höhenverstellbar in 4 Positionen. Bei Einstellung einer der hohen Positionen ist der Tisch ideal als Arbeitsfläche für stehend ausgeführte Tätigkeiten.

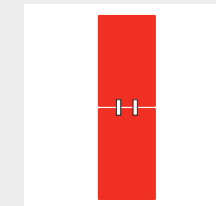

Longitudinal table joining system.
 Sistema de unión longitudinal de mesas.
 Système de raccord longitudinal de tables.
 Vorrichtung zur längsseitigen Verbindung der Tische.



Longitudinal table joining system.
 Sistema de unión longitudinal de mesas.
 Système de raccord longitudinal de tables.
 Vorrichtung zur längsseitigen Verbindung der Tische.

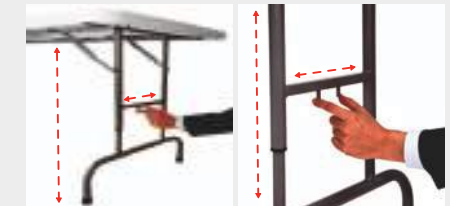

Practical mechanism for adjusting the table height.
 Práctico mecanismo para ajustar la altura de la mesa.
 Mécanisme pratique pour régler la hauteur de la table.
 Praktische Vorrichtung zum Einstellen der Tischhöhe.



Manual lock (1) and sliding ring (2) for greater leg stability when in use.
 Bloqueador manual (1) y argolla autodeslizante (2) para mayor seguridad de las patas en posición de uso.
 Blocage manuel (1) et anneau autoglissant (2) pour plus de sécurité des pieds en position d'usage.
 Manuelle Feststellung (1) und selbstgleitender Metallschieber (2) für eine höhere Sicherheit der Tischbeine in aufgeklappter Position.





XLtrolley available for 20 tables. See page 44.
 Carro XLtrolley disponible para 20 mesas. Ver pág. 44.
 Chariot XLtrolley disponible pour 20 tables. Voir page 44.
 Wagen XLtrolley lieferbar für 20 Tische. Siehe S. 44.



Ideal as a work surface.
 Ideal como superficie de trabajo.
 Idéal comme plan de travail.
 Ideal als Arbeitsfläche.

thetextilecollection

<p>stretch</p> 	<p>paramount</p> 	<p>plain</p> 
<p>table cover 0261 0876 0874 0873 0258 0875 0257</p> <p>top cover 0508 0880 0878 0877 0505 0879 0504</p>	<p>table cover 0171 0884 0883 0174 0172 0176 0175</p> <p>tablecloth 0556</p> <p>232x126 cm 91.3"x49.6"</p>	<p>table cover 0404 0882 0881 0407 0405 0409 0408</p> <p>tablecloth 0556</p> <p>232x126 cm 91.3"x49.6"</p>

Valid for the worktop180 table at a height of 74.3 cm/29.2" / Válido para mesa worktop180 en altura 74.3 cm/29.2" / Uniquement pour le table de hauteur 74.3 cm/29.2" / Gültig für Tisch worktop180 mit 74.3 cm/29.2" Höhe

Code Código Code Code	EAN	Name Nombre Nom Name	Units per box Unidades por caja Unités par boîte Stückzahl pro Packung	Packaging size Medidas embalaje Dimensions emballage Verpackungsmaße	Packaging volume Volumen embalaje Volume d'emballage Verpackungsvolumen	Gross weight Peso bruto Poids brut Bruttogewicht	Loading quantity Unidades por contenedor Unités par conteneur Einheiten pro Container
BT-06A-002	8437010781841	worktop180	1	185.4 x 77.8 x 6.4 cm 73" x 30.6" x 2.5"	0.092 m ³ 3.248 ft ³	19.5 kg 42.9 lb	Container 40: 700 Container 40' HC: 800

Table with wheels and bottom rack for storage. It can be turned into a buffet table by joining it to the "Top Shelf" model.
 Mesa con ruedas y estante inferior para almacenaje. Puede convertirse en una mesa buffet acoplándole un "Top Shelf".
 Table à roulettes avec une étagère de rangement dans la partie inférieure. Elle peut se transformer en table de buffet au moyen d'un « Top Shelf ».
 Tisch mit Rädern und Unterregal zur Ablage. Kann in Verbindung mit einem „Top Shelf“ in einen Büfett-Tisch verwandelt werden.

Upper shelf to be attached to the tables: XL180, Buffet base, Worktop180 to turn them into buffet tables.
 Estante superior para ser unido a las mesas: XL180, Buffet base, Worktop180 para convertirlas en una mesa-buffet.
 Étagère supérieure destinée à être reliée aux tables suivantes : XL180, Buffet base, Worktop180, pour en faire des tables de buffet.
 Oberregal zur Verbindung mit den Tischen XL180, Büfett-Basis und Worktop180 zur Umwandlung in einen Büfett-Tisch.

buffettablebase

TABLE MESA TABLE TISCH



19.15 kg
42.13 lb



150 kg
330 lb



Water-resistant



Limited
10-year
warranty

topshelf180

SHELF ESTANTE SHELF SHELF



7.2 kg
15.87 lb



70 kg
155 lb



Water-resistant



Ideal for displaying food in buffet services.
 Ideal para la disposición de alimentos en servicios de buffet.
 Idéal pour disposer différents plats lors d'un buffet.
 Ideal zum Anrichten von Speisen für Büfettts.



Ideal for use as a bar counter.
 Ideal para ser utilizado como mostrador de bar.
 Peut également être utilisée comme comptoir de bar.
 Ideal zur Verwendung als Bar-Theke.



4 wheels with integrated brakes.
 4 ruedas con freno incorporado.
 4 roulettes avec frein.
 4 Räder mit integrierter Bremse.



Upper shelf that can be attached to an Buffet table base, XL180table, Sharp180table and the Worktop180 in order to turn the regular table into a buffet-table.
 Estante superior para ser unido a las mesas Buffet table base, XL180, Sharp180 y Worktop180 para convertirla en una mesa-buffet.
 Tablette supplémentaire avec système d'accroche pour monter les tables Buffet table base, XL180, Sharp180 et Worktop180 en buffet.
 Tischaufsatz für Tisch Buffet table base, XL180, Verwandelt den XL180, Sharp180 und Worktop180 Tischen in einen Büfettisch.



thetextilecollection

paramount



plain

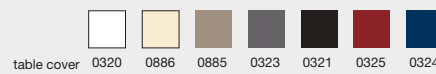

thetextilecollection

paramount

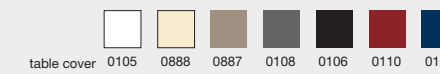

plain

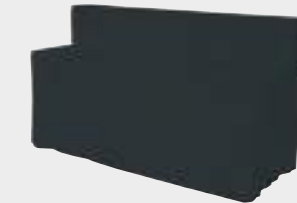

Code Código Code Code	EAN	Name Nombre Nom Name	Units per box Unidades por caja Unités par boîte Stückzahl pro Packung	Packaging size Medidas embalaje Dimensions emballage Verpackungsmaße	Packaging volume Volumen embalaje Volume d'emballage Verpackungsvolumen	Gross weight Peso bruto Poids brut Bruttogewicht	Loading quantity Unidades por contenedor Unités par conteneur Einheiten pro Container
PT010X002	8436539297413	buffettablebase	1	192.7 x 77.4 x 8.5 cm 75.8" x 30.5" x 3.3"	0.128 m ³ 4.520 ft ³	21.99 kg 48.38 lb	Container 40': 468 Container 40' HC: 520

Code Código Code Code	EAN	Name Nombre Nom Name	Units per box Unidades por caja Unités par boîte Stückzahl pro Packung	Packaging size Medidas embalaje Dimensions emballage Verpackungsmaße	Packaging volume Volumen embalaje Volume d'emballage Verpackungsvolumen	Gross weight Peso bruto Poids brut Bruttogewicht	Loading quantity Unidades por contenedor Unités par conteneur Einheiten pro Container
PT-26	8436539292470	topshelf180	1	197 x 32 x 6 cm 77.5" x 12.75" x 2.4"	0.037 m ³ 1.334 ft ³	8.5 kg 18.73 lb	Container 40': 1612 Container 40' HC: 1792

XL240

TABLE MESA TABLE TISCH

Table for eight diners.
Mesa para ocho comensales.
Table conçue pour huit personnes.
Tisch für acht Personen.



Limited
10-year
warranty

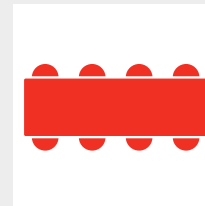

Capacity: 8 persons.
Area per person: 24".
Capacidad: 8 personas.
Espacio por persona: 61 cm.
Capacité: 8 personnes.
Espace par personne: 61 cm.
Bietet Platz für 8 Personen.
Platz pro Person: 61 cm.

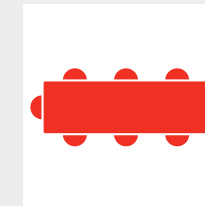

Capacity: 8 persons.
Area per person: 24".
Capacidad: 8 personas.
Espacio por persona: 61 cm.
Capacité: 8 personnes.
Espace par personne: 61 cm.
Bietet Platz für 8 Personen.
Platz pro Person: 61 cm.



L243.8 x W76.2 cm
L8' x W30"



Sliding ring to lock the legs in position when in use. Easy and secure.
Argolla autodeslizante para bloquear las patas en posición de uso. Fácil y seguro.
Anneau autogissant pour blocage des pieds en position d'usage. Facile et sûr.
Selbstgleitender Metallschiebering zur Feststellung der aufgeklappten Tischbeine. Einfach und sicher.



XLtrolley available for 18 tables. See page 44.
Carro XLtrolley disponible para 18 mesas. Ver pág. 44.
Chariot XLtrolley disponible pour 18 tables. Voir page 44.
Wagen XLtrolley lieferbar für 18 Tische. Siehe S.44.

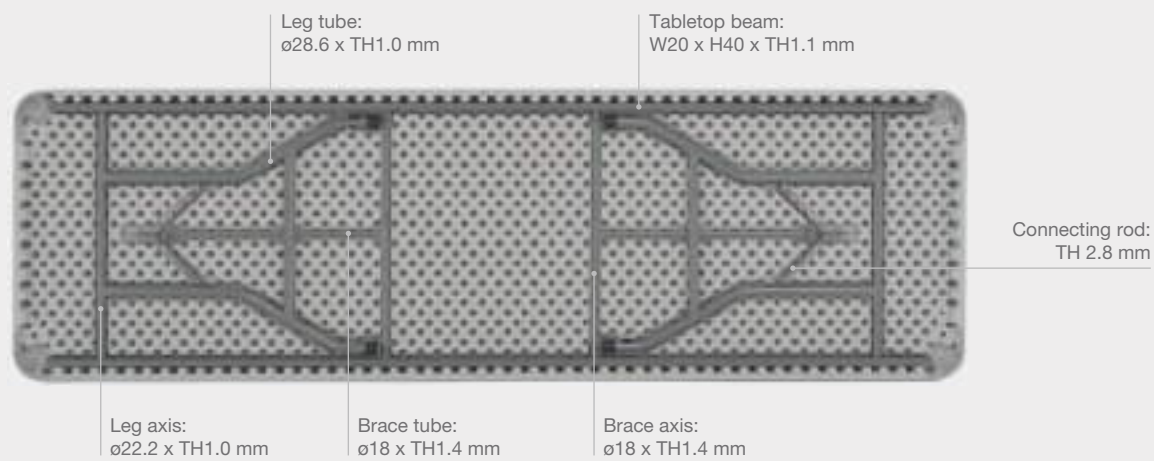

thetextilecollection

stretch



paramount



plain



Code Código Code Code	EAN	Name Nombre Nom Name	Units per box Unidades por caja Unités par boîte Stückzahl pro Packung	Packaging size Medidas embalaje Dimensions emballage Verpackungsmaße	Packaging volume Volumen embalaje Volume d'emballage Verpackungsvolumen	Gross weight Peso bruto Poids brut Bruttogewicht	Loading quantity Unidades por contenedor Unités par conteneur Einheiten pro Container
BT-08B	8437009886175	XL240	1	247.3 x 78 x 7.1 cm 97.4" x 30.6" x 2.8"	0.138 m ³ 4.873 ft ³	22 kg 48.4 lb	Container 40': 384 Container 40' HC: 540

table cover	0268	0892	0890	0889	0265	0891	0264
top cover	0515	0896	0894	0893	0512	0895	0511

table cover	0177	0900	0899	0180	0178	0182	0181
tablecloth	0557	294x126 cm 115.75"x49.6"					

table cover	0410	0898	0897	0413	0411	0415	0414
tablecloth	0557	294x126 cm 115.75"x49.6"					

Folding trolley with extendable base. Suitable for the XL150, XL180, XL240 and Worktop180 tables.
 Carro plegable con base extensible. Apto para las mesas XL150, XL180, XL240, Worktop180.
 Chariot pliant avec une base extensible. Compatible avec les tables XL150, XL180, XL240 et Worktop180.
 Klappwagen mit ausziehbarer Ladefläche. Geeignet für die Tische XL150, XL180, XL240, Worktop180.

XLtrolley

TROLLEY CARRO CHARIOT WAGEN



29.58 kg
65.22 lb



H115 cm
H45.3"



L(193 + 61) x W77 cm
L(76" + 24") x W30.3"



Peripheral posts to hold the stacked tables in place.

Postes périphériques pour immobiliser les tables empilées.

Poteaux périmétraux pour immobiliser les tables empilées.

Sicherungsstangen verhindern das Verrutschen der gestapelten Tische.

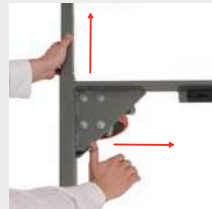

Expandable base to adjust to the respective table lengths.

Base extensible para adecuarla a la longitud de las distintas mesas.

Base extensible pour une adaptation à la longueur des différentes tables.

Die ausziehbare Ladefläche lässt sich an die jeweilige Tischlänge anpassen.



Handle specially designed to protect the hands.

Asa especial para proteger las manos.

Anse spécialement conçue pour protéger les mains.

Ein spezieller Griff schützt die Hände.



Four polyurethane wheels with built-in brake. (Two fixed wheels and two pivoting wheels).

4 ruedas de poliuretano con freno incorporado (2 ruedas fijas y 2 ruedas pivotantes).

4 roulettes en polyuréthane avec frein intégré. (2 roulettes fixes et 2 roulettes pivotantes).

4 PU-Räder mit integrierter Bremse. (2 feststehende Räder und 2 Schwenkräder).



Capacity: 20 pcs. XL150, 20 pcs. XL180, 20 pcs. worktop180, 18 pcs. XL240.

Capacidad: 20u. XL150, 20u. XL180, 20 pcs. worktop180, 18u. XL240.

Capacité: 20u. XL150, 20u. XL180, 20 pcs. worktop180, 18u. XL240.

Fassungsvermögen: 20 Stk. XL150, 20 Stk. XL180, 20 Stk. worktop180, 18 Stk. XL240.



Part to hold the removable posts when folded. Bar with automatic unlocking mechanism which allows the vertical bracket to be folded. Trolley in fully folded position. Occupies a minimum of space. All parts are integrated to prevent loss.

Pieza para sujetar los postes extraíbles en posición de plegado. Barra con mecanismo automático para desbloquear y permitir el plegado del soporte vertical. Carro totalmente plegado. Ocupa mínimo espacio y todos sus componentes quedan integrados para no extraviarlos.

Pièce pour les poteaux extractibles en position de pliage. Barre avec mécanisme automatique pour blocage et déblocage et pour permettre le pliage du support vertical. Chariot entièrement plié. Occupe peu de place. Tous ses composants sont intégrés pour ne pas les perdre.

Haltevorrichtung für die herausnehmbaren Stangen in abgeklappter Position. Stange mit automatischem Mechanismus zum Entriegeln und Zusammenklappen des senkrechten Gestells. Der Wagen lässt sich vollständig zusammenklappen. Platzsparend sind alle Bestandteile integriert, damit sie nicht verloren gehen.



Code Código Code Code	EAN	Name Nombre Nom Name	Units per box Unidades por caja Unités par boîte Stückzahl pro Packung	Packaging size Medidas embalaje Dimensions emballage Verpackungsmaße	Packaging volume Volumen embalaje Volume d'emballage Verpackungsvolumen	Gross weight Peso bruto Poids brut Bruttogewicht	Loading quantity Unidades por contenedor Unités par conteneur Einheiten pro Container
RA-102A	8437009886038	XLtrolley	1	198.1 x 87 x 15.2 cm 78" x 34.2" x 6"	0.262 m ³ 9.252 ft ³	35.35 kg 77.95 lb	Container 40': 229 Container 40' HC: 255

XLmoon

TABLE MESA TABLE TISCH

3-4
 18.6 kg / 41 lb
 300 kg / 661 lb
 Water-resistant

Limited 10-year warranty

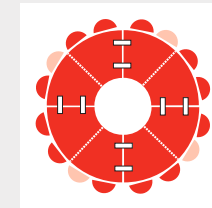
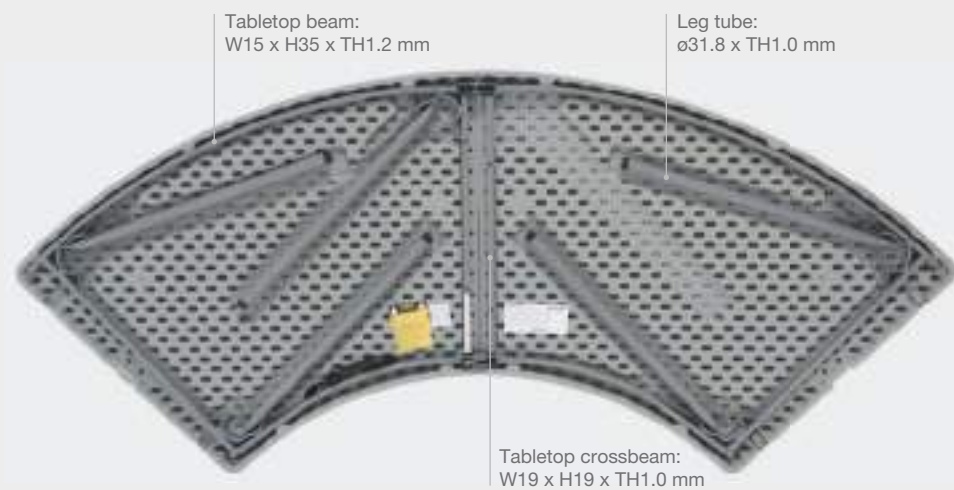

Circular joining of four XLmoon tables with 1 planet180 table. Capacity for 12 to 16 persons.

Unión circular de 4 mesas XLmoon con 1 mesa planet180. Capacidad 12 a 16 personas.

Raccord circulaire de 4 tables XLmoon avec 1 table planet180. Capacité 12 à 16 personnes.

Kreisförmige Verbindung von 4 Tischen XLmoon mit einem Tisch planet180. Bietet Platz für 12 bis 16 Personen.

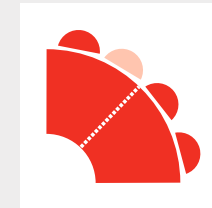

Capacity: 3 or 4 persons. Area per person: 34" or 25".

Capacidad: 3 o 4 personas. Espacio por persona: 87 o 65 cm.

Capacité: 3 ou 4 personnes. Espace par personne: 87 ou 65 cm.

Bietet Platz für 3 oder 4 Personen. Platz pro Person: 87 oder 65 cm.



Angular or circular table joining system.

Sistema de unión angular o circular de mesas.

Système de raccord d'angle ou raccord circulaire de tables.

Vorrichtung zur winkel- und kreisförmigen Verbindung von Tischen.



Automatic leg lock when in use.

Bloqueador automático de patas en posición de uso.

Blocage automatique des pieds en position d'usage.

Automatische Feststellung der aufgeklappten Tischbeine.



Height adjusters on 5 legs.

Regulador de altura en las 5 patas.

Régulateur de hauteur sur les 5 pieds.

Integrierte Höhenverstellung in den 5 Tischbeinen.



Folding table top. Table provided with carrying handle.

Sobre plegable. Mesa provista de un asa.

Surface pliable. Table munie d'une anse.

Der zusammengeklappte Tisch hat einen Tragegriff.

the textile collection

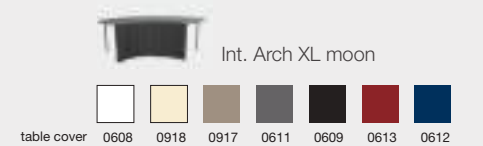
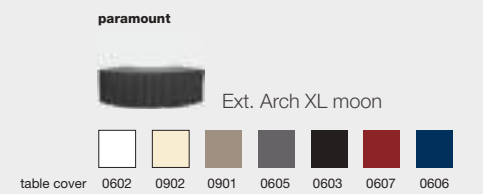
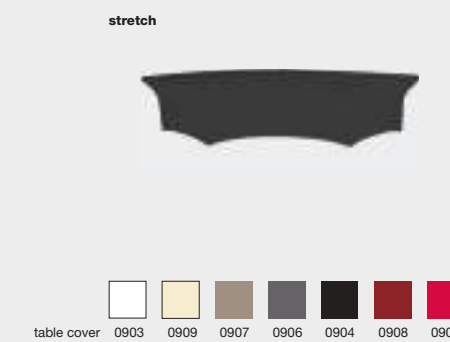

Includes self-adhesive velcro to hold the skirt in place. Incluye velcro auto-adhesivo para sujetar el faldón. Fourni avec ruban auto-agrippant velcro pour fixer le jupon de table. Mit selbstklebendem Klettband zur Befestigung des Tischvorhangs.

Code Código Code Code	EAN	Name Nombre Nom Name	Units per box Unidades por caja Unités par boîte Stückzahl pro Packung	Packaging size Medidas embalaje Dimensions emballage Verpackungsmaße	Packaging volume Volumen embalaje Volume d'emballage Verpackungsvolumen	Gross weight Peso bruto Poids brut Bruttogewicht	Loading quantity Unidades por contenedor Unités par conteneur Einheiten pro Container
PT-34	8437009886182	XLmoon	1	129.8 x 84.6 x 12 cm 51.1" x 33.3" x 4.7"	0.132 m ³ 4.661 ft ³	20.1 kg 44.22 lb	Container 40': 460 Container 40' HC: 520

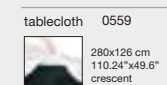
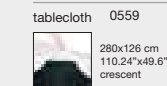

tablecloth 0559
280x126 cm
110.24"x49.6"
crescent

XLcorner

TABLE MESA TABLE TISCH

1
 6.6 kg / 14.4 lb
 100 kg / 220 lb
 Water-resistant

Limited
10-year
warranty

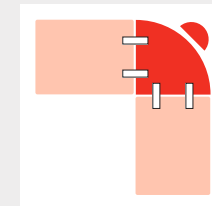

Capacity: 1 person.
Area per person: 47".

Capacidad: 1 persona.
Espacio por persona: 119.4 cm.

Capacité: 1 personne.
Espace par personne: 119.4 cm.

Bietet Platz für 1 Person.
Platz pro Person: 119.4 cm.



Angular table joining system.
Sistema de unión angular de mesas.
Système de raccord d'angle de tables.
Vorrichtung zur winkelförmigen Verbindung von Tischen.



Automatic leg lock when in use.
Bloqueador automático de patas en posición de uso.
Blocage automatique des pieds en position d'usage.
Automatische Feststellung der aufgeklappten Tischbeine.



Height adjuster on 3 legs.
Regulador de altura incorporado en las 3 patas.
Régulateur de hauteur intégré aux 3 pieds.
Integrierte Höhenverstellung in den 3 Tischbeinen.



Telescopic leg for optimal folding.
Una pata telescópica para permitir un óptimo plegado.
Pied télescopique permettant un pliage optimal.
Ein zusammenschiebbares Tischbein ermöglicht ein optimales Zusammenklappen.

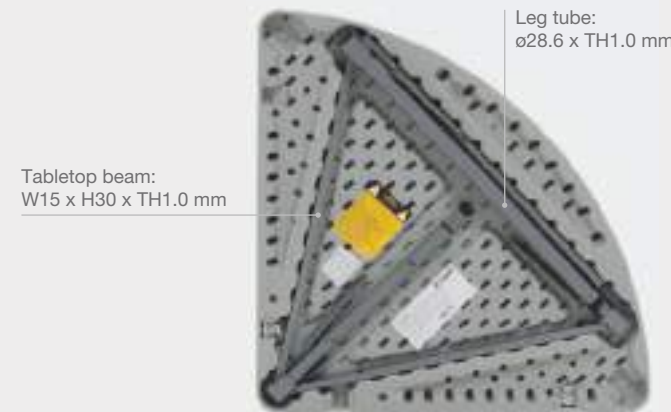

the textile collection

stretch **plain** **paramount**

tablecloth 0558
 125x125 cm / 49.25" x 49.25" / quarter round
 Includes self-adhesive velcro to hold the skirt in place / Incluye velcro auto-adhesivo para sujetar el faldo / Fourni avec ruban auto-agrippant velcro pour fixer le jupon de table / Mit selbstklebendem Klettband zur Befestigung des Tischvorhangs

tablecloth 0558
 125x125 cm / 49.25" x 49.25" / quarter round

Ext. Arch XL corner

Code Código Code Code	EAN	Name Nombre Nom Name	Units per box Unidades por caja Unités par boîte Stückzahl pro Packung	Packaging size Medidas embalaje Dimensions emballage Verpackungsmaße	Packaging volume Volumen embalaje Volume d'emballage Verpackungsvolumen	Gross weight Peso bruto Poids brut Bruttogewicht	Loading quantity Unidades por contenedor Unités par conteneur Einheiten pro Container
PT-32	8437009886045	XLcorner	2	78.1 x 76.8 x 14 cm 30.7" x 30.2" x 5.5"	0.083 m ³ 2.931 ft ³	14.6 kg 32.18 lb	Container 40': 1456 Container 40' HC: 1640

Square table with ergonomic legs.
 Mesa cuadrada con patas ergonómicas.
 Table carrée avec pieds ergonomiques.
 Quadratischer Tisch mit ergonomischen Füßen.

XXL90

TABLE MESA TABLE TISCH



Limited
10-year
warranty

H74.3 cm
H29.2"



L91.4 x W91.4 cm
L36" x W36"

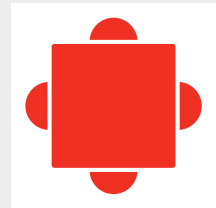

Capacity: 4 persons.
Area per person: 24".
Capacidad: 4 personas.
Espacio por persona: 61 cm.
Capacité: 4 personnes.
Espace par personne: 61 cm.
Bietet Platz für 4 Personen.
Platz pro Person: 61 cm.



Ergonomic crosspieces for greater comfort.
Travesaños ergonómicos para un mayor confort.
Traverse ergonomiques pour plus de confort.
Ergonomische Querstrebe für mehr Bequemlichkeit.



Manual lock (1) and sliding ring (2) for greater leg stability when in use.
Bloqueador manual (1) y argolla autodeslizante (2) para mayor seguridad de las patas en posición de uso.
Blocage manuel (1) et anneau autoglissant (2) pour plus de sécurité des pieds en position d'usage.
Manuelle Feststellung (1) und selbstgleitender Metallschieber (2) für eine höhere Sicherheit der Tischbeine in aufgeklappter Position.



XXLtrolley available for 28 tables (2 stacks of 14 tables). See page 58.
Carro XXLtrolley disponible para 28 mesas (2 pilas de 14 mesas). Ver pág. 58.
Chariot XXLtrolley disponible pour 28 tables (2 piles de 14 tables). Voir page 58.
Wagen XXLtrolley für 28 Tische. (2 Stapel mit jeweils 14 Tischen). Siehe S.58.

the textile collection

stretch



table cover 0289 0938 0936 0935 0286 0937 0285
top cover 0536 0942 0940 0939 0533 0941 0532

paramount



table cover 0195 0946 0945 0198 0196 0200 0199
tablecloth 0562

142x142 cm
56" x 56"

plain



table cover 0428 0944 0943 0431 0429 0433 0432
tablecloth 0562

142x142 cm
56" x 56"

Code Código Code Code	EAN	Name Nombre Nom Name	Units per box Unidades por caja Unités par boîte Stückzahl pro Packung	Packaging size Medidas embalaje Dimensions emballage Verpackungsmaße	Packaging volume Volumen embalaje Volume d'emballage Verpackungsvolumen	Gross weight Peso bruto Poids brut Bruttogewicht	Loading quantity Unidades por contenedor Unités par conteneur Einheiten pro Container
BT-36	8437009886199	XXL90	1	93.4 x 94 x 6.4 cm 36.7" x 37" x 2.5"	0.056 m ³ 1.977 ft ³	11.8 kg 25.96 lb	Container 40': 1076 Container 40' HC: 1204



XXL200

TABLE MESA TABLE TISCH

Rectangular table with extra depth for greater comfort and longitudinal joining system.
Mesa rectangular con profundidad extra para mayor confort y con sistema de unión longitudinal.
Table rectangulaire plus large pour un plus grand confort, avec un système de raccord longitudinal.
Extra tiefer, rechteckiger Tisch für höheren Komfort, mit Längsverbindingssystem.



Limited
10-year
warranty



L198.2 x W91.4 cm
L6.5' x W36''

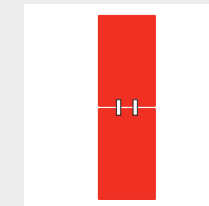
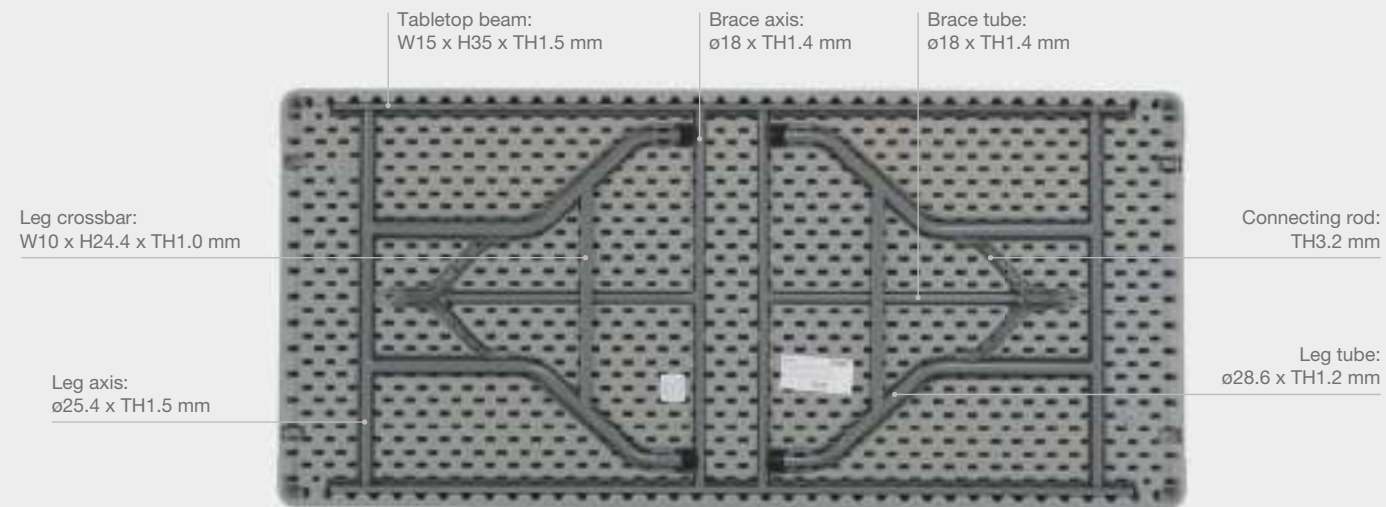

Longitudinal table joining system.
Sistema de unión longitudinal de mesas.
Système de raccord longitudinal de tables.
Vorrichtung zur längseitigen Verbindung der Tische.

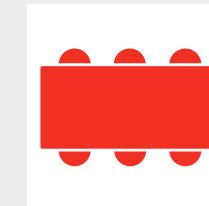

Capacity: 6 persons.
Area per person: 26".
Capacidad: 6 personas.
Espacio por persona: 66 cm.
Capacité: 6 personnes.
Espace par personne: 66 cm.
Bietet Platz für 6 Personen.
Platz pro Person: 66 cm.

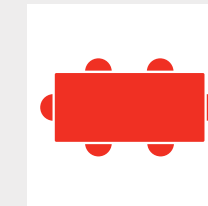

Capacity: 6 persons.
Area per person: 27".
Capacidad: 6 personas.
Espacio por persona: 69 cm.
Capacité: 6 personnes.
Espace par personne: 69 cm.
Bietet Platz für 6 Personen.
Platz pro Person: 69 cm.



Longitudinal table joining system.
Sistema de unión longitudinal de mesas.
Système de raccord longitudinal de tables.
Vorrichtung zur längseitigen Verbindung der Tische.



Sliding ring to lock the legs in position when in use. Easy and secure.
Argolla autodeslizante para bloquear las patas en posición de uso. Fácil y seguro.
Anneau autoglisant pour blocage des pieds en position d'usage. Facile et sûr.
Selbstgleitender Metallschieber zur Feststellung der aufgeklappten Tischbeine. Einfach und sicher.



XXLtrolley available for 18 tables. See page 58.
Carro XXLtrolley disponible para 18 mesas. Ver pág. 58.
Chariot XXLtrolley disponible pour 18 tables. Voir page 58.
Wagen XXLtrolley für 18 Tische lieferbar. Siehe S. 58.

the textile collection

stretch



table cover	0275	0950	0948	0947	0272	0949	0271
top cover	0522	0954	0952	0951	0519	0953	0518

paramount



table cover	0183	0958	0957	0186	0184	0188	0187
tablecloth	0560						
	248x142 cm 94.64"x56"						

plain



table cover	0416	0956	0955	0419	0417	0421	0420
tablecloth	0560						
	248x142 cm 94.64"x56"						

Code Código Code Code	EAN	Name Nombre Nom Name	Units per box Unidades por caja Unités par boîte Stückzahl pro Packung	Packaging size Medidas embalaje Dimensions emballage Verpackungsmaße	Packaging volume Volumen embalaje Volume d'emballage Verpackungsvolumen	Gross weight Peso bruto Poids brut Bruttogewicht	Loading quantity Unidades por contenedor Unités par conteneur Einheiten pro Container
PT-29	8437009886052	XXL200	1	200.7 x 93.7 x 6.4 cm 79" x 36.9" x 2.5"	0.120 m ³ 4.237 ft ³	23 kg 50.6 lb	Container 40': 516 Container 40' HC: 576

XXL240

TABLE MESA TABLE TISCH



Limited
10-year
warranty



L240 x W91.4 cm
L8' x W36''

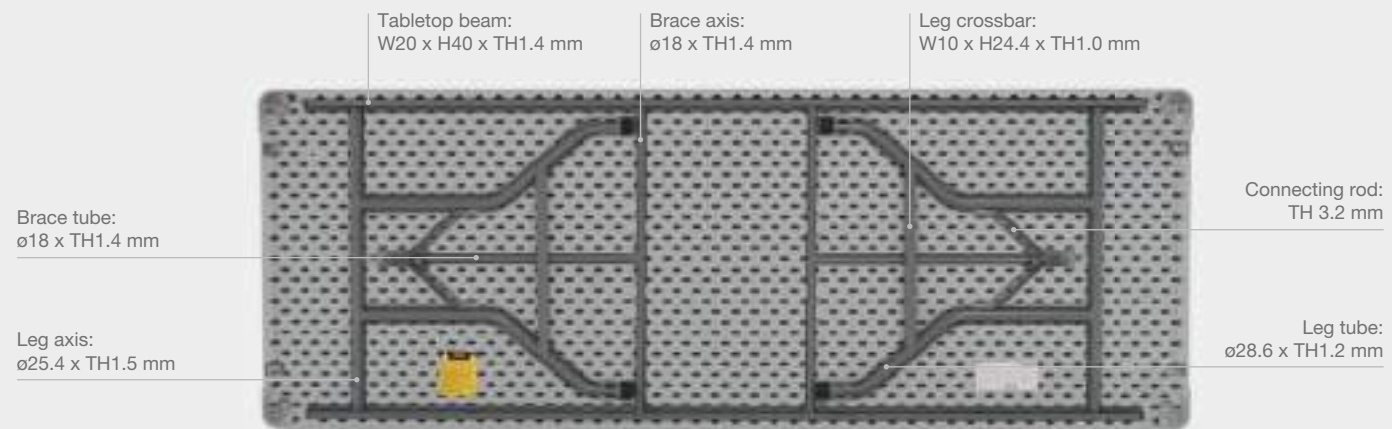

Rectangular table with extra depth for greater comfort and longitudinal joining system.
Mesa rectangular con profundidad extra para mayor confort y con sistema de unión longitudinal.
Table rectangulaire plus large pour un plus grand confort, avec un système de raccord longitudinal.
Extra tiefer, rechteckiger Tisch für höheren Komfort, mit Längsverbindingssystem.

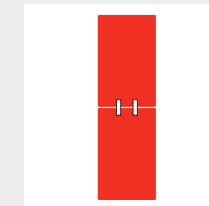

Longitudinal table joining system.
Sistema de unión longitudinal de mesas.
Système de raccord longitudinal de tables.
Vorrichtung zur längseitigen Verbindung der Tische.

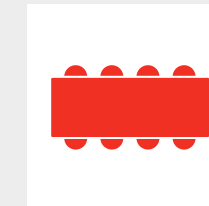

Capacity: 8 persons.
Area per person: 24''.
Capacidad: 8 personas.
Espacio por persona: 61 cm.
Capacité: 8 personnes.
Espace par personne: 61 cm.
Bietet Platz für 8 Personen.
Platz pro Person: 61 cm.

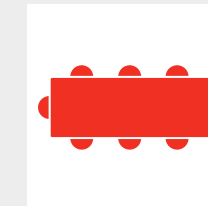

Capacity: 8 persons.
Area per person: 24''.
Capacidad: 8 personas.
Espacio por persona: 61 cm.
Capacité: 8 personnes.
Espace par personne: 61 cm.
Bietet Platz für 8 Personen.
Platz pro Person: 61 cm.



Longitudinal table joining system.
Sistema de unión longitudinal de mesas.
Système de raccord longitudinal de tables.
Vorrichtung zur längseitigen Verbindung der Tische.



Sliding ring to lock the legs in position when in use. Easy and secure.
Argolla autodeslizante para bloquear las patas en posición de uso. Fácil y seguro.
Anneau autoglisant pour blocage des pieds en position d'usage. Facile et sûr.
Selbstgleitender Metallschieber zur Feststellung der aufgeklappten Tischbeine. Einfach und sicher.



XXLtrolley available for 15 tables. See page 58.
Carro XXLtrolley disponible para 15 mesas. Ver pág. 58.
Chariot XXLtrolley disponible pour 15 tables. Voir page 58.
Wagen XXLtrolley für 15 Tische lieferbar. Siehe S. 58.

the textile collection

stretch



table cover 0282 0962 0960 0959 0279 0961 0278
top cover 0529 0966 0964 0963 0526 0965 0525



paramount



table cover 0189 0970 0969 0192 0190 0194 0193



290x142 cm
114.18"x56"

plain



table cover 0422 0968 0967 0425 0423 0427 0426



290x142 cm
114.18"x56"

Code Código Code Code	EAN	Name Nombre Nom Name	Units per box Unidades por caja Unités par boîte Stückzahl pro Packung	Packaging size Medidas embalaje Dimensions emballage Verpackungsmaße	Packaging volume Volumen embalaje Volume d'emballage Verpackungsvolumen	Gross weight Peso bruto Poids brut Bruttogewicht	Loading quantity Unidades por contenedor Unités par conteneur Einheiten pro Container
PT-31	8437009886205	XXL240	1	242.6 x 93.7 x 7 cm 95.5" x 36.9" x 2.7"	0.159 m ³ 5.615 ft ³	28.4 kg 62.48 lb	Container 40': 370 Container 40' HC: 440

XXLcorner

TABLE MESA TABLE TISCH

Table with angular joining system. It allows several configurations by combining it with rectangular "XXL" tables.
 Mesa con sistema de unión angular. Permite varias composiciones combinándola con mesas rectangulares "XXL".
 Table avec système de raccord d'angle. Elle permet différentes compositions avec des tables rectangulaires « XXL ».
 Tisch mit Eckverbindungssystem. Ermöglicht verschiedene Anordnungen durch Kombination mit den rechteckigen XXL-Tischen.



2



8 kg
17.6 lb



100 kg
220 lb



Water-resistant



HDPE
Light Grey
POWDER-COATED
STEEL
Grey

Limited
10-year
warranty

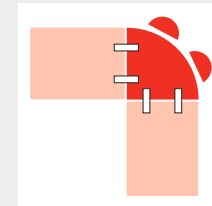

Capacity: 2 persons.
Area per person: 28".

Capacidad: 2 personas.
Espacio por persona: 71.5 cm.

Capacité: 2 personnes.
Espace par personne: 71.5 cm.

Bietet Platz für 2 Personen.
Platz pro Person: 71.5 cm.



Angular table joining system.
Sistema de unión angular de mesas.
Système de raccord d'angle de tables.
Vorrichtung zur winkelförmigen Verbindung von Tischen.



Automatic leg lock when in use.
Bloquedor automático de patas en posición de uso.
Blocage automatique des pieds en position d'usage.
Automatische Feststellung der aufgeklappten Tischbeine.



Height adjuster on 3 legs.
Regulador de altura incorporado en las 3 patas.
Régulateur de hauteur intégré aux 3 pieds.
Integrierte Höhenverstellung in den 3 Tischbeinen.



the textilecollection

stretch



plain



paramount



Ext. Arch XXL corner

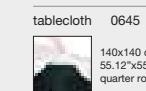
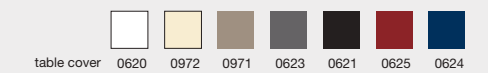
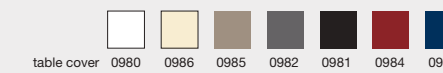

Code Código Code Code	EAN	Name Nombre Nom Name	Units per box Unidades por caja Unités par boîte Stückzahl pro Packung	Packaging size Medidas embalaje Dimensions emballage Verpackungsmaße	Packaging volume Volumen embalaje Volume d'emballage Verpackungsvolumen	Gross weight Peso bruto Poids brut Bruttogewicht	Loading quantity Unidades por contenedor Unités par conteneur Einheiten pro Container
PT-33	8437009886212	XXLcorner	1	93 x 94 x 6 cm 37" x 36.6" x 2.5"	0.052 m ³ 1.850 ft ³	9.8 kg 21.56 lb	Container 40': 1076 Container 40' HC: 1196

tablecloth	0645
140x140 cm 55.12"x55.12" quarter round	
Includes self-adhesive velcro to hold the skirt in place Incluye velcro auto-adhesivo para sujetar el faldón Fourni avec ruban auto-agrippant velcro pour fixer le jupon de table Mit selbstklebendem Klettband zur Befestigung des Tischvorhangs	
tablecloth	0645
140x140 cm 55.12"x55.12" quarter round	

Folding trolley with extendable base. Suitable for the **XXL90**, **XXL200**, **XXL240** and **M183** tables.
 Carro plegable con base extensible. Apto para las mesas **XXL90**, **XXL200**, **XXL240** y **M183**.
 Chariot pliant avec une base extensible. Compatible avec les tables **XXL90**, **XXL200**, **XXL240** et **M183**.
 Klappwagen mit ausziehbarer Ladefläche. Geeignet für die Tische **XXL90**, **XXL200**, **XXL240** und **M183**.

XXL trolley

TROLLEY CARRO CHARIOT WAGEN



31.4 kg
69.2 lb



H115 cm
H45.3"



L(202 + 46) x W92 cm
L(79.6" + 18.1") x W36.2"



Peripheral posts to hold the stacked tables in place.

Postes périphériques pour immobiliser les tables empilées.

Poteaux périmétraux pour immobiliser les tables empilées.

Sicherungsstangen verhindern das Verrutschen der gestapelten Tische.

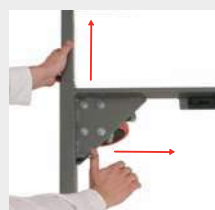

Expandable base to adjust to the respective table lengths.

Base extensible para adecuarla a la longitud de las distintas mesas.

Base extensible pour une adaptation à la longueur des différentes tables.

Die ausziehbare Ladefläche lässt sich an die jeweilige Tischlänge anpassen.



Special handle designed to protect the hands.

Asa especial para proteger las manos.

Anse spécialement conçue pour protéger les mains.

Ein spezieller Griff schützt die Hände.



Four polyurethane wheels with built-in brake. (Two fixed wheels and two pivoting wheels).

4 ruedas de poliuretano con freno incorporado (2 ruedas fijas y 2 ruedas pivotantes).

4 roulettes en polyuréthane avec frein intégré. (2 roulettes fixes et 2 roulettes pivotantes).

4 PU-Räder mit integrierter Bremse. (2 feststehende Räder und 2 Schwenkräder).



Capacity: 28 pcs. **XXL90**, 18 pcs. **XXL200**, 15 pcs. **XXL240**, 24 pcs. **M183**.

Capacidad: 28u. **XXL90**, 18u. **XXL200**, 15u. **XXL240**, 24u. **M183**.

Capacité : 28u. **XXL90**, 18u. **XXL200**, 15u. **XXL240**, 24u. **M183**.

Fassungsvermögen: 28 Stk. **XXL90**, 18 Stk. **XXL200**, 15 Stk. **XXL240**, 24 Stk. **M183**.

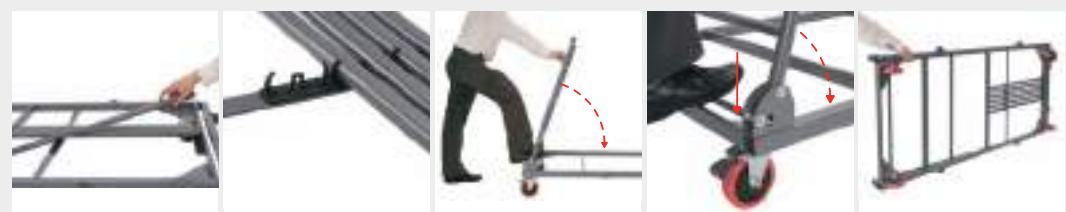

Part to hold the removable posts when folded. Bar with automatic unlocking mechanism which allows the vertical bracket to be folded. Trolley in fully folded position. Occupies a minimum of space. All parts are integrated to prevent loss.

Pieza para sujetar los postes extraíbles en posición de plegado. Barra con mecanismo automático para desbloquear y permitir el plegado del soporte vertical. Carro totalmente plegado. Ocupa mínimo espacio y todos sus componentes quedan integrados para no extraviarlos.

Pièce pour les poteaux extractibles en position de pliage. Barre avec mécanisme automatique pour blocage et déblocage et pour permettre le pliage du support vertical. Chariot entièrement plié. Occupe peu de place. Tous ses composants sont intégrés pour ne pas les perdre.

Haltevorrichtung für die herausnehmbaren Stangen in abgeklappter Position. Stange mit automatischem Mechanismus zum Entriegeln und Zusammenklappen des senkrechten Gestells. Der Wagen lässt sich vollständig zusammenklappen. Platzsparend sind alle Bestandteile integriert, damit sie nicht verloren gehen.



Code Código Code Code	EAN	Name Nombre Nom Name	Units per box Unidades por caja Unités par boîte Stückzahl pro Packung	Packaging size Medidas embalaje Dimensions emballage Verpackungsmaße	Packaging volume Volumen embalaje Volume d'emballage Verpackungsvolumen	Gross weight Peso bruto Poids brut Bruttogewicht	Loading quantity Unidades por contenedor Unités par conteneur Einheiten pro Container
RA-105A	8437009886069	XXL trolley	1	212.7 x 101.6 x 15.2 cm 83.7" x 40" x 6"	0.328 m ³ 11.583 ft ³	37.1 kg 81.6 lb	Container 40': 189 Container 40' HC: 210

XXLmoon

TABLE MESA TABLE TISCH



Limited
10-year
warranty

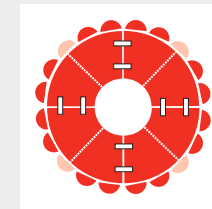

Circular joining of four XXLmoon tables with 1 planet180 table. Capacity for 16 to 20 persons.

Unión circular de 4 mesas XXLmoon con 1 mesa planet180. Capacidad 16 a 20 personas.

Raccord circulaire de 4 tables XXLmoon avec 1 table planet180. Capacité 16 à 20 personnes.

Kreisförmige Verbindung von 4 Tischen XXLmoon mit einem Tisch planet180. Bietet Platz für 16 bis 20 Personen.



Capacity: 4 or 5 persons. Area per person: 28" or 22.5".

Capacidad: 4 o 5 personas. Espacio por persona: 71 o 57 cm.

Capacité: 4 ou 5 personnes. Espace par personne: 71 ou 57 cm.

Bietet Platz für 4 oder 5 Personen. Platz pro Person: 71 oder 57 cm.



Angular or circular table joining system.

Sistema de unión angular o circular de mesas.

Système de raccord d'angle ou raccord circulaire de tables.

Vorrichtung zur winkel- und kreisförmigen Verbindung von Tischen.



Automatic leg lock when in use.

Bloqueador automático de patas en posición de uso.

Blocage automatique des pieds en position d'usage.

Automatische Feststellung der aufgeklappten Tischbeine.



Height adjusters on 5 legs.

Regulador de altura en las 5 patas.

Régulateur de hauteur sur les 5 pieds.

Integrierte Höhenverstellung in den 5 Tischbeinen.



Folding table top. Table provided with carrying handle.

Sobre plegable. Mesa provista de un asa.

Surface pliable. Table munie d'une anse.

Der zusammengeklappte Tisch hat einen Tragegriff.

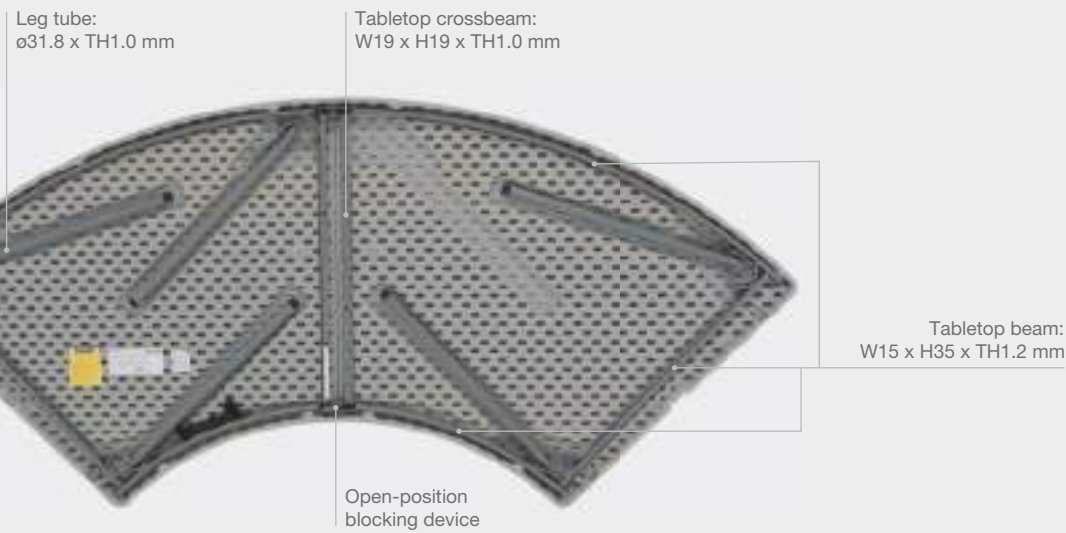

the textile collection

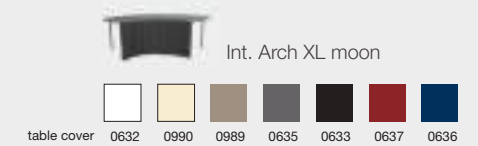

Code Código Code Code	EAN	Name Nombre Nom Name	Units per box Unidades por caja Unités par boîte Stückzahl pro Packung	Packaging size Medidas embalaje Dimensions emballage Verpackungsmaße	Packaging volume Volumen embalaje Volume d'emballage Verpackungsvolumen	Gross weight Peso bruto Poids brut Bruttogewicht	Loading quantity Unidades por contenedor Unités par conteneur Einheiten pro Container
PT-35	8437009886076	XXLmoon	1	142.2 x 101 x 12 cm 56" x 39.7" x 4.7"	0.172 m ³ 6.074 ft ³	24.7 kg 54.34 lb	Container 40': 344 Container 40' HC: 390

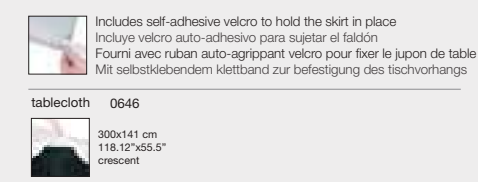



planet120

TABLE MESA TABLE TISCH

Round table for up to six diners.
Mesa redonda para hasta seis comensales.
Table ronde pour six personnes.
Runder Tisch für bis zu sechs Personen.



Limited
10-year
warranty

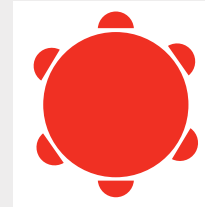

Capacity: 6 persons.
Area per person: 25".
Capacidad: 6 personas.
Espacio por persona: 64 cm.
Capacité: 6 personnes.
Espace par personne: 64 cm.
Bietet Platz für 6 Personen.
Platz pro Person: 64 cm.



ø122 cm
ø4'

H74.3 cm
H29.2"



Ergonomic crosspieces for greater comfort.
Travesaños ergonómicos para un mayor confort.
Traverses ergonomiques pour plus de confort.
Ergonomische Quertraverse für mehr Bequemlichkeit.



Manual lock (1) and sliding ring (2) for greater leg stability when in use.
Bloqueador manual (1) y argolla autodeslizante (2) para mayor seguridad de las patas en posición de uso.
Blocage manuel (1) et anneau autoglissant (2) pour plus de sécurité des pieds en position d'usage.
Manuelle Feststellung (1) und selbstgleitender Metallschieber (2) für eine höhere Sicherheit der Tischbeine in aufgeklappter Position.



Planetrolley available for 16 tables. See page 72.
Carro planetrolley disponible para 16 mesas. Ver pág. 72.
Chariot planetrolley disponible pour 16 tables. Voir page 72.
Wagen planetrolley lieferbar für 16 Tische. Siehe S.72.

thetextilecollection

stretch



paramount



plain

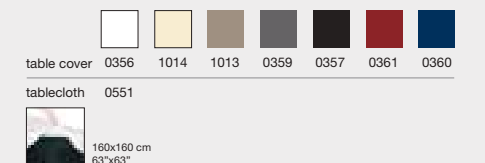
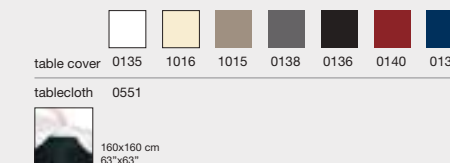
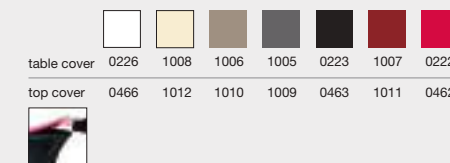

Code Código Code Code	EAN	Name Nombre Nom Name	Units per box Unidades por caja Unités par boîte Stückzahl pro Packung	Packaging size Medidas embalaje Dimensions emballage Verpackungsmaße	Packaging volume Volumen embalaje Volume d'emballage Verpackungsvolumen	Gross weight Peso bruto Poids brut Bruttogewicht	Loading quantity Unidades por contenedor Unités par conteneur Einheiten pro Container
BT-48B	8437009886229	planet120	1	124.5 x 124.5 x 6.4 cm 49" x 49" x 2.5"	0.099 m ³ 3.496 ft ³	14.4 kg 31.68 lb	Container 40': 505 Container 40' HC: 700

planet150

TABLE MESA TABLE TISCH

Round folding table for up to eight diners.
Mesa plegable redonda para hasta ocho comensales.
Table pliante ronde pour huit personnes.
Runder Klapp Tisch für bis zu acht Personen.



Limited 10 year warranty

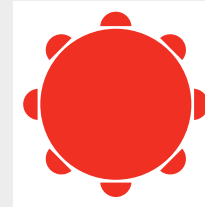

Capacity: 8 persons.
Area per person: 23.5".
Capacidad: 8 personas.
Espacio por persona: 59.7 cm.
Capacité: 8 personnes.
Espace par personne: 59.7 cm.
Bietet Platz für 8 Personen.
Platz pro Person: 59.7 cm.



H74.3 cm
H29.2"

50.8 mm

ø152.4 cm
ø5'



Ergonomic crosspieces for greater comfort.
Travesaños ergonómicos para un mayor confort.
Traverses ergonomiques pour plus de confort.
Ergonomische Quertraverse für mehr Bequemlichkeit.



Manual lock (1) and sliding ring (2) for greater leg stability when in use.
Bloqueador manual (1) y argolla auto-deslizante (2) para mayor seguridad de las patas en posición de uso.
Blocage manuel (1) et anneau autoglisant (2) pour plus de sécurité des pieds en position d'usage.
Manuelle Feststellung (1) und selbstgleitender Metallschieber (2) für eine höhere Sicherheit der Tischbeine in aufgeklappter Position.



Planetrolley available for 14 tables. See page 72.
Carro planetrolley disponible para 14 mesas. Ver pág. 72.
Chariot planetrolley disponible pour 14 tables. Voir page 72.
Wagen planetrolley lieferbar für 14 Tische. Siehe S.72.

thetextilecollection

stretch



paramount



plain

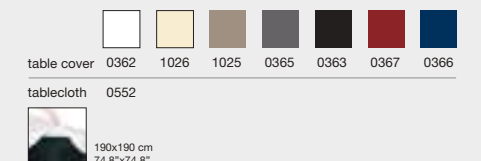
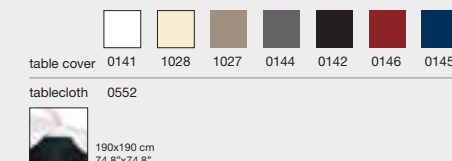
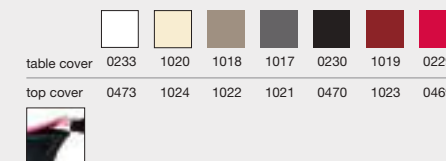

Code Código Code Code	EAN	Name Nombre Nom Name	Units per box Unidades por caja Unités par boîte Stückzahl pro Packung	Packaging size Medidas embalaje Dimensions emballage Verpackungsmaße	Packaging volume Volumen embalaje Volume d'emballage Verpackungsvolumen	Gross weight Peso bruto Poids brut Bruttogewicht	Loading quantity Unidades por contenedor Unités par conteneur Einheiten pro Container
BT-60B	8437009886083	planet150	1	154.9 x 154.9 x 7 cm 61" x 61" x 2.8"	0.168 m ³ 5.932 ft ³	21.86 kg 48.09 lb	Container 40': 320 Container 40' HC: 360

planet160

TABLE MESA TABLE TISCH

Round folding table for up to eight diners.
Mesa plegable redonda para hasta ocho comensales.
Table pliante ronde pour huit personnes.
Runder Klapp Tisch für bis zu acht Personen.



Limited
10-year
warranty

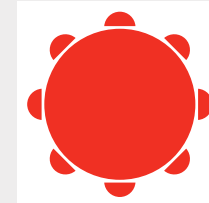

Capacity: 8 persons.
Area per person: 24.7".

Capacidad: 8 personas.
Espacio por persona: 62.8 cm.

Capacité: 8 personnes.
Espace par personne: 62.8 cm.

Bietet Platz für 8 Personen.
Platz pro Person: 62.8 cm.



H74.3 cm
H29.2"

50.8 mm

ø160 cm
ø63"

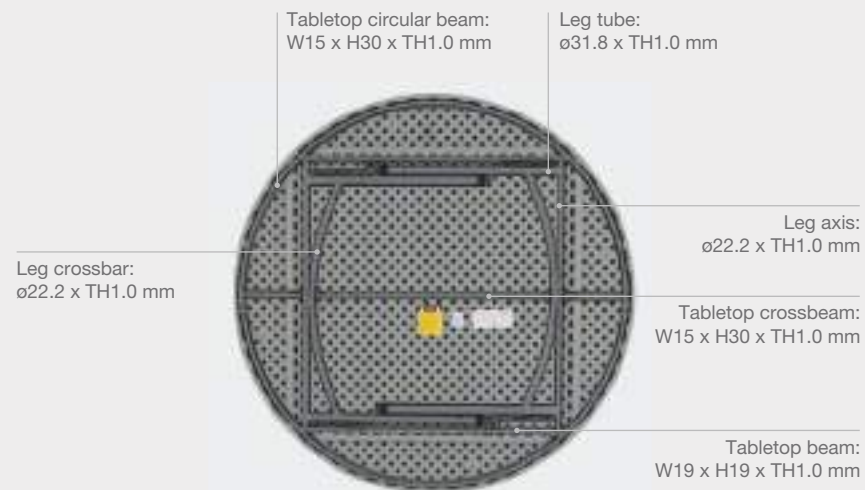

Ergonomic crosspieces for greater comfort.
Travesaños ergonómicos para un mayor confort.
Traverses ergonomiques pour plus de confort.
Ergonomische Quertraverse für mehr Bequemlichkeit.



Manual lock (1) and sliding ring (2) for greater leg stability when in use.
Bloqueador manual (1) y argolla autodeslizante (2) para mayor seguridad de las patas en posición de uso.
Blocage manuel (1) et anneau autoglissant (2) pour plus de sécurité des pieds en position d'usage.
Manuelle Feststellung (1) und selbstgleitender Metallschieber (2) für eine höhere Sicherheit der Tischbeine in aufgeklappter Position.



Planetrolley available for 14 tables. See page 72.
Carro planetrolley disponible para 14 mesas. Ver pág. 72.
Chariot planetrolley disponible pour 14 tables. Voir page 72.
Wagen planetrolley lieferbar für 14 Tische. Siehe S.72.

thetextilecollection

stretch



paramount



plain

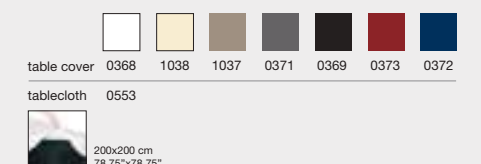
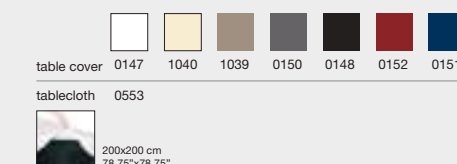
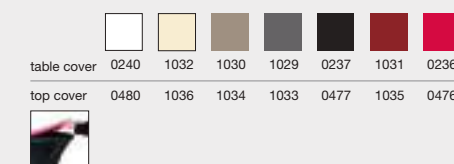

Code Código Code Code	EAN	Name Nombre Nom Name	Units per box Unidades por caja Unités par boîte Stückzahl pro Packung	Packaging size Medidas embalaje Dimensions emballage Verpackungsmaße	Packaging volume Volumen embalaje Volume d'emballage Verpackungsvolumen	Gross weight Peso bruto Poids brut Bruttogewicht	Loading quantity Unidades por contenedor Unités par conteneur Einheiten pro Container
BT-63	8437010781728	planet160	1	163.3 x 162.6 x 7 cm 64.3" x 64" x 2.8"	0.185 m ³ 6.547 ft ³	29.14 kg 64.11 lb	Container 40': 308 Container 40' HC: 336

planet180

TABLE MESA TABLE TISCH

10
29.3 kg
64.6 lb
350 kg
772 lb
 Water-resistant
 HOPE Light Gray
 POWDER-COATED STEEL Gray

Limited
10-year
warranty



H74.3 cm
H29.2"

55 mm

ø180.3 cm
ø5.92'

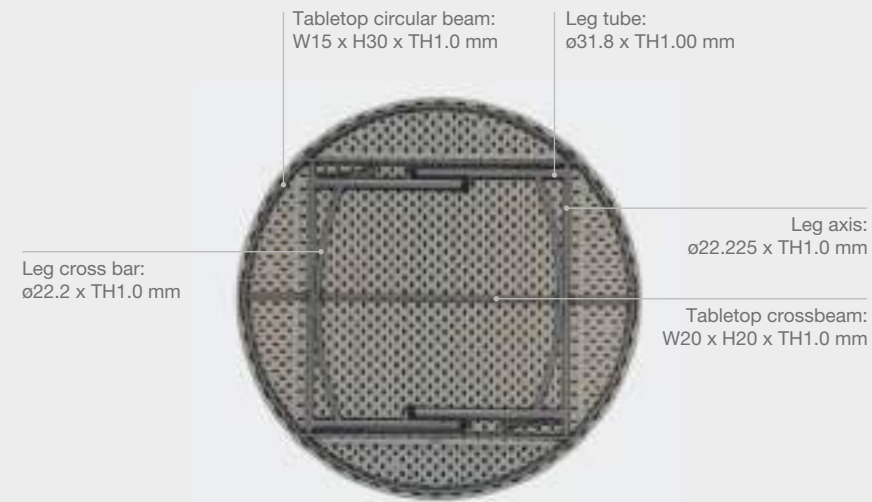

Round folding table for up to ten diners. The XLmoon or XXLmoon tables can be concentrically attached to make configurations for up to 20 diners. Mesa plegable redonda para hasta diez comensales. Se le pueden acoplar concéntricamente mesas XLmoon o XXLmoon para conseguir composiciones de hasta 20 comensales. Table pliante ronde pour dix personnes. Il est possible d'y ajouter des tables XLmoon ou XXLmoon pour créer des compositions pouvant accueillir jusqu'à 20 personnes. Runder Klappstisch für bis zu zehn Personen. Kann konzentrisch mit den Tischen XLmoon oder XXLmoon verbunden werden, um eine Anordnung für bis zu 20 Personen zu erzielen.

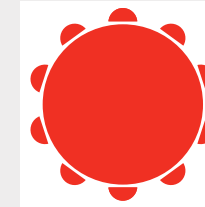

Capacity: 10 persons.
Area per person: 22.3".
Capacidad: 10 personas.
Espacio por persona: 56.6 cm.
Capacité: 10 personnes.
Espace par personne: 56.6 cm.
Bietet Platz für 10 Personen.
Platz pro Person: 56.6 cm.

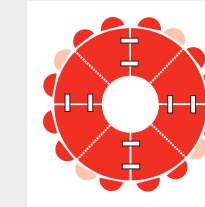

Circular joining of four XLmoon tables with 1 planet180 table. Capacity for 12 to 16 persons.
Unión circular de 4 mesas XLmoon con 1 mesa planet180. Capacidad 12 a 16 personas.
Raccord circulaire de 4 tables XLmoon avec 1 table planet180. Capacité 12 à 16 personnes.
Kreisförmige Verbindung von 4 Tischen XLmoon mit einem Tisch planet180. Bietet Platz für 12 bis 16 Personen.

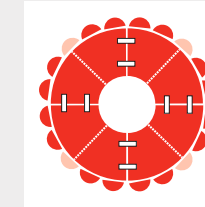

Circular joining of four XXLmoon tables with 1 planet180 table. Capacity for 16 to 20 persons.
Unión circular de 4 mesas XXLmoon con 1 mesa planet180. Capacidad 16 a 20 personas.
Raccord circulaire de 4 tables XXLmoon avec 1 table planet180. Capacité 16 à 20 personnes.
Kreisförmige Verbindung von 4 Tischen XXLmoon mit einem Tisch planet180. Bietet Platz für 16 bis 20 Personen.



Ergonomic crosspieces for greater comfort.
Travesaños ergonómicos para un mayor confort.
Traverses ergonomiques pour plus de confort.
Ergonomische Quertraverse für mehr Bequemlichkeit.



Manual lock (1) and sliding ring (2) for greater leg stability when in use.
Bloqueador manual (1) y argolla autodeslizante (2) para mayor seguridad de las patas en posición de uso.
Blocage manuel (1) et anneau autogissant (2) pour plus de sécurité des pieds en position d'usage.
Manuelle Feststellung (1) und selbstgleitender Metallschiebering (2) für eine höhere Sicherheit der Tischbeine in aufgeklappter Position.



Planetrolley available for 13 tables. See page 72.
Carro planetrolley disponible para 13 mesas. Ver pág. 72.
Chariot planetrolley disponible pour 13 tables. Voir page 72.
Wagen planetrolley lieferbar für 13 Tische. Siehe S.72.

thetextilecollection

stretch



table cover: 0247, 1044, 1042, 1041, 0244, 1043, 0243
 top cover: 0487, 1048, 1046, 1045, 0484, 1047, 0483

paramount



table cover: 0153, 1052, 1051, 0156, 0154, 0158, 0157
 tablecloth: 0554
 220x220 cm
 86.6" x 86.6"

plain



table cover: 0374, 1050, 1049, 0377, 0375, 0379, 0378
 tablecloth: 0554
 220x220 cm
 86.6" x 86.6"

Code Código Code Code	EAN	Name Nombre Nom Name	Units per box Unidades por caja Unités par boîte Stückzahl pro Packung	Packaging size Medidas embalaje Dimensions emballage Verpackungsmaße	Packaging volume Volumen embalaje Volume d'emballage Verpackungsvolumen	Gross weight Peso bruto Poids brut Bruttogewicht	Loading quantity Unidades por contenedor Unités par conteneur Einheiten pro Container
BT-71	8437009886236	planet180	1	183 x 183 x 7.3 cm 72" x 72" x 2.8"	0.243 m ³ 8.581 ft ³	33 kg 72.60 lb	Container 40': 241 Container 40' HC: 265

Trolley with extendable handle suitable for the planet120, planet150, planet160 and planet180 tables.
 Carro con asa extensible apto para las mesas planet120, planet150, planet160 y planet180.
 Chariot avec anse extensible, compatible avec les tables planet120, planet150, planet160 et planet180.
 Wagen mit ausziehbarem Griff, geeignet für die Tische planet120, planet150, planet160 und planet180.

planettrolley

TROLLEY CARRO CHARIOT WAGEN



30.8 kg
67.9 lb



H102 cm
H40.2"

L(132 + 30) x W83.2 cm
L(52" + 11.8") x W32.7"



Extendable handle.
Asa extensible.
Anse extensible.
Ausziehbarer Griff.



Four polyurethane wheels with built-in brake. (Two fixed wheels and two pivoting wheels).
4 ruedas de poliuretano con freno incorporado (2 ruedas fijas y 2 ruedas pivotantes).
4 roulettes en polyuréthane avec frein intégré. (2 roulettes fixes et 2 roulettes pivotantes).
4 PU-Räder mit integrierter Bremse. (2 feststehende Räder und 2 Schwenkräder).



Large loading platform.
Amplia plataforma de apoyo.
Large plateau de support.
Breite Ladefläche.



Polyester strap with tensioning mechanism to hold the tables in an upright position when the trolley is half loaded.
Correa de poliéster con tensor para mantener las mesas verticales si el carro está a media carga.
Courroie en polyester avec tendeur pour le maintien vertical des tables lorsque le chariot est à moitié plein.
Spannriemen aus Polyester zur Befestigung der senkrecht aufgestellten Tische, wenn der Wagen nur halbvoll ist.



Capacity: 16 pcs. Planet120, 14 pcs. Planet150, 14 pcs. Planet160, 13 pcs. Planet180.
Capacidad: 16u. Planet120, 14u. Planet150, 14u. Planet160, 13u. Planet180.
Capacité: 16u. Planet120, 14u. Planet150, 14u. Planet160, 13u. Planet180.
Fassungsvermögen: 16 Stk. Planet120, 14 Stk. Planet150, 14 Stk. Planet160, 13 Stk. Planet180.

Code Código Code Code	EAN	Name Nombre Nom Name	Units per box Unidades por caja Unités par boîte Stückzahl pro Packung	Packaging size Medidas embalaje Dimensions emballage Verpackungsmaße	Packaging volume Volumen embalaje Volume d'emballage Verpackungsvolumen	Gross weight Peso bruto Poids brut Bruttogewicht	Loading quantity Unidades por contenedor Unités par conteneur Einheiten pro Container
RA-106A	8437009886090	planet trolley	1	135.7 x 87.6 x 12.7 cm 53.5" x 34.5" x 5"	0.150 m ³ 5.297 ft ³	34.5 kg 75.9 lb	Container 40': 396 Container 40' HC: 460



cocktail80

TABLE MESA TABLE TISCH



8.9 kg
18 lb



170 kg
375 lb



Water-resistant



HDPE
Light Grey
POWDER-COATED
STEEL
Grey

Limited 10
year
warranty



U-shaped plate:
ø25.4 x TH1.0 mm

Tabletop crossbeam:
W10 x H20 x TH1.0 mm

Leg tube:
ø25.4 x TH1.0 mm

Tabletop beam:
W10 x H20 x TH1.0 mm

Open-position
blocking device

Leg crossbar:
ø19.1 x TH1.0 mm



High table with automatic leg locking mechanism.
Mesa alta con bloqueador automático de las patas.
Table haute avec système de blocage automatique des pieds.
Hoher Tisch mit automatischer Beinverriegelung.



Light and easy to fold and store.
Ligera y fácil de plegar y guardar.
Légère, facile à plier et à ranger.
Leicht und einfach zusammenzuklappen und zu verstauen.

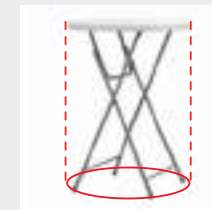

Large base which provides
great stability.
Base amplia que proporciona
gran estabilidad.
Base large qui confère une
grande stabilité.
Eine breite Standfläche sorgt
für eine ausgezeichnete
Standfestigkeit.



Manual lock for legs when in use.
Bloqueador de las patas en
posición de uso.
Blocage des pieds en position
d'utilisation.
Arretierung für Tischbeine in
aufgeklappter Position.



Cocktailtrolley available for 20
tables. See page 82.
Carro Cocktailtrolley disponible
para 20 mesas. Ver pág. 82.
Chariot Cocktailtrolley disponible
pour 20 tables.
Voir page 82. Wagen
Cocktailtrolley lieferbar für 20
Tische. Siehe S.82.

thetextilecollection

stretch



paramount



plain



Code Código Code Code	EAN	Name Nombre Nom Name	Units per box Unidades por caja Unités par boîte Stückzahl pro Packung	Packaging size Medidas embalaje Dimensions emballage Verpackungsmaße	Packaging volume Volumen embalaje Volume d'emballage Verpackungsvolumen	Gross weight Peso bruto Poids brut Bruttogewicht	Loading quantity Unidades por contenedor Unités par conteneur Einheiten pro Container
PT-36	8437009886243	cocktail80	1	141 x 82.9 x 7 cm 55.5" x 32.6" x 2.7"	0.082 m ³ 2.895 ft ³	10.85 kg 23.87 lb	Container 40': 750 Container 40' HC: 870

table cover	0296	1056	1054	1053	0293	1055	0292	0294	0295	0298	0297	table cover	0111	1064	1063	0114	0112	0116	0115	table cover	0326	1062	1061	0329	0327	0331	0330
top cover	0543	1060	1058	1057	0540	1059	0539	0541	0542	0545	0544	tablecloth	0547							tablecloth	0547						
													120x120 cm 47.25"x47.25"								120x120 cm 47.25"x47.25"						

Folding and lightweight high stool with backrest and wide seat.
 Taburete alto plegable y ligero con respaldo y amplio asiento.
 Tabouret haut pliant et léger, avec un dossier et une assise larges.
 Hoher, leichter Klapphocker mit Rückenlehne und breitem Sitz.

alvarstool

STOOL TABURETE TABOURET HOCKER



6.16 kg
13.55 lb



181 kg
400 lb



Water-resistant



POWDER-COATED STEEL Grey



Fold-down footrest to optimise folding.
 Reposapiés abatible para optimizar el plegado.
 Repose-pieds rabattable pour replier le tabouret de façon optimale.
 Klappbare Fußraste zum optimalen Zusammenklappen.



Spacious and comfortable seat.
 Asiento amplio y confortable.
 Siège large et confortable.
 Breiter und bequemer Sitz.



Easy to fold, transport and store.
 Fácil de plegar, transportar y guardar.
 Facile à plier, à transporter et à stocker.
 Einfach zusammenzuklappen, zu transportieren und aufzubewahren.

thetextilecollection

stretch



- stool cover 0033
- 1068
- 1066
- 1065
- 0030
- 1067
- 0029

classic



- stool cover 0074
- 1070
- 1069
- 0077
- 0075
- 0079
- 0078



Code Código Code Code	EAN	Name Nombre Nom Name	Units per box Unidades por caja Unités par boîte Stückzahl pro Packung	Packaging size Medidas embalaje Dimensions emballage Verpackungsmaße	Packaging volume Volumen embalaje Volume d'emballage Verpackungsvolumen	Gross weight Peso bruto Poids brut Bruttogewicht	Loading quantity Unidades por contenedor Unités par conteneur Einheiten pro Container
PC019X001A	8436539299509	alvarstool	2	140.65 x 53 x 18.4 cm 5.3" x 20.87" x 7.25"	0.137 m ³ 4.838 ft ³	14.38 kg 31.64 lb	Container 40': 856 Container 40' HC: 980



7.6 kg
16.8 lb



170 kg
375 lb



Water-resistant



HDPE
Light Grey
POWDER-COATED
STEEL
Grey

Limited
10-year
warranty



Large base which provides great stability.
Base amplia que proporciona gran estabilidad.
Base large qui confère une grande stabilité.
Eine breite Standfläche sorgt für eine ausgezeichnete Standfestigkeit.

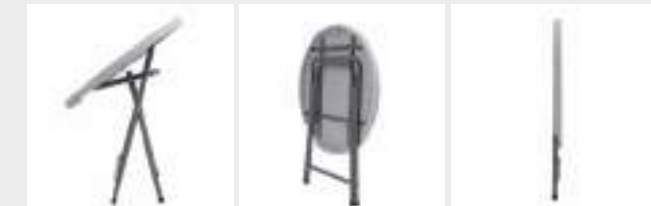

Light and easy to fold and store.
Ligera y fácil de plegar y guardar.
Légère, facile à plier et à ranger.
Leicht und einfach zusammenzuklappen und zu verstauen.



Cocktailtrolley available for 20 tables. See page 82.
Carro Cocktailtrolley disponible para 20 mesas. Ver pág. 82.
Chariot Cocktailtrolley disponible pour 20 tables.
Voir page 82. Wagen Cocktailtrolley lieferbar für 20 Tische. Siehe S.82.

U-shaped plate:
ø25.4 x TH1.0 mm

Tabletop crossbeam:
W10 x H20 x TH1.0 mm

Leg tube:
ø25.4 x TH1.0 mm



Tabletop beam:
W10 x H20 x TH1.0 mm

Open-position blocking device:
W10 x H20 x TH1.0 mm

Leg crossbar:
ø19.1 x TH1.0 mm

thetextilecollection

stretch



table cover	0303	1074	1072	1071	0300	1073	0299
top cover	0543	1060	1058	1057	0540	1059	0539

paramount



table cover	0159	1078	1077	0162	0160	0164	0163
tablecloth	0547						
	120x120 cm 47.25" x 47.25"						

plain



table cover	0380	1076	1075	0383	0381	0385	0384
tablecloth	0547						
	120x120 cm 47.25" x 47.25"						

Code Código Code Code	EAN	Name Nombre Nom Name	Units per box Unidades por caja Unités par boîte Stückzahl pro Packung	Packaging size Medidas embalaje Dimensions emballage Verpackungsmaße	Packaging volume Volumen embalaje Volume d'emballage Verpackungsvolumen	Gross weight Peso bruto Poids brut Bruttogewicht	Loading quantity Unidades por contenedor Unités par conteneur Einheiten pro Container
PT-37	8437009886106	praxis80	1	110.5 x 82.7 x 7 cm 43.5" x 33.6" x 2.7"	0.064 m ³ 2.260 ft ³	9 kg 20 lb	Container 40': 968 Container 40' HC: 1112

Multipurpose folding square table.
Mesa cuadrada plegable multiusos.
Table carrée pliable multi-usages.
Quadratischer Mehrzweck-Klapptisch.

bistrot70

TABLE MESA TABLE TISCH



2



6.17 kg
13.5 lb



225 kg
500 lb



Water-resistant



NEW



HDPE
White
POWDER-COATED
STEEL
White



HDPE
Dark Bronze
POWDER-COATED
STEEL
Dark Bronze

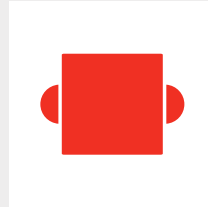

Capacity: 2 persons.
Area per person: 26".
Capacidad: 6 personas.
Espacio por persona: 66 cm.
Capacité: 6 personnes.
Espace par personne: 66 cm.
Bietet Platz für 6 Personen.
Platz pro Person: 66 cm.



Cocktailtrolley available for 20 tables. See page 82.
Carro cocktailtrolley disponible para 20 mesas. Ver pág. 82.
Chariot cocktailtrolley disponible pour 20 tables. Voir page 82.
Wagen cocktailtrolley lieferbar für 20 Tische. Siehe S.82.



Easy to fold, transport and store.
Fácil de plegar, transportar y guardar.
Facile à plier, à transporter et à stocker.
Einfach zusammenzuklappen, zu transportieren und aufzubewahren



Code Código Code Code	EAN	Name Nombre Nom Name	Units per box Unidades por caja Unités par boîte Stückzahl pro Packung	Packaging size Medidas embalaje Dimensions emballage Verpackungsmaße	Packaging volume Volumen embalaje Volume d'emballage Verpackungsvolumen	Gross weight Peso bruto Poids brut Bruttogewicht	Loading quantity Unidades por contenedor Unités par conteneur Einheiten pro Container
BT009X001A-W	8436539299653	bistrot70 white	1	70.20 x 6.03 x 102.9 cm 27.62" x 2.37" x 40.5"	0.044 m ³ 1.412 ft ³	7.67 kg 16.90 lb	Container 40': 1420 Container 40' HC: 1590
BT009X001A-DB	8436539299660	bistrot70 dark bronze					

Special trolley for transporting and storing the Cocktail80 and Praxis80 tables.
 Carro especial para el transporte y almacenaje de las mesas Cocktail80 y Praxis80.
 Chariot spécial pour le transport et le stockage des tables Cocktail80 et Praxis80.
 Spezieller Transport- und Lagerwagen für die Tische Cocktail80 und Praxis80.

cocktailtrolley

TROLLEY CARRO CHARIOT WAGEN



25.5 kg
56.2 lb



H101 cm
H39.6"

L121 x W89 cm
L47.6" x W35"



Base with 4° angle of inclination to keep the tables upright when loaded.

Base con 4° de inclinación para mantener las mesas verticales durante la carga.

Support d'une inclinaison de 4°, servant à tenir les tables à la verticale pendant le chargement.

Auflage mit 4° Neigung, um die Tische beim Laden senkrecht zu halten.



Grooved base to prevent the tables from slipping.

Base dentada para evitar que las mesas resbalen.

Support crénelé servant à empêcher que les tables ne glissent.

Gezackte Auflage, damit die Tische nicht verrutschen können.



Four polyurethane wheels with built-in brake. (Two fixed wheels and two pivoting wheels).

4 ruedas de poliuretano con freno incorporado (2 ruedas fijas y 2 ruedas pivotantes).

4 roulettes en polyuréthane avec frein intégré. (2 roulettes fixes et 2 roulettes pivotantes).

4 PU-Räder mit integrierter Bremse. (2 feststehende Räder und 2 Schwenkräder).



Capacity: 20 units of the cocktail80, praxis80 or bistrot70 tables.

Capacidad: 20 u. mesas cocktail80, praxis80 o bistrot70.

Capacité: 20 unités de tables cocktail80, praxis80 ou bistrot70.

Kapazität: 20 cocktail80, praxis80 - oder bistrot70-Tische.



Locking bar which moves along the side rails to fix the tables in position even at half load. The bar revolves around one of the rails to allow access to the back of the trolley, making it easier to load.

Barra bloqueadora que se desliza a lo largo de las barandillas laterales para fijar las mesas incluso a media carga. La barra pivota en una de las barandillas para dejar acceso libre hasta el fondo del carro para facilitar la carga.

Barre bloquante se déplaçant le long des rampes latérales afin de fixer les tables, y compris en demie charge. La barre pivote sur une des rampes afin de laisser accès libre jusqu'au fond du chariot et faciliter ainsi le chargement.

Am Rahmen verschiebbare Sicherungsstange zur Sicherung der Tische auch bei halber Wagenladung. Die Sicherungsstange lässt sich an einer Rahmenseite schwenken. Dadurch wird der Zutritt bis zum hinteren Ende des Wagens ermöglicht und das Auf- und Abladen erleichtert.



Code Código Code Code	EAN	Name Nombre Nom Name	Units per box Unidades por caja Unités par boîte Stückzahl pro Packung	Packaging size Medidas embalaje Dimensions emballage Verpackungsmaße	Packaging volume Volumen embalaje Volume d'emballage Verpackungsvolumen	Gross weight Peso bruto Poids brut Bruttogewicht	Loading quantity Unidades por contenedor Unités par conteneur Einheiten pro Container
RA-277	8437009886809	cocktailtrolley	1	118.3 x 92.7 x 12.7 cm 46.6" x 36.6" x 5"	0.140 m ³ 4.944 ft ³	26.9 kg 59.18 lb	Container 40': 380 Container 40' HC: 420

Bench with folding legs and one-piece top.
 Banco con patas plegables y sobre de una sola pieza.
 Banc avec pieds réglables et partie supérieure en une seule pièce.
 Bank mit Klappfüßen und Tischplatte aus einem Stück.

oktober**175**

BENCH BANCO BANC BANK



Limited
5-year
warranty

sharp**bench**

BENCH BANCO BANC BANK

240



Limited
5-year
warranty

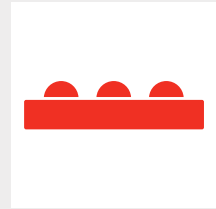

Capacity: 3 persons.
Area per person: 22.8".
Capacidad: 3 personas.
Espacio por persona: 58 cm.
Capacité: 3 personnes.
Espace par personne: 58 cm.
Kapazität: 3 Personen.
Platz pro Person: 58 cm.



One single piece. With folding legs.
Sobre de una sola pieza. Patas plegables.
Surface d'une seule pièce. Pieds repliables.
Tischplatte aus einem Stück. Klappfüße.



Sliding ring to lock the legs in position when in use. Easy and secure.
Argolla autodeslizante para bloquear las patas en posición de uso. Fácil y seguro.
Anneau autoglisant pour blocage des pieds en position d'usage. Facile et sûr.
Selbstgleitender Metallschiebering zur Feststellung der aufgeklappten Tischbeine. Einfach und sicher.

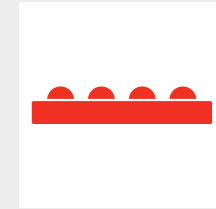

Capacity: 4 persons.
Area per person: 24".
Capacidad: 4 personas.
Espacio por persona: 61 cm.
Capacité: 4 personnes.
Espace par personne: 61 cm.
Bietet Platz für 4 Personen.
Platz pro Person: 61 cm.



Bench with folding top.
Banco con sobre plegable.
Banc avec surface pliable.
Bank mit zusammenklappbarer Sitzfläche.

thetextilecollection

stretch

plain

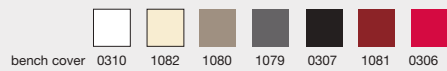

Code Código Code Code	EAN	Name Nombre Nom Name	Units per box Unidades por caja Unités par boîte Stückzahl pro Packung	Packaging size Medidas embalaje Dimensions emballage Verpackungsmaße	Packaging volume Volumen embalaje Volume d'emballage Verpackungsvolumen	Gross weight Peso bruto Poids brut Bruttogewicht	Loading quantity Unidades por contenedor Unités par conteneur Einheiten pro Container
PC-10	8437010781131	oktober 175	1	177 x 31.4 x 8.6 cm 69.7" x 12.4" x 3.4"	0.047 m ³ 1.659 ft ³	10.5 kg 23.10 lb	Container 40': 1320 Container 40' HC: 1500

Code Código Code Code	EAN	Name Nombre Nom Name	Units per box Unidades por caja Unités par boîte Stückzahl pro Packung	Packaging size Medidas embalaje Dimensions emballage Verpackungsmaße	Packaging volume Volumen embalaje Volume d'emballage Verpackungsvolumen	Gross weight Peso bruto Poids brut Bruttogewicht	Loading quantity Unidades por contenedor Unités par conteneur Einheiten pro Container
PC-13G	8436539290568	sharp bench240	1	124.5 x 32.1 x 17.5 cm 49" x 12.6" x 6.9"	0.069 m ³ 2.457 ft ³	12.59 kg 27.70 lb	Container 40': 857 Container 40' HC: 988

Bench with top that folds in half and carrying handle.
 Banco con sobre plegable por la mitad y asa para su transporte.
 Banc avec partie supérieure pliante par la moitié, et anse de transport.
 Bank mit in der Mitte klappbarer Sitzplatte und Tragegriff.

sharpbench

BENCH BANCO BANC BANK



8.1 kg
17.8 lb

400 kg
882 lb



HDPE
Light Grey
POWDER-COATED
STEEL
Grey

Limited
5-year
warranty

Table with top that folds in half and carrying handle.
 Mesa con sobre plegable por la mitad y asa para su transporte.
 Table avec partie supérieure pliante par la moitié, et anse de transport.
 Tisch mit in der Mitte klappbarer Tischplatte und Tragegriff.

sharptable

TABLE MESA TABLE TISCH



13.3 kg
29.3 lb

315 kg
694 lb



HDPE
Light Grey
POWDER-COATED
STEEL
Grey

Limited
10-year
warranty

H44.3 cm
H17.5"



L184 x W30.5 cm
L6' x W12"

48 mm

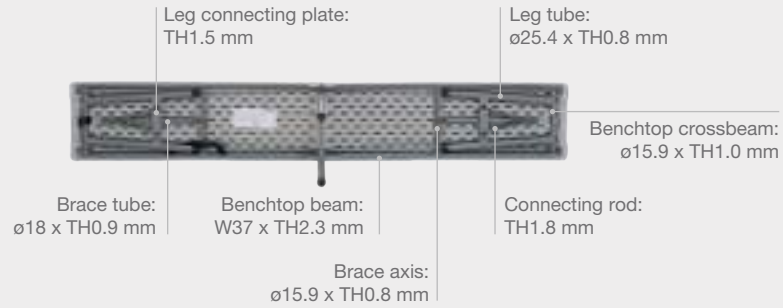

H74.3 cm
H29.2"



L182.9 x W76.2 cm
L6' x W30"

45 mm

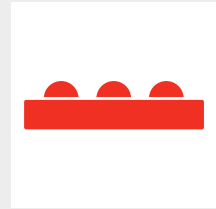

Capacity: 3 persons.
Area per person: 24".
 Capacidad: 3 personas.
Espacio por persona: 61 cm.
 Capacité: 3 personnes.
Espace par personne: 61 cm.
 Bietet Platz für 3 Personen.
Platz pro Person: 61 cm.



Bench with folding top.
Banco con sobre plegable.
 Banc avec surface pliable.
 Bank mit zusammenklappbarer Sitzfläche.



Bench provided with carrying handle for ease of transport.
 Banco provisto de un asa para su fácil desplazamiento.
 Banc muni d'une anse pour déplacement facile.
 Die Bank ist zur Vereinfachung des Transports mit einem Tragegriff für ausgestattet.



Sliding ring to lock the legs in position when in use. Easy and secure.
 Argolla autodeslizante para bloquear las patas en posición de uso. Fácil y seguro.
 Anneau autoglissant pour blocage des pieds en position d'usage. Facile et sûr.
 Selbstgleitender Metallschieber zur Feststellung der aufgeklappten Tischbeine. Einfach und sicher.

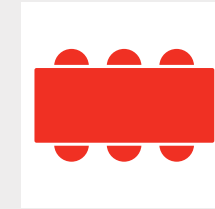

Capacity: 6 persons.
Area per person: 24".
 Capacidad: 6 personas.
Espacio por persona: 61 cm.
 Capacité: 6 personnes.
Espace par personne: 61 cm.
 Bietet Platz für 6 Personen.
Platz pro Person: 61 cm.

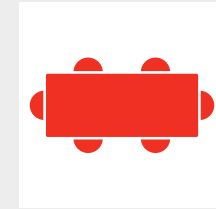

Capacity: 6 persons.
Area per person: 24".
 Capacidad: 6 personas.
Espacio por persona: 61 cm.
 Capacité: 6 personnes.
Espace par personne: 61 cm.
 Bietet Platz für 6 Personen.
Platz pro Person: 61 cm.



Folding table top.
Sobre plegable.
 Surface pliable.
 Zusammenklappbare Tischplatte.



Table provided with carrying handle for ease of transport.
 Mesa provista de un asa para su fácil desplazamiento.
 Table munie d'une anse pour déplacement facile.
 Tisch hat einen Griff für den einfachen Transport.



Sliding ring to lock the legs in position when in use. Easy and secure.
 Argolla autodeslizante para bloquear las patas en posición de uso. Fácil y seguro.
 Anneau autoglissant pour blocage des pieds en position d'usage. Facile et sûr.
 Selbstgleitender Metallschieber zur Feststellung der aufgeklappten Tischbeine. Einfach und sicher.

thetextilecollection

stretch

plain



bench cover 0317 1088 1086 1085 0314 1087 0313

bench cover 0386 1090 1089 0389 0387 0391 0390

thetextilecollection

stretch

paramount

plain



table cover 0261 0876 0874 0873 0258 0875 0257
 top cover 0508 0880 0878 0877 0505 0879 0504



table cover 0171 0884 0883 0174 0172 0176 0175
 tablecloth 0556



table cover 0404 0882 0881 0407 0405 0409 0408
 tablecloth 0556



Code Código Code Code	EAN	Name Nombre Nom Name	Units per box Unidades por caja Unités par boîte Stückzahl pro Packung	Packaging size Medidas embalaje Dimensions emballage Verpackungsmaße	Packaging volume Volumen embalaje Volume d'emballage Verpackungsvolumen	Gross weight Peso bruto Poids brut Bruttogewicht	Loading quantity Unidades por contenedor Unités par conteneur Einheiten pro Container
PC-15F	8437009886113	sharpbench180	1	95 x 33 x 11 cm 37.5" x 13" x 4.5"	0.031 m³ 1.115 ft³	8.76 kg 19.27 lb	Container 40': 1720 Container 40' HC: 1960

Code Código Code Code	EAN	Name Nombre Nom Name	Units per box Unidades por caja Unités par boîte Stückzahl pro Packung	Packaging size Medidas embalaje Dimensions emballage Verpackungsmaße	Packaging volume Volumen embalaje Volume d'emballage Verpackungsvolumen	Gross weight Peso bruto Poids brut Bruttogewicht	Loading quantity Unidades por contenedor Unités par conteneur Einheiten pro Container
BT-06FG	8437009886250	sharptable	1	77 x 95.5 x 10.5 cm 30.3" x 37.6" x 4.1"	0.077 m³ 2.719 ft³	15.8 kg 34.76 lb	Container 40': 810 Container 40' HC: 910

munich50

TABLE MESA TABLE TISCH

Beer table with special leg structure for soft and uneven ground.
Mesa cervecera con estructura de patas especial para suelos blandos e irregulares.
Table brasserie avec une structure de pieds spécialement conçue pour les sols mous et irréguliers.
Biertisch mit speziellem Fußgestell für weiche und unregelmäßige Böden.

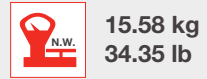

H77 cm
H30.3"



L220 x W50 cm
L86.6" x W19.6"

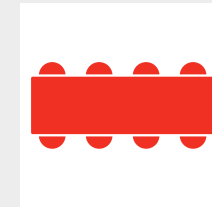
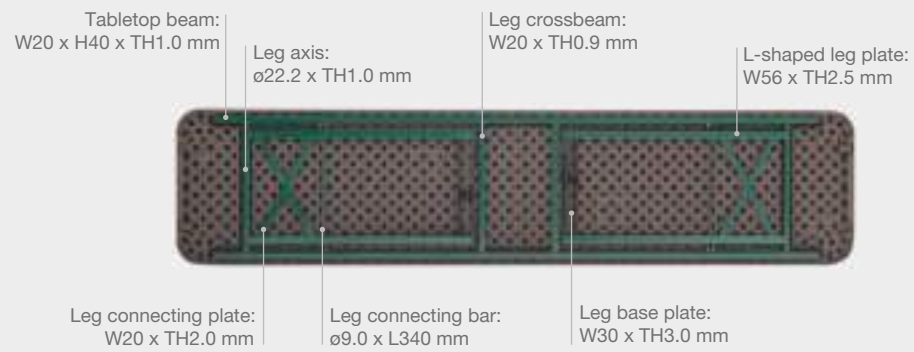

Capacity: 8 persons.
Area per person: 21.7".
Capacidad: 8 personas.
Espacio por persona: 55 cm.
Capacité: 8 personnes.
Espace par personne: 55 cm.
Bietet Platz für 8 Personen.
Platz pro Person: 55 cm.

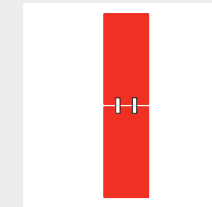

Longitudinal table joining system.
Sistema de unión longitudinal de mesas.
Système de raccord longitudinal de tables.
Vorrichtung zur längsseitigen Verbindung der Tische.



Longitudinal table joining system.
Sistema de unión longitudinal de mesas.
Système de raccord longitudinal de tables.
Vorrichtung zur längsseitigen Verbindung der Tische.



Base frame suitable for soft ground.
Base de apoyo apta para suelos blandos.
Base d'appui apte pour des sols meubles.
Beinrahmen für weiche Böden.



Manual lock (1) and sliding ring (2) for greater leg stability when in use.
Bloqueador manual (1) y argolla autodeslizante (2) para mayor seguridad de las patas en posición de uso.
Blocage manuel (1) et anneau autoglissant (2) pour plus de sécurité des pieds en position d'usage.
Manuelle Feststellung (1) und selbstgleitender Metallschieber (2) für eine höhere Sicherheit der Tischbeine in aufgeklappter Position.



Base with anti-scratch polypropylene foot caps.
Base con tacos anti-rayas de polipropileno.
Base avec talons anti-rayures de polypropylène.
Mit integrierten Bodenschonern.

the textile collection

stretch

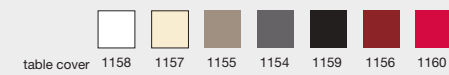

bridge



Code Código Code Code	EAN	Name Nombre Nom Name	Units per box Unidades por caja Unités par boîte Stückzahl pro Packung	Packaging size Medidas embalaje Dimensions emballage Verpackungsmaße	Packaging volume Volumen embalaje Volume d'emballage Verpackungsvolumen	Gross weight Peso bruto Poids brut Bruttogewicht	Loading quantity Unidades por contenedor Unités par conteneur Einheiten pro Container
PT004X002A	8436539299585	munich50	1	51.75 x 7 x 222.5 cm 20.37" x 2.75" x 87.62"	0.081 m³ 2.860 ft³	17.83 kg 39.31 lb	Container 40': 760 Container 40' HC: 850

Beer table with special leg structure for soft and uneven ground.
 Mesa cervecera con estructura de patas especial para suelos blandos e irregulares.
 Table brasserie avec une structure de pieds spécialement conçue pour les sols mous et irréguliers.
 Biertisch mit speziellem Fußgestell für weiche und unregelmäßige Böden.

munich70

TABLE MESA TABLE TISCH



8



18.3 kg
40.3 lb



350 kg
770 lb



Water-resistant



HOPE
BRASS
POWDER-COATED
STEEL
Green



munichbench

BENCH BANCO BANC BANK



4



13.3 kg
29.9 lb



400 kg
880 lb



Water-resistant



HOPE
BRASS
POWDER-COATED
STEEL
Green



H77 cm
H30.3"

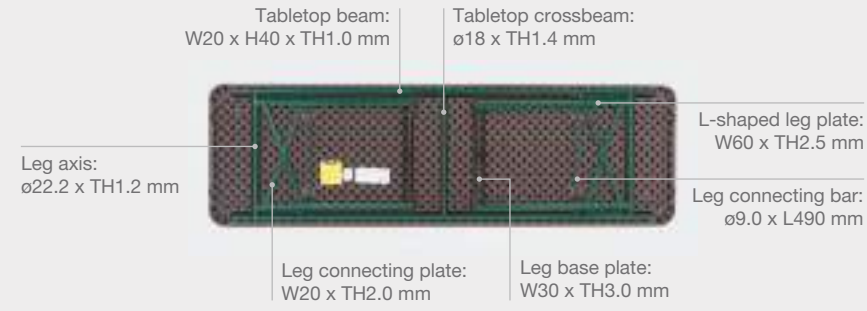

L220 x W67 cm
L86.6" x W26.4"



H48 cm
H18.9"



L220 x W30 cm
L86.6" x W11.8"

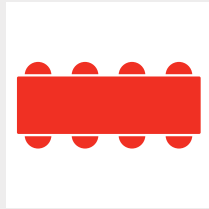

Capacity: 8 persons.
Area per person: 21.7".

Capacidad: 8 personas.
Espacio por persona: 55 cm.

Capacité: 8 personnes.
Espace par personne: 55 cm.

Bietet Platz für 8 Personen.
Platz pro Person: 55 cm.

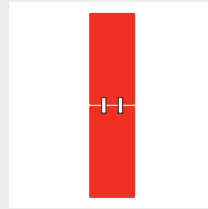

Longitudinal table joining system.
Sistema de unión longitudinal de mesas.

Système de raccord longitudinal de tables.

Vorrichtung zur längsseitigen Verbindung der Tische.



Longitudinal table joining system.
Sistema de unión longitudinal de mesas.

Système de raccord longitudinal de tables.

Vorrichtung zur längsseitigen Verbindung der Tische.



Base frame suitable for soft ground.
Base de apoyo apta para suelos blandos.

Base d'appui apte pour des sols meublés.

Beinrahmen für weiche Böden.



Manual lock (1) and sliding ring (2) for greater leg stability when in use.
Bloqueador manual (1) y argolla autodeslizante (2) para mayor seguridad de las patas en posición de uso.

Blocage manuel (1) et anneau autoglissant (2) pour plus de sécurité des pieds en position d'usage.

Mit integrierten Bodenschonern.

Manuelle Feststellung (1) und selbstgleitender Metallschiebering (2) für eine höhere Sicherheit der Tischbeine in aufgeklappter Position.



Base with anti-scratch polypropylene foot caps.
Base con tacos anti-rayas de polipropileno.

Base avec talons anti-rayures de polypropylène.

Mit integrierten Bodenschonern.

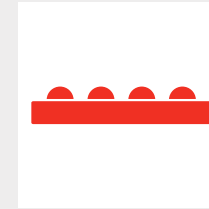

Capacity: 4 persons.
Area per person: 21.7".

Capacidad: 4 personas.
Espacio por persona: 55 cm.

Capacité: 4 personnes.
Espace par personne: 55 cm.

Bietet Platz für 4 Personen.
Platz pro Person: 55 cm.



Base frame suitable for soft ground.
Base de apoyo apta para suelos blandos.

Base d'appui apte pour des sols meublés.

Beinrahmen für weiche Böden.



Manual lock (1) and sliding ring (2) for greater leg stability when in use.
Bloqueador manual (1) y argolla autodeslizante (2) para mayor seguridad de las patas en posición de uso.

Blocage manuel (1) et anneau autoglissant (2) pour plus de sécurité des pieds en position d'usage.

Mit integrierten Bodenschonern.

Manuelle Feststellung (1) und selbstgleitender Metallschiebering (2) für eine höhere Sicherheit der Tischbeine in aufgeklappter Position.



Base with anti-scratch polypropylene foot caps.
Base con tacos anti-rayas de polipropileno.

Base avec talons anti-rayures de polypropylène.

Mit integrierten Bodenschonern.

thetextilecollection

stretch

bridge



set cover 0096 1094 1092 1091 0093 1093 0092



set cover 0099 1096 1095 0102 0100 0104 0103

Code Código Code Code	EAN	Name Nombre Nom Name	Units per box Unidades por caja Unités par boîte Stückzahl pro Packung	Packaging size Medidas embalaje Dimensions emballage Verpackungsmaße	Packaging volume Volumen embalaje Volume d'emballage Verpackungsvolumen	Gross weight Peso bruto Poids brut Bruttogewicht	Loading quantity Unidades por contenedor Unités par conteneur Einheiten pro Container
PT-46	8436539290285	munich70	1	222 x 69 x 7 cm 87.6" x 27.1" x 2.7"	0.107 m ³ 3.778 ft ³	20 kg 44 lb	Container 40': 570 Container 40' HC: 645

Code Código Code Code	EAN	Name Nombre Nom Name	Units per box Unidades por caja Unités par boîte Stückzahl pro Packung	Packaging size Medidas embalaje Dimensions emballage Verpackungsmaße	Packaging volume Volumen embalaje Volume d'emballage Verpackungsvolumen	Gross weight Peso bruto Poids brut Bruttogewicht	Loading quantity Unidades por contenedor Unités par conteneur Einheiten pro Container
PC-27	8436539290278	munichbench	1	222 x 32 x 6.9 cm 87.6" x 12.6" x 2.7"	0.049 m ³ 1.730 ft ³	15.2 kg 33.44 lb	Container 40': 1221 Container 40' HC: 1396

Stainless steel bench with optional wheels.
 Banco de trabajo de acero inoxidable con ruedas opcionales.
 Banc de travail en acier inoxydable, avec roulettes en option.
 Arbeitsbank aus Edelstahl mit optionalen Rädern.

SS60

TABLE MESA TABLE TISCH



11.6 kg
25.57 lb



Water-resistant



SS304



Height adjuster on the 4 legs.
 Regulador de altura en las 4 patas.
 Niveau réglable des 4 pieds.
 Integrierte Höhenverstellung an den 4 Tischbeinen.



Set of four wheels available (two of which have a built-in brake). By adding the wheels, it can also serve the function of a "mobile work table" or "trolley".
 Set de cuatro ruedas disponible (dos de ellas con freno incorporado). Al incorporar las ruedas, puede cumplir también la función de "mesa de trabajo móvil" o de "carro".
 Set de quatre roues disponible (deux d'entre elles avec frein incorporé). L'incorporation des quatre roues permet d'assurer aussi la fonction de "table de travail mobile" ou de "chariot".
 Räder-Set mit vier Rädern lieferbar (zwei davon mit eingebauter Bremse). Durch den Einbau der Räder kann der Tisch auch als "fahrbare Arbeitstisch" oder "Wagen" eingesetzt werden.



Tabletop beam plate:
SS#304, TH 0.7 mm

Tabletop:
SS#304, TH 0.7 mm

Leg tube: SS#304,
size: ø42 x TH1.5 mm,
with level adjusters

Shelf plate:
SS#304, TH 0.7 mm

Code Código Code Code	EAN	Name Nombre Nom Name	Units per box Unidades por caja Unités par boîte Stückzahl pro Packung	Packaging size Medidas embalaje Dimensions emballage Verpackungsmaße	Packaging volume Volumen embalaje Volume d'emballage Verpackungsvolumen	Gross weight Peso bruto Poids brut Bruttogewicht	Loading quantity Unidades por contenedor Unités par conteneur Einheiten pro Container
OT002X001	8436539296485	SS60 table	Carton A Carton B	62.9 x 64.5 x 12.4 cm 24.7" x 25.4" x 4.9" 19 x 5.7 x 89 cm 7.5" x 2.3" x 35"	0.120 m ³ 4.237 ft ³	13.4 kg 29.54 lb	Container 40': 760 Container 40' HC: 876
107DG006A004A	8436539296492	SSwheels set	1	20 x 20 x 20 cm 7.9" x 7.9" x 7.9"	0.008 m ³ 0.282 ft ³		Container 40': 4300 Container 40' HC: 8700

Stainless steel bench with optional wheels.
 Banco de trabajo de acero inoxidable con ruedas opcionales.
 Banc de travail en acier inoxydable, avec roulettes en option.
 Arbeitsbank aus Edelstahl mit optionalen Rädern.

SS120

TABLE MESA TABLE TISCH



20.2 kg
44.53 lb



Water-resistant



SS304



Height adjuster on the 4 legs.
 Regulador de altura en las 4 patas.
 Niveau réglable des 4 pieds.
 Integrierte Höhenverstellung an den 4 Tischbeinen.



Set of four wheels available (two of which have a built-in brake). By adding the wheels, it can also serve the function of a "mobile work table" or "trolley".
 Set de cuatro ruedas disponible (dos de ellas con freno incorporado). Al incorporar las ruedas, puede cumplir también la función de "mesa de trabajo móvil" o de "carro".
 Set de quatre roues disponible (deux d'entre elles avec frein incorporé). L'incorporation des quatre roues permet d'assurer aussi la fonction de "table de travail mobile" ou de "chariot".
 Räder-Set mit vier Rädern lieferbar (zwei davon mit eingebauter Bremse). Durch den Einbau der Räder kann der Tisch auch als "fahrbare Arbeitstisch" oder "Wagen" eingesetzt werden.



Tabletop beam plate:
SS#304, TH1.0 x W171 mm

Tabletop plate:
SS#304, TH1.0 x W717 mm

Tabletop beam plate:
SS#304, TH1.0 x W161.5 mm

Shelf plate:
SS#304, TH1.0 x W526.2 mm

Legs: SS#304,
size: ø42, TH1.5 mm,
with level adjusters

Code Código Code Code	EAN	Name Nombre Nom Name	Units per box Unidades por caja Unités par boîte Stückzahl pro Packung	Packaging size Medidas embalaje Dimensions emballage Verpackungsmaße	Packaging volume Volumen embalaje Volume d'emballage Verpackungsvolumen	Gross weight Peso bruto Poids brut Bruttogewicht	Loading quantity Unidades por contenedor Unités par conteneur Einheiten pro Container
OT001X001	8436539296416	SS120 table	1	128.3 x 67.3 x 14 cm 50.5" x 26.5" x 5.5"	0.120 m ³ 4.237 ft ³	21.55 kg 47.5 lb	Container 40': 575 Container 40' HC: 651
107DG006A004A	8436539296492	SSwheels set	1	20 x 20 x 20 cm 7.9" x 7.9" x 7.9"	0.008 m ³ 0.282 ft ³		Container 40': 4300 Container 40' HC: 8700



Ultra-lightweight chair with high load capacity.
Silla plegable ultraligera con alta capacidad de carga.
Chaise pliante ultra-légère haute résistance.
Ultraleichter, hoch belastbarer Klappstuhl.

alexchair

CHAIR SILLA CHAISE STUHL



2.75 kg
6.1 lb



190 kg
420 lb



Water-resistant



H80.3 cm
H31.6"

L45.1 x W43.8 cm
L17.75" x W17.24"



Leg tube:
ø19.1 x TH0.85 mm

Steel plate:
TH0.8 mm

Crossbar:
ø15.9 x TH0.75 mm



PP
Light Grey
POWDER-COATED
STEEL
Light Grey

PP
Black
POWDER-COATED
STEEL
Black

PP
White
POWDER-COATED
STEEL
White



Alextrolley available for 60 chairs. See page 102.

Alextrolley disponible para 60 sillas. Ver pág.102.

Alextrolley disponible pour 60 chaises. Voir page 102.

Wagen alextrolley lieferbar für 60 Stühle. Siehe S.102.

thetextilecollection

stretch

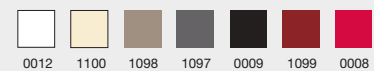

0012 1100 1098 1097 0009 1099 0008

classic



0056 1102 1101 0059 0057 0061 0060

sashes

classic



twist



plain

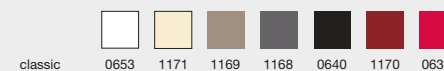

classic 0653 1171 1169 1168 0640 1170 0639
twist 0682 1175 1173 1172 0679 1174 0678
plain 0661 1179 1177 1176 0658 1178 0657

Code Código Code Code	EAN	Name Nombre Nom Name	Units per box Unidades por caja Unités par boîte Stückzahl pro Packung	Packaging size Medidas embalaje Dimensions emballage Verpackungsmaße	Packaging volume Volumen embalaje Volume d'emballage Verpackungsvolumen	Gross weight Peso bruto Poids brut Bruttogewicht	Loading quantity Unidades por contenedor Unités par conteneur Einheiten pro Container
GC-52G	8437009886274	alexchair grey	8	45.7 x 26.3 x 99 cm	0.119 m ³	23.4 kg	Container 40': 4320
GC-52B	8437009886298	alexchair black		18" x 10.4" x 39"	4.202 ft ³	51.48 lb	Container 40' HC: 4800
GC-52W	8437009886311	alexchair white					

Ultra-lightweight chair with high load capacity and lateral joining system.
Silla plegable ultraligera con alta capacidad de carga y sistema de unión lateral.
Chaise pliante ultra-légère haute résistance avec système de raccord latéral.
Ultraleichter, hoch belastbarer Klappstuhl mit seitlichem Verbindungssystem.

alex-kchair

CHAIR SILLA CHAISE STUHL



2.75 kg
6.1 lb



190 kg
420 lb



Water-resistant



H80.3 cm
H31.6"

L46.4 x W43.8 cm
L18.26" x W17.24"



Leg tube:
ø19.1 x TH0.85 mm

(-) Chair connector:
TH2.0 mm

PP-injected seat
and backrest

Steel plate:
TH0.8 mm

Crossbar:
ø15.9 x TH0.75 mm

(+) Chair connector:
TH2.0 mm



PP
Light Grey
POWDER-COATED
STEEL
Light Grey

PP
Black
POWDER-COATED
STEEL
Black

PP
White
POWDER-COATED
STEEL
White



With joining system.

Con sistema de unión.

Avec système de raccord.

Mit Verbindungssystem.



Alextrolley available for 60 chairs. See page 102.

Alextrolley disponible para 60 sillas. Ver pág.102.

Alextrolley disponible pour 60 chaises. Voir page 102.

Wagen alextrolley lieferbar für 60 Stühle. Siehe S.102.

thetextilecollection

stretch

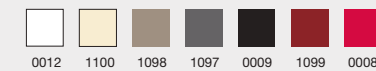

0012 1100 1098 1097 0009 1099 0008

classic



0056 1102 1101 0059 0057 0061 0060

sashes

classic



twist



plain

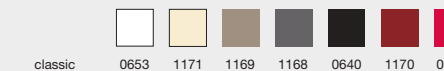

classic 0653 1171 1169 1168 0640 1170 0639
twist 0682 1175 1173 1172 0679 1174 0678
plain 0661 1179 1177 1176 0658 1178 0657

Code Código Code Code	EAN	Name Nombre Nom Name	Units per box Unidades por caja Unités par boîte Stückzahl pro Packung	Packaging size Medidas embalaje Dimensions emballage Verpackungsmaße	Packaging volume Volumen embalaje Volume d'emballage Verpackungsvolumen	Gross weight Peso bruto Poids brut Bruttogewicht	Loading quantity Unidades por contenedor Unités par conteneur Einheiten pro Container
GC-52K-G	8436539290209	alex-kchair grey	8	48.8 x 26.2 x 98.3 cm	0.127 m ³	23.75 kg	Container 40': 3840
GC-52K-B	8436539290629	alex-kchair black		19.2" x 10.3" x 38.7"	4.484 ft ³	52.26 lb	Container 40' HC: 4320
GC-52K-W	8436539290612	alex-kchair white					



Ultra-lightweight chair with a high backrest and high load capacity.
Silla plegable ultraligera de respaldo alto, con alta capacidad de carga.
Chaise pliante ultra-légère au dossier haut, haute résistance.
Ultraleichter, hoch belastbarer Klappstuhl mit hoher Rückenlehne.

alexandra**chair**

CHAIR SILLA CHAISE STUHL



2.8 kg
6.2 lb



190 kg
420 lb



Water-resistant

Ultra-lightweight chair with a high backrest, high load capacity and lateral joining system.
Silla plegable ultraligera de respaldo alto, con alta capacidad de carga y sistema de unión lateral.
Chaise pliante ultra-légère au dossier haut, haute résistance et avec un système de raccord latéral.
Ultraleichter, hoch belastbarer Klappstuhl mit hoher Rückenlehne und seitlichem Verbindungssystem.

alexandra-**k**chair

CHAIR SILLA CHAISE STUHL



2.8 kg
6.2 lb



190 kg
420 lb



Water-resistant



H87.5 cm
H34.44"

L45.1 x W43.2 cm
L17.7" x W17"



PP-injected
backrest and seat

Steel plate:
TH0.8 mm

Leg tube:
ø19.1 x TH0.85 mm

Crossbar:
ø15.9 x TH0.75 mm



H87.5 cm
H34.44"

L46.6 x W53.8 cm
L18.3" x W21.2"

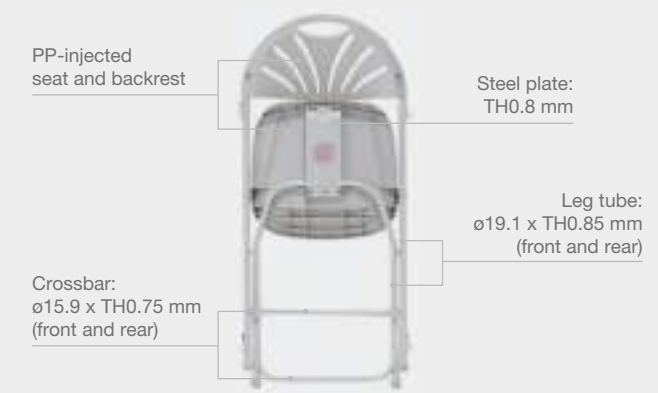

PP-injected
seat and backrest

Steel plate:
TH0.8 mm

Leg tube:
ø19.1 x TH0.85 mm
(front and rear)

Crossbar:
ø15.9 x TH0.75 mm
(front and rear)



PP
Light Grey
POWDER-COATED
STEEL
Light Grey

PP
Black
POWDER-COATED
STEEL
Black

PP
White
POWDER-COATED
STEEL
White

Alexandratrolley available for 60 chairs. See page 103.

Alexandratrolley disponible para 60 sillas. Ver pág.103.

Alexandratrolley disponible pour 60 chaises. Voir page 103.

Wagen alexandratrolley lieferbar für 60 Stühle. Siehe S.103.



PP
Light Grey
POWDER-COATED
STEEL
Light Grey

PP
Black
POWDER-COATED
STEEL
Black

PP
White
POWDER-COATED
STEEL
White

With joining system.

Con sistema de unión.

Avec système de raccord.

Mit Verbindungssystem.

Ergonomic handle.

Asidero ergonómico.

Anse ergonomique.

Ergonomischer Griff.

Alexandratrolley available for 60 chairs. See page 103.

Alexandratrolley disponible para 60 sillas. Ver pág.103.

Alexandratrolley disponible pour 60 chaises. Voir page 103.

Wagen alexandratrolley lieferbar für 60 Stühle. Siehe S.103.

thetextilecollection

stretch **classic** **sashes classic** **twist** **plain**

0005 1106 1104 1103 0002 1105 0001

0050 1108 1107 0053 0051 0055 0054

classic 0653 1171 1169 1168 0640 1170 0639
twist 0682 1175 1173 1172 0679 1174 0678
plain 0661 1179 1177 1176 0658 1178 0657

thetextilecollection

stretch **classic** **sashes classic** **twist** **plain**

0005 1106 1104 1103 0002 1105 0001

0050 1108 1107 0053 0051 0055 0054

classic 0653 1171 1169 1168 0640 1170 0639
twist 0682 1175 1173 1172 0679 1174 0678
plain 0661 1179 1177 1176 0658 1178 0657

Code Código Code Code	EAN	Name Nombre Nom Name	Units per box Unidades por caja Unités par boîte Stückzahl pro Packung	Packaging size Medidas embalaje Dimensions emballage Verpackungsmaße	Packaging volume Volumen embalaje Volume d'emballage Verpackungsvolumen	Gross weight Peso bruto Poids brut Bruttogewicht	Loading quantity Unidades por contenedor Unités par conteneur Einheiten pro Container
GC-50G	8437010781414	alexandra chair grey	8	45.9 x 28.4 x 107.7 cm 18.1" x 11.2" x 42.4"	0.140 m ³ 4.944 ft ³	23.7 kg 52.14 lb	Container 40': 3520 Container 40' HC: 4040
GC-50B	8437010781421	alexandra chair black					
GC-50W	8437010781438	alexandra chair white					

Code Código Code Code	EAN	Name Nombre Nom Name	Units per box Unidades por caja Unités par boîte Stückzahl pro Packung	Packaging size Medidas embalaje Dimensions emballage Verpackungsmaße	Packaging volume Volumen embalaje Volume d'emballage Verpackungsvolumen	Gross weight Peso bruto Poids brut Bruttogewicht	Loading quantity Unidades por contenedor Unités par conteneur Einheiten pro Container
GC-50K-G	8436539290599	alexandra- k chair grey	8	48.8 x 27.4 x 106 cm 19.2" x 10.8" x 41.7"	0.143 m ³ 5.049 ft ³	23.7 kg 52.14 lb	Container 40': 3200 Container 40' HC: 3600
GC-50K-B	8436539290605	alexandra- k chair black					
GC-50K-W	8436539290582	alexandra- k chair white					

Special trolley for transporting and storing the Alex and Alex-K chairs.
 Carro especial para el transporte y almacenaje de las sillas Alex y Alex-K.
 Chariot spécial pour le transport et le stockage des tables Alex et Alex-K.
 Spezieller Transport- und Lagerwagen für die Stühle Alex und Alex-K.

alextrrolley

TROLLEY CARRO CHARIOT WAGEN



19.4 kg
41.9 lb



H196.8 cm
H77.5"

L95.4 x W47.5 cm
L37.5" x W18.7"



Easy locking and unlocking of the vertical posts. Ease of access for loading and unloading.
 Fácil bloqueo y desbloqueo de los postes verticales. Cómodo acceso para cargar o descargar.
 Poteaux verticaux faciles à bloquer et débloquer. Accès pratique pour chargement ou déchargement.
 Leichtes Blockieren und Entriegeln der senkrechten Stangen. Bequemer Zugriff zum Ein- oder Ausladen.



Handle specially designed to protect the hands and to occupy a minimum of space.
 Asa especialmente diseñada para proteger las manos y ocupar el mínimo espacio.
 Anse spécialement conçue pour protéger les mains et occuper un espace minime.
 Besonders geformter Griff zum Schutz der Hände und platzsparend.



Vertical posts to hold the stacked chairs in place.
 Postes verticales para inmovilizar las sillas apiladas.
 Poteaux verticaux pour immobilisation des chaises empilées.
 Senkrechte Stangen geben den gestapelten Stühlen Halt.



Four polyurethane wheels with built-in brake. (Two fixed wheels and two pivoting wheels).
 4 ruedas de poliuretano con freno incorporado (2 ruedas fijas y 2 ruedas pivotantes).
 4 roulettes en polyuréthane avec frein intégré. (2 roulettes fixes et 2 roulettes pivotantes).
 4 PU-Räder mit integrierter Bremse. (2 feststehende Räder und 2 Schwenkräder).



Capacity: 60 pcs. Alex or Alex-K chairs.
 Capacidad: 60u. Sillas Alex o Alex-K.
 Capacité: 60u. Chaises Alex ou Alex-K.
 Fassungsvermögen: 60 Stk. Stühle Alex oder Alex-K.

Code Código Code Code	EAN	Name Nombre Nom Name	Units per box Unidades por caja Unités par boîte Stückzahl pro Packung	Packaging size Medidas embalaje Dimensions emballage Verpackungsmaße	Packaging volume Volumen embalaje Volume d'emballage Verpackungsvolumen	Gross weight Peso bruto Poids brut Bruttogewicht	Loading quantity Unidades por contenedor Unités par conteneur Einheiten pro Container
RA-104A	8437009886137	alextrrolley	1	102.1 x 54.8 x 12 cm 40.2" x 21.6" x 4.7"	0.068 m ³ 2.401 ft ³	21.2 kg 46.6 lb	Container 40': 910 Container 40' HC: 1010

Special trolley for transporting and storing the Alexandra and Alexandra-K chairs.
 Carro especial para el transporte y almacenaje de las sillas Alexandra y Alexandra-K.
 Chariot spécial pour le transport et le stockage des chaises Alexandra et Alexandra-K.
 Spezieller Transport- und Lagerwagen für die Stühle Alexandra und Alexandra-K.

alexandratrolley

TROLLEY CARRO CHARIOT WAGEN



19.5 kg
43 lb



H196.8 cm
H77.5"

L113.5 x W47.5 cm
L44.7" x W18.7"

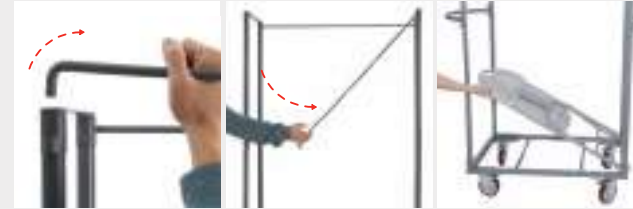

Easy locking and unlocking of the vertical posts. Ease of access for loading and unloading.
 Fácil bloqueo y desbloqueo de los postes verticales. Cómodo acceso para cargar o descargar.
 Poteaux verticaux faciles à bloquer et débloquer. Accès pratique pour chargement ou déchargement.
 Leichtes Blockieren und Entriegeln der senkrechten Stangen. Bequemer Zugriff zum Ein- oder Ausladen.



Handle specially designed to protect the hands and to occupy a minimum of space.
 Asa especialmente diseñada para proteger las manos y ocupar el mínimo espacio.
 Anse spécialement conçue pour protéger les mains et occuper un espace minime.
 Besonders geformter Griff zum Schutz der Hände und platzsparend.



Vertical posts to hold the stacked chairs in place.
 Postes verticales para inmovilizar las sillas apiladas.
 Poteaux verticaux pour immobilisation des chaises empilées.
 Senkrechte Stangen geben den gestapelten Stühlen Halt.



Four polyurethane wheels with built-in brake. (Two fixed wheels and two pivoting wheels).
 4 ruedas de poliuretano con freno incorporado (2 ruedas fijas y 2 ruedas pivotantes).
 4 roulettes en polyuréthane avec frein intégré. (2 roulettes fixes et 2 roulettes pivotantes).
 4 PU-Räder mit integrierter Bremse. (2 feststehende Räder und 2 Schwenkräder).



Capacity: 60 pcs. Alexandra or Alexandra-K chairs.
 Capacidad 60u. Sillas Alexandra o Alexandra-K.
 Capacité: 60u. Chaises Alexandra ou Alexandra-K.
 Fassungsvermögen: 60 Stk. Stühle Alexandra oder Alexandra-K.

Code Código Code Code	EAN	Name Nombre Nom Name	Units per box Unidades por caja Unités par boîte Stückzahl pro Packung	Packaging size Medidas embalaje Dimensions emballage Verpackungsmaße	Packaging volume Volumen embalaje Volume d'emballage Verpackungsvolumen	Gross weight Peso bruto Poids brut Bruttogewicht	Loading quantity Unidades por contenedor Unités par conteneur Einheiten pro Container
RA-104-01	8437010781858	alexandratrolley	1	100 x 55 x 12 cm 39.5" x 21.6" x 4.75"	0.066 m ³ 2.330 ft ³	21.7 kg 47.8 lb	Container 40': 910 Container 40' HC: 1010



Folding chair with a wide seat. Robust and designed for intensive use.
Silla plegable de amplio asiento. Robusta e indicada para uso intensivo.
Chaise pliante au dossier large. Robuste et indiquée pour un usage intensif.
Klappstuhl mit breitem Sitz. Robust, für intensive Nutzung geeignet.

ottochair

CHAIR SILLA CHAISE STUHL



5.15 kg
11.4 lb



225 kg
500 lb



Water-resistant



HDPE
Light Grey
POWDER-COATED
STEEL
Grey

Limited
5-year
warranty

Special trolley for transporting and storing Otto chairs.
Carro especial para el transporte y almacenaje de las sillas Otto.
Chariot spécial pour le transport et le stockage des chaises Otto.
Spezieller Transport- und Lagerwagen für die Stühle Otto.

ottotrolley

TROLLEY CARRO CHARIOT WAGEN



19.7 kg
43.34 lb



POWDER-COATED
STEEL
Grey

H84.8 cm
H33.38"



L47 x W54 cm
L18.5" x W21.26"

HDPE seat
and backrest

L-shaped seat
beam plate:
W31.75 x TH2.0 mm
(front and rear)

Leg tube:
ø28.6 x TH0.9 mm



Crossbeam seat
plate: TH2.0 mm
(back/seat)

Crossbar:
ø18 x TH0.9 mm
(front and rear)

H190 cm
H74.8"



L110 x W47.7 cm
L43.3" x W18.8"



Chair connector available. The distance between the two chairs with the link is 109 mm.

Conector de sillas disponible. La distancia entre las dos sillas con el link es de 109 mm.

Connecteur de chaises disponible. La distance entre les deux chaises avec le lien est de 109 mm.

Verbindungsstück für die Stühle erhältlich. Der Abstand zwischen den beiden Stühlen mit Verbindung beträgt 109 mm.



Ergonomic crosspiece.

Travesaño ergonómico.

Barre transversale ergonomique.

Ergonomisch geformte Querstrebe.



Ergonomic handle.

Asidero ergonómico.

Anse ergonomique.

Ergonomischer Griff.



Ottotrolley available for 30 chairs. See page 107.

Ottotrolley disponible para 30 sillas. Ver pág. 107.

Ottotrolley disponible pour 30 chaises. Voir page 107.

Wagen ottotrolley lieferbar für 30 Stühle. Siehe S.107.

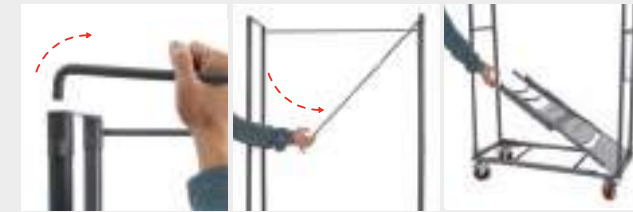

Easy locking and unlocking of the vertical posts. Ease of access for loading and unloading.

Fácil bloqueo y desbloqueo de los postes verticales. Cómodo acceso para cargar o descargar.

Poteaux verticaux faciles à bloquer et débloquer. Accès pratique pour chargement ou déchargement.

Leichtes Blockieren und Entriegeln der senkrechten Stangen. Bequemer Zugriff zum Ein- oder Ausladen.

thetextilecollection

stretch

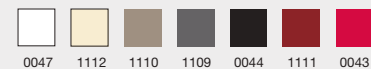

0047 1112 1110 1109 0044 1111 0043

classic



0086 1114 1113 0089 0087 0091 0090

sashes

classic



twist



plain

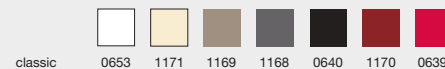

classic 0653 1171 1169 1168 0640 1170 0639
twist 0682 1175 1173 1172 0679 1174 0678
plain 0661 1179 1177 1176 0658 1178 0657



Vertical posts to hold the stacked chairs in place.

Postes verticales para inmovilizar las sillas apiladas.

Poteaux verticaux pour immobilisation des chaises empilées.

Senkrechte Stangen geben den gestapelten Stühlen Halt.



Four polyurethane wheels with built-in brake. (Two fixed wheels and two pivoting wheels).

4 ruedas de poliuretano con freno incorporado (2 ruedas fijas y 2 ruedas pivotantes).

4 roulettes en polyuréthane avec frein intégré. (2 roulettes fixes et 2 roulettes pivotantes).

4 PU-Räder mit integrierter Bremse. (2 feststehende Räder und 2 Schwenkräder).



Capacity: 30 pcs. Ottochair.

Capacidad: 30u. Ottochair.

Capacité: 30u. Ottochair.

Fassungsvermögen: 30 Stk. Ottochair.

Code Código Code Code	EAN	Name Nombre Nom Name	Units per box Unidades por caja Unités par boîte Stückzahl pro Packung	Packaging size Medidas embalaje Dimensions emballage Verpackungsmaße	Packaging volume Volumen embalaje Volume d'emballage Verpackungsvolumen	Gross weight Peso bruto Poids brut Bruttogewicht	Loading quantity Unidades por contenedor Unités par conteneur Einheiten pro Container
PC-02	8437009886267	ottochair	4	48.6 x 28.6 x 111.1 cm 19.1" x 11.2" x 43.7"	0.154 m ³ 5.438 ft ³	22.89 kg 50.36 lb	Container 40': 1544 Container 40' HC: 1740
RA-115	8437009886304	ottolink	50				

Code Código Code Code	EAN	Name Nombre Nom Name	Units per box Unidades por caja Unités par boîte Stückzahl pro Packung	Packaging size Medidas embalaje Dimensions emballage Verpackungsmaße	Packaging volume Volumen embalaje Volume d'emballage Verpackungsvolumen	Gross weight Peso bruto Poids brut Bruttogewicht	Loading quantity Unidades por contenedor Unités par conteneur Einheiten pro Container
RA-103A	8437009886120	ottotrolley	1	125.5 x 59.4 x 14 cm 49.4" x 23.4" x 5.5"	0.104 m ³ 3.672 ft ³	22 kg 48.8 lb	Container 40': 846 Container 40' HC: 940

Folding chair with wide and ergonomic seat. Robust and designed for intensive use.
Silla plegable con asiento amplio y ergonómico. Robusta e indicada para uso intensivo.
Chaise pliante au dossier large et ergonomique. Robuste et indiquée pour un usage intensif.
Klappstuhl mit breitem, ergonomisch geformtem Sitz. Robust, für intensive Nutzung geeignet.

normanchair

CHAIR SILLA CHAISE STUHL



5.1 kg
11.2 lb



225 kg
500 lb



Water-resistant

Limited
5-year
warranty

Special trolley for transporting and storing Norman chairs.
Carro especial para el transporte y almacenaje de las sillas Norman.
Chariot spécial pour le transport et le stockage des chaises Norman.
Spezieller Transport- und Lagerwagen für die Stühle Norman.

normantrolley

TROLLEY CARRO CHARIOT WAGEN



20.1 kg
43.8 lb



POWDER-COATED
STEEL
Grey



HDPE
Light Grey
POWDER-COATED
STEEL
Light Grey

HDPE
White
POWDER-COATED
STEEL
White

Ergonomic handle.
Asidero ergonómico.
Anse ergonomique.
Ergonomischer Griff.

Ergonomic crosspiece and seat.
Travesaño y asidero ergonómicos.
Barre transversale et siège ergonomiques.
Ergonomisch Sitz und geformte Querstrebe.

Ergonomic back.
Respaldo ergonómico.
Dossier ergonomique.
Ergonomische Rückenlehne.

Chair connector available. The distance between the two chairs with the link is 109 mm.
Conector de sillas disponible. La distancia entre las dos sillas con el link es de 109 mm.
Connecteur de chaises disponible. La distance entre les deux chaises avec le lien est de 109 mm.
Verbindungsstück für die Stühle erhältlich. Der Abstand zwischen den beiden Stühlen mit Verbindung beträgt 109 mm.

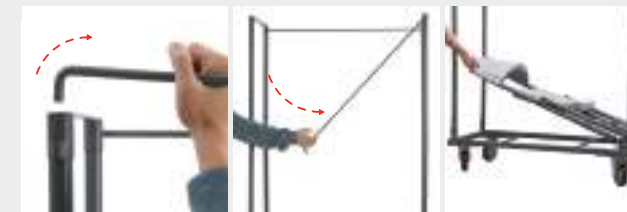

Easy locking and unlocking of the vertical posts. Ease of access for loading and unloading.
Fácil bloqueo y desbloqueo de los postes verticales. Cómodo acceso para cargar o descargar.
Poteaux verticaux faciles à bloquer et débloquer. Accès pratique pour chargement ou déchargement.
Leichtes Blockieren und Entriegeln der senkrechten Stangen. Bequemer Zugriff zum Ein- oder Ausladen.

thetextilecollection

stretch



0040 1118 1116 1115 0037 1117 0036

classic



0086 1120 1119 0089 0087 0091 0090

sashes
classic



classic



twist



plain

0653 1171 1169 1168 0640 1170 0639
0682 1175 1173 1172 0679 1174 0678
0661 1179 1177 1176 0658 1178 0657



Vertical posts to hold the stacked chairs in place.
Postes verticaux para inmovilizar las sillas apiladas.
Poteaux verticaux pour immobilisation des chaises empilées.
Senkrechte Stangen geben den gestapelten Stühlen Halt.



Four polyurethane wheels with built-in brake. (Two fixed wheels and two pivoting wheels).
4 ruedas de poliuretano con freno incorporado (2 ruedas fijas y 2 ruedas pivotantes).
4 roulettes en polyuréthane avec frein intégré. (2 roulettes fixes et 2 roulettes pivotantes).
4 PU-Räder mit integrierter Bremse. (2 feststehende Räder und 2 Schwenkräder).



Capacity: 27 pcs. **Normanchair.**
Capacidad: 27u. **Normanchair.**
Capacité: 27u. **Normanchair.**
Fassungsvermögen: 27 Stk. **Normanchair.**

Code Código Code Code	EAN	Name Nombre Nom Name	Units per box Unidades por caja Unités par boîte Stückzahl pro Packung	Packaging size Medidas embalaje Dimensions emballage Verpackungsmaße	Packaging volume Volumen embalaje Volume d'emballage Verpackungsvolumen	Gross weight Peso bruto Poids brut Bruttogewicht	Loading quantity Unidades por contenedor Unités par conteneur Einheiten pro Container
PC-23-G	8437009886328	normanchairgrey	4	48.6 x 31.7 x 114.3 cm 19.1" x 12.5" x 45"	0.176 m ³ 6.215 ft ³	23.4 kg 51.48 lb	Container 40': 1336 Container 40' HC: 1536
PC-23-B	8436539296614	normanchairblack					
PC-23-W	8436539296638	normanchairwhite					
RA-115	8437009886304	ottolink					

Code Código Code Code	EAN	Name Nombre Nom Name	Units per box Unidades por caja Unités par boîte Stückzahl pro Packung	Packaging size Medidas embalaje Dimensions emballage Verpackungsmaße	Packaging volume Volumen embalaje Volume d'emballage Verpackungsvolumen	Gross weight Peso bruto Poids brut Bruttogewicht	Loading quantity Unidades por contenedor Unités par conteneur Einheiten pro Container
RA-103-01	8437009886786	normantrolley	1	117.5 x 51.4 x 12 cm 46.2" x 20.2" x 4.7"	0.072 m ³ 2.542 ft ³	22.2 kg 48.8 lb	Container 40': 846 Container 40' HC: 940

Folding metallic chair with lateral joining system.
Silla metálica plegable con sistema de unión lateral.
Chaise métallique pliante avec système de raccord d'angle latéral.
Klappstuhl aus Metall mit seitlichem Verbindungssystem.

boston-kchair

CHAIR SILLA CHAISE STUHL



4.3 kg
9.46 lb



225 kg
500 lb

Limited
5-year
warranty

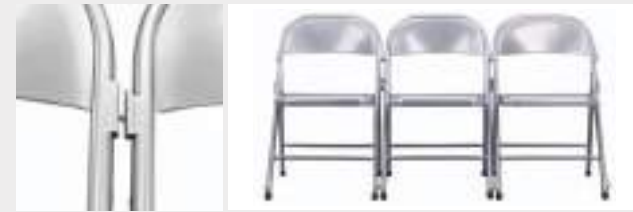

With joining system.
Con sistema de unión.
Avec système de raccord.
Mit Verbindungssystem.

thetextilecollection

stretch

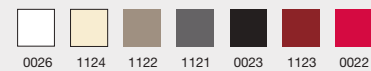

classic



sashes
classic



twist



plain

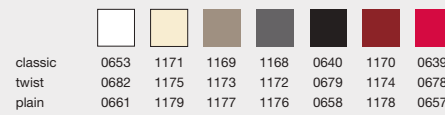

Code Código Code Code	EAN	Name Nombre Nom Name	Units per box Unidades por caja Unités par boîte Stückzahl pro Packung	Packaging size Medidas embalaje Dimensions emballage Verpackungsmaße	Packaging volume Volumen embalaje Volume d'emballage Verpackungsvolumen	Gross weight Peso bruto Poids brut Bruttogewicht	Loading quantity Unidades por contenedor Unités par conteneur Einheiten pro Container
SC-35K	8437009886434	boston-kchair	4	97.5 x 21.3 x 51.1 cm 38.4" x 8.4" x 20.1"	0.106 m ³ 3.743 ft ³	19.26 kg 42.37 lb	Container 40': 2304 Container 40' HC: 2640

Trolley for storing all of Zown's folding chairs and stools.
Carro para el almacenaje de todas las sillas y taburetes plegables zown.
Chariot de rangement de toutes les chaises et tabourets pliants zown.
Lagerwagen für alle Zown-Klappstühle und -hocker.

liamtrolley

TROLLEY CARRO CHARIOT WAGEN



26.23 kg
57.8 lb



POWDER-COATED
STEEL
Grey

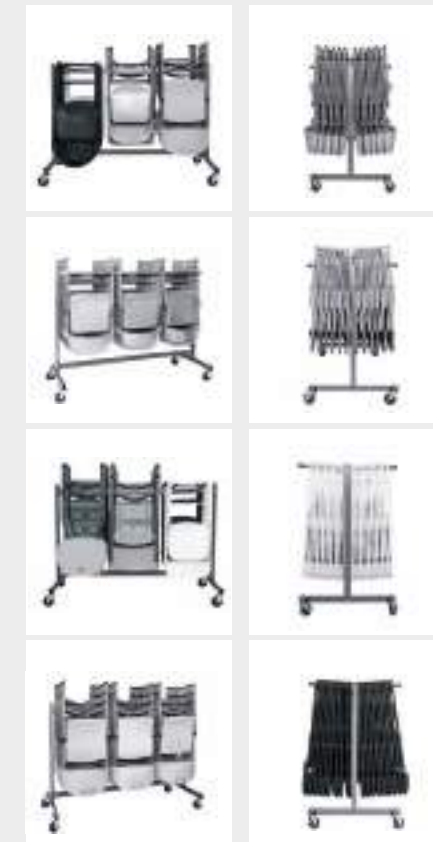

Capacity for a wide range of chairs. 60 alexandra / 60 alex / 30 norman / 30 otto / 24 markus / 36 boston.

Capacidad para una amplia variedad de sillas. 60 alexandra / 60 alex / 30 norman / 30 otto / 24 markus / 36 boston.

Capacité pour une large variété de chaises. 60 alexandra / 60 alex / 30 norman / 30 otto / 24 markus / 36 boston.

Aufnahmevermögen für verschiedenste Stühle. 60 alexandra / 60 alex / 30 norman / 30 otto / 24 markus / 36 boston.



Integrated brakes in 2 of its 4 wheels.

Frenos incorporados en 2 de sus 4 ruedas.

2 des 4 roulettes sont munies d'un frein.

Mit Bremsen an 2 der 4 Rädern.



Scratch protector to prevent scratches on walls.

Anti-scratch. Protector para evitar rayar las paredes.

Anti-rayures. Protection évitant les rayures sur les murs.

Kratzschutz. Schutzvorrichtung gegen Kratzer an den Wänden.

Code Código Code Code	EAN	Name Nombre Nom Name	Units per box Unidades por caja Unités par boîte Stückzahl pro Packung	Packaging size Medidas embalaje Dimensions emballage Verpackungsmaße	Packaging volume Volumen embalaje Volume d'emballage Verpackungsvolumen	Gross weight Peso bruto Poids brut Bruttogewicht	Loading quantity Unidades por contenedor Unités par conteneur Einheiten pro Container
CB002F005	8436539296713	liamtrolley	1	176.5 x 88.3 x 15.2 cm 69.5" x 34.7" x 6"	0.236 m ³ 8.334 ft ³	31.3 kg 68.8 lb	Container 40': 252 Container 40' HC: 290

Upholstered, stackable convention chair.
Silla de convenciones tapizada apilable.
Chaise pour conférences, tapissée et empilable.
Veranstaltungsstuhl, tapeziert, stapelbar.

igorchair

CHAIR SILLA CHAISE STUHL



6.28 kg
13.84 lb



225 kg
500 lb



H83.8 cm
H33"

L44.5 x W50.2 cm
L17.5" x W19.7"

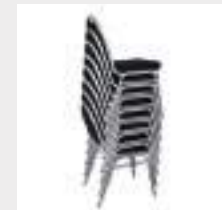

Stackable
Apilable
Empilable
Stapelbar

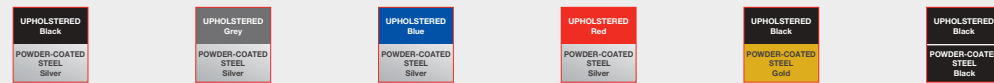

thetextilecollection

stretch



classic

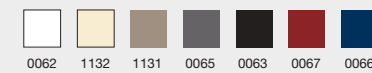

sashes

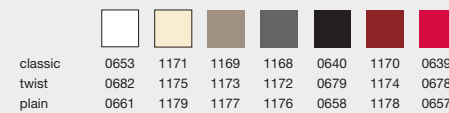

Code Código Code Code	EAN	Name Nombre Nom Name	Units per box Unidades por caja Unités par boîte Stückzahl pro Packung	Packaging size Medidas embalaje Dimensions emballage Verpackungsmaße	Packaging volume Volumen embalaje Volume d'emballage Verpackungsvolumen	Gross weight Peso bruto Poids brut Bruttogewicht	Loading quantity Unidades por contenedor Unités par conteneur Einheiten pro Container
SKC-41-S/BK	8436539290223	igorchair silver/black	15	66 x 45.7 x 228 cm 26" x 18" x 90"	0.686 m ³ 24.225 ft ³	97 kg 213.40 lb	Container 40': 1350
SKC-41-S/R	8436539290230	igorchair silver/red					
SKC-41-S/BU	8436539290247	igorchair silver/blue					
SKC-41-S/G	8436539290216	igorchair silver/grey					
SKC-41-GD/BK	8436539290254	igorchair gold/black	17	66 x 47.6 x 260.4 cm 26" x 18.7" x 102.5"	0.818 m ³ 28.887 ft ³	109.08 kg 240.47 lb	Container 40' HC: 1530
SKC-41-BK/BK	8436539290261	igorchair black/black					

Display rack that can be taken apart for five tables.
Expositor desmontable para cinco mesas.
Présentoir démontable pour cinq tables.
Zerlegbarer Ausstellungsständer für bis zu fünf Tische.

displayrack

DISPLAY RACK EXPOSITOR SUPPORT
D'EXPOSITION AUSSTELLUNGSTÄNDER



11.2 kg
24.7 lb



POWER-COATED
STEEL
Grey



H71.1 cm
H28"

L64.1 x W61 cm
L25.2" x W24"



Easy to assemble and disassemble.
Fácil de montar y desmontar.
Facile à monter et à démonter.
Einfach auf- und abzubauen.



Code Código Code Code	EAN	Name Nombre Nom Name	Units per box Unidades por caja Unités par boîte Stückzahl pro Packung	Packaging size Medidas embalaje Dimensions emballage Verpackungsmaße	Packaging volume Volumen embalaje Volume d'emballage Verpackungsvolumen	Gross weight Peso bruto Poids brut Bruttogewicht	Loading quantity Unidades por contenedor Unités par conteneur Einheiten pro Container
RA-287	8437010781308	displayrack	1	72.7 x 26 x 66.7 cm 28.6" x 10.2" x 26.2"	0.126 m ³ 4.449 ft ³	13.2 kg 29.04 lb	Container 40': 480 Container 40' HC: 574

Maxchief Europe S.L. reserves the right to modify or remove from the catalogue at any time and without prior notice any of the products described in it. For this reason, we cannot guarantee the availability of the products or that the specifications, colours, forms and other characteristics reproduced coincide at all times and in all details with the real ones. The total or partial reproduction of the content of this publication is strictly prohibited, as well as the images and texts that are the intellectual property of Maxchief Europe S.L., without previous written authorisation.

Maxchief Europe S.L. se reserva el derecho de modificar o descatalogar en cualquier momento y sin previo aviso cualquiera de los modelos descritos en este catálogo. Por ello, no garantiza la disponibilidad de los modelos ni que las especificaciones, colores, formas y demás características que se reproducen coincidan en todo momento y con todo detalle con los reales. Queda prohibida la reproducción total o parcial del contenido de esta publicación, así como de imágenes y textos propiedad intelectual de Maxchief Europe S.L., salvo previa autorización.

Maxchief Europe S.L. se réserve le droit de modifier ou de sortir du catalogue à tout moment et sans préavis n'importe lequel des produits décrits dans ce catalogue. C'est pourquoi elle ne garantit pas la disponibilité des produits. Elle ne garantit pas non plus que les spécifications, les couleurs, les formes et les autres caractéristiques reproduites coïncident à tout moment et dans le moindre détail avec les réelles. Il est interdit de reproduire totalement ou partiellement le contenu de cette publication, ainsi que les images et les textes, propriété intellectuelle de Maxchief Europe S.L., sauf autorisation préalable par écrit.

Maxchief Europe S.L. behält sich das Recht vor, jedes Produkt in diesem Katalog jederzeit und ohne vorherige Ankündigung zu ändern oder aus dem Lieferprogramm zu nehmen. Das Unternehmen gewährleistet daher nicht, dass die einzelnen Produkte verfügbar sind bzw. dass die tatsächlichen Spezifikationen, Farben, Formen und sonstigen Merkmale jederzeit genau mit den angegebenen übereinstimmen. Die vollständige oder teilweise Wiedergabe des Inhalts dieser Publikation sowie der Bilder und Texte, die geistiges Eigentum von Maxchief Europe S.L. sind, ist ohne vorherige schriftliche Genehmigung verboten.



ZOWN CLASSIC COLLECTION SUMMARY RESUMEN COLECCIÓN ZOWN CLASSIC RÉSUMÉ COLLECTION ZOWN CLASSIC ÜBERSICHT KOLLEKTION ZOWN CLASSIC

M183

TABLE MESA TABLE TISCH

183x46xh74 cm
72"x18.1"xh29.1"

Pg28



oxford180

TABLE MESA TABLE TISCH

180x50xh74.3 cm
5.9"x19.7"xh29.3"

Pg29



L120

TABLE MESA TABLE TISCH

121.9x61xh74.3 cm
4"x24"xh29.2"

Pg30



XXLtrolley

TROLLEY CARRO CHARIOT WAGEN

(202+46)x92xh115 cm
(79.6"+18.1")x36.2"xh45.3"

Pg58



XXLmoon

TABLE MESA TABLE TISCH

181.5x181.5xh74.3 cm
5.9"x5.9"xh29.2"

Pg60



XXLcorner

TABLE MESA TABLE TISCH

91.4x91.4xh74.3 cm
3'x3"xh29.2"

Pg56



Ltrolley

TROLLEY CARRO CHARIOT WAGEN

131.7x62xh115 cm
51.9"x24.4"xh45.3"

Pg31



XL150

TABLE MESA TABLE TISCH

152.4x76.2xh74.3 cm
5'x30"xh29.2"

Pg34



XL180

TABLE MESA TABLE TISCH

182.9x75.2xh74.3 cm
6'x29.6"xh29.2"

Pg36



SS60

TABLE MESA TABLE TISCH

61x61xh89 cm
24"x24"xh35"

Pg92



SS120

TABLE MESA TABLE TISCH

122x61xh89 cm
48"x24"xh35"

Pg93



buffettablebase

TABLE MESA TABLE TISCH

183.3x75.2xh74 cm
72.1"x29.6"xh29.1"

Pg40

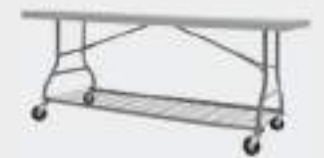

worktop180

TABLE MESA TABLE TISCH

182.9x76.2xh74.3/85.1/90.2/94.3 cm
6'x30"xh29.2"/33.5"/35.5"/37.1"

Pg38



XL240

TABLE MESA TABLE TISCH

243.8x76.2xh74.3 cm
8'x30"xh29.2"

Pg42



XLtrolley

TROLLEY CARRO CHARIOT WAGEN

(193+61)x77xh115 cm
(76"+24")x30.3"x h45.3"

Pg44



planet120

TABLE MESA TABLE TISCH

Ø122xh74.3 cm
Ø4'xh29.2"

Pg64



planet150

TABLE MESA TABLE TISCH

Ø152.4xh74.3 cm
Ø5'xh29.2"

Pg66



planet160

TABLE MESA TABLE TISCH

Ø160xh74.3 cm
Ø63'xh29.2"

Pg68



XLcorner

TABLE MESA TABLE TISCH

75.1x75.1xh74.3 cm
29.56"x29.56"xh29.2"

Pg48



XLmoon

TABLE MESA TABLE TISCH

166.3x166.3xh74.3 cm
5.4'x5.4'xh29.2"

Pg46



topshelf180

SHELF ESTANTE SHELF SHELF

184x30.5xh31 cm
6'x12"xh12.2"

Pg41



planet180

TABLE MESA TABLE TISCH

Ø180.3xh74.3 cm
Ø5.92'xh29.2"

Pg70



planetrolley

TROLLEY CARRO CHARIOT WAGEN

(132+30)x83.2xh102 cm
(52"+11.8")x32.7"xh40.2"

Pg72



cocktail80

TABLE MESA TABLE TISCH

Ø81.3xh110 cm
Ø32"xh43.3"

Pg74



XXL90

TABLE MESA TABLE TISCH

91.4x91.4xh74.3 cm
36"x36"xh29.2"

Pg50



XXL200

TABLE MESA TABLE TISCH

198.2x91.4xh74.3 cm
6.5'x36"xh29.2"

Pg52



XXL240

TABLE MESA TABLE TISCH

240x91.4xh74.3 cm
8'x36"xh29.2"

Pg54



praxis80

TABLE MESA TABLE TISCH

Ø81.3xh74.3 cm
Ø32"xh29.2"

Pg78



bistrot70

TABLE MESA TABLE TISCH

68.6x68.6xh74.3 cm
27"x27"xh29.5"

Pg80



NEW

cocktailrolley

TROLLEY CARRO CHARIOT WAGEN

121x89xh101 cm
47.6"x35"xh39.6"

Pg82



sharp**table**

TABLE **MESA** TABLE **TISCH**

182.9x76.2xh74.3 cm
6'x30"xh29.2"

Pg87



sharp**bench180**

BENCH **BANCO** BANC **BANK**

184x30.5xh44.5 cm
6'x12"xh17.5"

Pg86



sharp**bench240**

BENCH **BANCO** BANC **BANK**

244.5x29.4xh44.2 cm
96.26"x11.5"xh17.4"

Pg85



alex**chair**

CHAIR **SILLA** CHAISE **STUHL**

45.1x43.8xh80.3 cm
17.75"x17.24"xh31.6"

Pg96



alex**trolley**

TROLLEY **CARRO** CHARIOT **WAGEN**

95.4x47.5xh196.8 cm
37.5"x18.7"xh77.5"

Pg102



munich**70**

TABLE **MESA** TABLE **TISCH**

220x67xh77 cm
86.6"x26.4"xh30.3"

Pg90



munich**50**

TABLE **MESA** TABLE **TISCH**

220x50xh77 cm
86.6"x19.7"xh30.3"

Pg88

NEW



munich**bench**

BENCH **BANCO** BANC **BANK**

220x30xh48 cm
86.6"x11.8"xh18.9"

Pg91



alexandra**chair**

CHAIR **SILLA** CHAISE **STUHL**

45.1x43.2xh87.5 cm
17.7"x17"xh34.33"

Pg100



alexandra**trolley**

TROLLEY **CARRO** CHARIOT **WAGEN**

113.5x47.5xh196.8 cm
44.7"x18.7"xh77.5"

Pg103



otto**chair**

CHAIR **SILLA** CHAISE **STUHL**

47x54xh84.8 cm
18.5"x21.26"xh33.38"

Pg106



otto**trolley**

TROLLEY **CARRO** CHARIOT **WAGEN**

110x47.7xh190 cm
43.3"x18.8"xh74.8"

Pg107



display**rack**

DISPLAY RACK **EXPOSITOR** SUPPORT
D'EXPOSITION **AUSSTELLUNGSTÄNDER**

64.1x61xh71.1 cm
25.2"x24"xh28"

Pg113



alex-k**chair**

CHAIR **SILLA** CHAISE **STUHL**

46.4x43.8xh80.3 cm
18.26"x17.24"xh31.6"

Pg97



boston-k**chair**

CHAIR **SILLA** CHAISE **STUHL**

49.5x50.8xh75 cm
19.5"x20"xh29.6"

Pg110



oktober**175**

BENCH **BANCO** BANC **BANK**

175.3x29.2xh46.4 cm
69"x11.5"xh18.3"

Pg84



norman**trolley**

TROLLEY **CARRO** CHARIOT **WAGEN**

110x48xh190 cm
43.3"x18.9"xh74.8"

Pg109



alvar**stool**

STOOL **TABURETE** TABOURET **HOCKER**

51.8x56.6xh104.6 cm
20.4"x22.3"xh41.1"

Pg76



alexandra-k**chair**

CHAIR **SILLA** CHAISE **STUHL**

46.6x53.8xh87.5 cm
18.3"x21.2"xh34.33"

Pg101



liam**trolley**

TROLLEY **CARRO** CHARIOT **WAGEN**

175x79xh123.5 cm
68.9"x31.1"xh48.6"

Pg111



norman**chair**

CHAIR **SILLA** CHAISE **STUHL**

47x50.7xh85.8 cm
18.5"x19.96"xh33.78"

Pg108



igor**chair**

CHAIR **SILLA** CHAISE **STUHL**

44.5x50.2xh83.8 cm
17.5"x19.7"xh33"

Pg112



PARTIAL TABLE SKIRT

Code	Product name	Suitable for the furniture	Use	Shape	Colour	GTIN-13	GTIN-14	Pcs. per bag	Bags per carton	G. per bag	lb. per bag	GW per carton (kg)	GW per carton (lb)	Polybag size cm	L bag	W bag	H bag	Polybag size in	L bag	W bag	H bag	Carton size cm	L carton	W carton	H carton	Carton size in	L carton	W carton	H carton
partial table skirts / faldones parciales mesa / jupon partiel table / tischvorhänge																													
SPTT-00566	paramount partial 150 table skirt	L152 x H74.3 cm L5' x H29.2"	table skirt	paramount	white	8436539291961	18436539291968	1	12	800	1.76	10.8	23.76	87	40	3	34.3	15.7	1.2	80	50	15	31.5	19.7	5.9				
SPTT-00567	paramount partial 150 table skirt	L152 x H74.3 cm L5' x H29.2"	table skirt	paramount	black	8436539291978	18436539291975	1	12	800	1.76	10.8	23.76	87	40	3	34.3	15.7	1.2	80	50	15	31.5	19.7	5.9				
SPTT-00569	paramount partial 150 table skirt	L152 x H74.3 cm L5' x H29.2"	table skirt	paramount	anthracite	8436539295884	18436539295881	1	12	800	1.76	10.8	23.76	87	40	3	34.3	15.7	1.2	80	50	15	31.5	19.7	5.9				
SPTT-00570	paramount partial 150 table skirt	L152 x H74.3 cm L5' x H29.2"	table skirt	paramount	blue	8436539295891	18436539295898	1	12	800	1.76	10.8	23.76	87	40	3	34.3	15.7	1.2	80	50	15	31.5	19.7	5.9				
SPTT-00571	paramount partial 150 table skirt	L152 x H74.3 cm L5' x H29.2"	table skirt	paramount	burgundy	8436539295907	18436539295904	1	12	800	1.76	10.8	23.76	87	40	3	34.3	15.7	1.2	80	50	15	31.5	19.7	5.9				
SPTT-01180	paramount partial 150 table skirt	L152 x H74.3 cm L5' x H29.2"	table skirt	paramount	sand	8436539303176	18436539303173	1	12	800	1.76	10.8	23.76	87	40	3	34.3	15.7	1.2	80	50	15	31.5	19.7	5.9				
SPTT-01181	paramount partial 150 table skirt	L152 x H74.3 cm L5' x H29.2"	table skirt	paramount	ecru	8436539303183	18436539303180	1	12	800	1.76	10.8	23.76	87	40	3	34.3	15.7	1.2	80	50	15	31.5	19.7	5.9				
SPTT-00572	paramount partial 180 table skirt	L183 x H74.3 cm L6' x H29.2"	table skirt	paramount	white	8436539291985	18436539291982	1	10	900	1.98	10.3	22.66	88	45	3	34.6	17.7	1.2	80	50	15	31.5	19.7	5.9				
SPTT-00573	paramount partial 180 table skirt	L183 x H74.3 cm L6' x H29.2"	table skirt	paramount	black	8436539291992	18436539291999	1	10	900	1.98	10.3	22.66	88	45	3	34.6	17.7	1.2	80	50	15	31.5	19.7	5.9				
SPTT-00575	paramount partial 180 table skirt	L183 x H74.3 cm L6' x H29.2"	table skirt	paramount	anthracite	8436539295921	18436539295928	1	10	900	1.98	10.3	22.66	88	45	3	34.6	17.7	1.2	80	50	15	31.5	19.7	5.9				
SPTT-00576	paramount partial 180 table skirt	L183 x H74.3 cm L6' x H29.2"	table skirt	paramount	blue	8436539295938	18436539295935	1	10	900	1.98	10.3	22.66	88	45	3	34.6	17.7	1.2	80	50	15	31.5	19.7	5.9				
SPTT-00577	paramount partial 180 table skirt	L183 x H74.3 cm L6' x H29.2"	table skirt	paramount	burgundy	8436539295945	18436539295942	1	10	900	1.98	10.3	22.66	88	45	3	34.6	17.7	1.2	80	50	15	31.5	19.7	5.9				
SPTT-01182	paramount partial 180 table skirt	L183 x H74.3 cm L6' x H29.2"	table skirt	paramount	sand	8436539303190	18436539303197	1	10	900	1.98	10.3	22.66	88	45	3	34.6	17.7	1.2	80	50	15	31.5	19.7	5.9				
SPTT-01183	paramount partial 180 table skirt	L183 x H74.3 cm L6' x H29.2"	table skirt	paramount	ecru	8436539303206	18436539303203	1	10	900	1.98	10.3	22.66	88	45	3	34.6	17.7	1.2	80	50	15	31.5	19.7	5.9				
SPTT-00578	paramount partial 200 table skirt	L200 x H74.3 cm L6.5' x 29.2"	table skirt	paramount	white	8436539292005	18436539292002	1	10	950	2.09	10.8	23.76	87	44	4	34.3	17.3	1.6	80	50	15	31.5	19.7	5.9				
SPTT-00579	paramount partial 200 table skirt	L200 x H74.3 cm L6.5' x 29.2"	table skirt	paramount	black	8436539292012	18436539292019	1	10	950	2.09	10.8	23.76	87	44	4	34.3	17.3	1.6	80	50	15	31.5	19.7	5.9				
SPTT-00581	paramount partial 200 table skirt	L200 x H74.3 cm L6.5' x 29.2"	table skirt	paramount	anthracite	8436539295969	18436539295966	1	10	950	2.09	10.8	23.76	87	44	4	34.3	17.3	1.6	80	50	15	31.5	19.7	5.9				
SPTT-00582	paramount partial 200 table skirt	L200 x H74.3 cm L6.5' x 29.2"	table skirt	paramount	blue	8436539295976	18436539295973	1	10	950	2.09	10.8	23.76	87	44	4	34.3	17.3	1.6	80	50	15	31.5	19.7	5.9				
SPTT-00583	paramount partial 200 table skirt	L200 x H74.3 cm L6.5' x 29.2"	table skirt	paramount	burgundy	8436539295983	18436539295980	1	10	950	2.09	10.8	23.76	87	44	4	34.3	17.3	1.6	80	50	15	31.5	19.7	5.9				
SPTT-01184	paramount partial 200 table skirt	L200 x H74.3 cm L6.5' x 29.2"	table skirt	paramount	sand	8436539303213	18436539303210	1	10	950	2.09	10.8	23.76	87	44	4	34.3	17.3	1.6	80	50	15	31.5	19.7	5.9				
SPTT-01185	paramount partial 200 table skirt	L200 x H74.3 cm L6.5' x 29.2"	table skirt	paramount	ecru	8436539303220	18436539303227	1	10	950	2.09	10.8	23.76	87	44	4	34.3	17.3	1.6	80	50	15	31.5	19.7	5.9				
SPTT-00584	paramount partial 240 table skirt	L244 x H74.3 cm L8' x H29.2"	table skirt	paramount	white	8436539292029	18436539292026	1	8	1100	2.43	10	22	86	40	5	33.9	15.7	2.0	80	50	15	31.5	19.7	5.9				
SPTT-00585	paramount partial 240 table skirt	L244 x H74.3 cm L8' x H29.2"	table skirt	paramount	black	8436539292036	18436539292033	1	8	1100	2.43	10	22	86	40	5	33.9	15.7	2.0	80	50	15	31.5	19.7	5.9				
SPTT-00587	paramount partial 240 table skirt	L244 x H74.3 cm L8' x H29.2"	table skirt	paramount	anthracite	8436539296003	18436539296000	1	8	1100	2.43	10	22	86	40	5	33.9	15.7	2.0	80	50	15	31.5	19.7	5.9				
SPTT-00588	paramount partial 240 table skirt	L244 x H74.3 cm L8' x H29.2"	table skirt	paramount	blue	8436539296010	18436539296017	1	8	1100	2.43	10	22	86	40	5	33.9	15.7	2.0	80	50	15	31.5	19.7	5.9				
SPTT-00589	paramount partial 240 table skirt	L244 x H74.3 cm L8' x H29.2"	table skirt	paramount	burgundy	8436539296027	18436539296024	1	8	1100	2.43	10	22	86	40	5	33.9	15.7	2.0	80	50	15	31.5	19.7	5.9				
SPTT-01186	paramount partial 240 table skirt	L244 x H74.3 cm L8' x H29.2"	table skirt	paramount	sand	8436539303237	18436539303234	1	8	1100	2.43	10	22	86	40	5	33.9	15.7	2.0	80	50	15	31.5	19.7	5.9				
SPTT-01187	paramount partial 240 table skirt	L244 x H74.3 cm L8' x H29.2"	table skirt	paramount	ecru	8436539303244	18436539303241	1	8	1100	2.43	10	22	86	40	5	33.9	15.7	2.0	80	50	15	31.5	19.7	5.9				

Code	Product name	Suitable for the furniture	Use	Shape	Colour	GTIN-13	GTIN-14	Pcs. per bag	Bags per carton	G. per bag	Lb. per bag	GW per carton (kg)	GW per carton (lb)	Polybag size cm	L bag	W bag	H bag	Polybag size in	L bag	W bag	H bag	Carton size cm	L carton	W carton	H carton	Carton size in	L carton	W carton	H carton
partial table skirts / faldones parciales mesa / jupon partiel table / tischvorhänge																													
SPTT-00590	paramount partial XL table skirt	L76 x H74.3 cm L30" x H29.2"	table skirt	paramount	white	8436539292043	18436539292040	1	20	450	0.99	10.3	22.66	85	41	1	33.5	16.1	0.4	80	50	15	31.5	19.7	5.9				
SPTT-00591	paramount partial XL table skirt	L76 x H74.3 cm L30" x H29.2"	table skirt	paramount	black	8436539292050	18436539292057	1	20	450	0.99	10.3	22.66	85	41	1	33.5	16.1	0.4	80	50	15	31.5	19.7	5.9				
SPTT-00593	paramount partial XL table skirt	L76 x H74.3 cm L30" x H29.2"	table skirt	paramount	anthracite	8436539296041	18436539296048	1	20	450	0.99	10.3	22.66	85	41	1	33.5	16.1	0.4	80	50	15	31.5	19.7	5.9				
SPTT-00594	paramount partial XL table skirt	L76 x H74.3 cm L30" x H29.2"	table skirt	paramount	blue	8436539296058	18436539296055	1	20	450	0.99	10.3	22.66	85	41	1	33.5	16.1	0.4	80	50	15	31.5	19.7	5.9				
SPTT-00595	paramount partial XL table skirt	L76 x H74.3 cm L30" x H29.2"	table skirt	paramount	burgundy	8436539296065	18436539296062	1	20	450	0.99	10.3	22.66	85	41	1	33.5	16.1	0.4	80	50	15	31.5	19.7	5.9				
SPTT-01188	paramount partial XL table skirt	L76 x H74.3 cm L30" x H29.2"	table skirt	paramount	sand	8436539303251	18436539303258	1	20	450	0.99	10.3	22.66	85	41	1	33.5	16.1	0.4	80	50	15	31.5	19.7	5.9				
SPTT-01189	paramount partial XL table skirt	L76 x H74.3 cm L30" x H29.2"	table skirt	paramount	ecru	8436539303268	18436539303265	1	20	450	0.99	10.3	22.66	85	41	1	33.5	16.1	0.4	80	50	15	31.5	19.7	5.9				
SPTT-00614	paramount partial XXL table skirt	L91 x H74.3 cm L36" x H29.2"	table skirt	paramount	white	8436539292128	18436539292125	1	10	550	1.21	6.5	14.3	87	45	1	34.3	17.7	0.4	80	50	15	31.5	19.7	5.9				
SPTT-00615	paramount partial XXL table skirt	L91 x H74.3 cm L36" x H29.2"	table skirt	paramount	black	8436539292135	18436539292132	1	10	550	1.21	6.5	14.3	87	45	1	34.3	17.7	0.4	80	50	15	31.5	19.7	5.9				
SPTT-00617	paramount partial XXL table skirt	L91 x H74.3 cm L36" x H29.2"	table skirt	paramount	anthracite	8436539296201	18436539296208	1	10	550	1.21	6.5	14.3	87	45	1	34.3	17.7	0.4	80	50	15	31.5	19.7	5.9				
SPTT-00618	paramount partial XXL table skirt	L91 x H74.3 cm L36" x H29.2"	table skirt	paramount	blue	8436539296218	18436539296215	1	10	550	1.21	6.5	14.3	87	45	1	34.3	17.7	0.4	80	50	15	31.5	19.7	5.9				
SPTT-00619	paramount partial XXL table skirt	L91 x H74.3 cm L36" x H29.2"	table skirt	paramount	burgundy	8436539296225	18436539296222	1	10	550	1.21	6.5	14.3	87	45	1	34.3	17.7	0.4	80	50	15	31.5	19.7	5.9				
SPTT-01190	paramount partial XXL table skirt	L91 x H74.3 cm L36" x H29.2"	table skirt	paramount	sand	8436539303275	18436539303272	1	10	550	1.21	6.5	14.3	87	45	1	34.3	17.7	0.4	80	50	15	31.5	19.7	5.9				
SPTT-01191	paramount partial XXL table skirt	L91 x H74.3 cm L36" x H29.2"	table skirt	paramount	ecru	8436539303282	18436539303289	1	10	550	1.21	6.5	14.3	87	45	1	34.3	17.7	0.4	80	50	15	31.5	19.7	5.9				



napkins / servilletas / serviettes / servietten

SPTT-00638	table napkin	napkin	50 x 50 cm 19.7" x 19.7"	napkin	cotton	white	8436539292203	18436539292200	10	25	690	1.52	18	39.6	34	23	3	13.4	9.1	1.2	50	40	30	19.7	15.7	11.8
------------	--------------	--------	-----------------------------	--------	--------	-------	---------------	----------------	----	----	-----	------	----	------	----	----	---	------	-----	-----	----	----	----	------	------	------



The scene shot for the cover of this catalogue was undertaken by professionals in a controlled environment and purely for advertising purposes. The chairs are not designed to be used in the manner shown in the photograph. Do not under any circumstances attempt to reproduce the photographed scene and do not use ZOWN® products for any purpose other than the one for which they have been manufactured and marketed, in accordance with the product's recommendations and warnings regarding its use. The manufacturer shall not be liable for any losses, damages or injuries resulting from the improper use of the product or from the failure to comply with the product's instructions.

La escena fotografiada en la portada de este catálogo ha sido efectuada por profesionales en un entorno controlado y con fines puramente publicitarios. Las sillas no han sido diseñadas para el uso expuesto en la imagen. No intente reproducir, bajo ningún concepto, la escena fotografiada y no emplee los productos ZOWN® para un uso diferente al habitual para el que han sido fabricados y comercializados, de conformidad con las recomendaciones y advertencias de uso del producto. El fabricante no será responsable por ninguna pérdida, daño o lesión resultado del uso indebido del producto o por el incumplimiento de las instrucciones del mismo.

La scène photographiée sur la couverture de ce catalogue a été effectuée par des professionnels dans un environnement contrôlé et à des fins strictement publicitaires. Les chaises n'ont pas été conçues pour l'utilisation exposée dans l'image. N'essayez pas de reproduire, sous aucun concept, la scène photographiée et n'utilisez pas les produits ZOWN® pour une utilisation différente de celle pour laquelle ils ont été fabriqués et commercialisés, conformément aux recommandations et aux avertissements d'usage du produit. Le fabricant ne sera considéré responsable d'aucune perte, d'aucun dommage ou d'aucune lésion résultant de l'utilisation incorrecte du produit ou du non-respect de ses instructions.

Das auf der Titelseite dieses Katalogs dargestellte Foto wurde von professionellen Fotografen in einer kontrollierten Umgebung und ausschließlich zu Werbezwecken aufgenommen. Die Stühle wurden nicht zu der auf dem Bild dargestellten Verwendung konzipiert. Versuchen Sie unter keinen Umständen die fotografierte Szene nachzustellen und verwenden Sie die Produkte von ZOWN® nur für den üblichen Verwendungszweck, für den sie hergestellt und vertrieben werden, in Übereinstimmung mit den Empfehlungen und Warnhinweisen zum Einsatz des Produkts. Der Hersteller übernimmt keinerlei Haftung für Verluste, Schäden oder Verletzungen, die sich aus der unsachgemäßen Verwendung bzw. die Nichtbeachtung der Anleitungen ergeben.



Si este documento no incluye las marcas o productos que fabrica o distribuye tu empresa, notifícanoslo en contacto@hosteleria10.com.

Estaremos encantados de incorporarlas.